

DENTAL EL ALETLERİ

DENTAL INSTRUMENTS

ERSOY / ODC

► ersoydental.com

Geçmişten günümüze, Ersoy Dental'ın en önemli gücü müşteri memnuniyetine verdiği önemdir. Şirket, müşteri taleplerini dikkate alarak sürekli olarak ürün yelpazesini güncellemekte ve geliştirmektedir. Aynı zamanda, ülke genelinde geniş bir bayi ağı oluşturarak her bölgenin ihtiyaçlarına hızlı ve etkili bir şekilde cevap vermektedir.

Ersoy Dental, sektördeki tüm yenilikleri yakından takip eden bir vizyonla hareket etmektedir. Teknolojik ve ekonomik gelişmeleri sürekli olarak değerlendirerek ürünlerini şekillendiren firma, bu sayede müşterilerine her zaman en iyi ve en güncel çözümleri sunma konusundaki liderliğini sürdürmektedir.

Misyonlarının temelinde dürüstlük, güvenilirlik, şeffaflık ve yenilikçilik ilkesini benimseyen Ersoy Dental, hekimlerin mutluluğunu ve uzun vadeli kazancını ön planda tutarak sektördeki saygın konumunu korumaktadır. Geçmişten günümüze süregelen bu başarı hikayesi, firmanın kalite standartlarına olan bağlılığı ve müşteri odaklı yaklaşımıyla şekillenmiştir.

Throughout its history, Ersoy Dental's most significant strength has been its emphasis on customer satisfaction. The company consistently updates and improves its product range by considering customer requests. At the same time, it has established a wide network of dealers nationwide, ensuring a rapid and effective response to the needs of every region.

Ersoy Dental operates with a vision that closely follows all innovations in the industry. Continuously evaluating technological and economic developments to shape its products, the company maintains its leadership in providing customers with the best and most up-to-date solutions.

Rooted in the principles of honesty, reliability, transparency, and innovation, Ersoy Dental's mission focuses on prioritizing the happiness of healthcare professionals and their long-term gains, thereby preserving its esteemed position in the industry. This success story, continuing from the past to the present, has been shaped by the company's commitment to quality standards and a customer-centric approach.

ERSOY
DENTAL

Tıbbi Gereçler San. ve Tic. Ltd. Şti

www.ersoydental.com

ODC
CERRAHI ALETLER

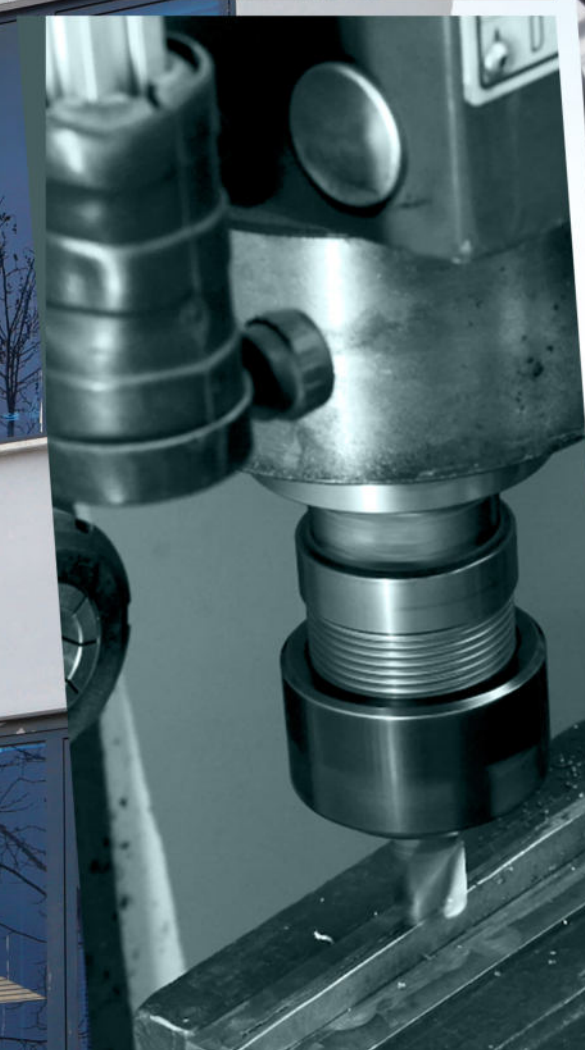

İÇİNDEKİLER | CONTENTS

DAVYELER EXTRACTING FORCEPS	7-18
ELEVATÖRLER ELEVATORS	19-34
MAKASLAR SCISSORS	35-46
PORTEGÜLER NEEDLE	47-58
KLEMPLER FORCEPS	59-70
PENSETLER TWEEZERS	71-84
EKARTÖRLER RETRACTORS	85-116
KEMİK PENSLERİ BONE RONGEURS	117-120
KEMİK KÜRETLERİ BONE CURETTES	121-127
KEMİK EĞELERİ BONE FILES	128
PERİODONTAL KÜRETLER PERIODONTAL CURETTES	129-131
PERİODONTAL BIÇAKLAR PERIODONTAL KNIFES	132-133
GRACEY KÜRETLER GRACEY CURETTES	134-136
TİTANYUM İMPLANT SCALERS TITANIUM IMPLANT SCALERS	137

PERİODONTAL SONDLAR PERIODONTAL PROBES	138-139
PERİODONTAL ÇİZELLER PERIODONTAL CHISELS	140-141
KRETUARLAR CURETTES	142-146
KOMPOZİT ALETLER COMPOSITE INSTRUMENTS	147-155
RUBBER DAM RUBBER DAM	156
AYNALAR MIRRORS	157
SONDLAR PROBES	158
AMALGAM TABANCASI AMALGAM GUN	159-160
MATRİKS TUTUCULAR MATRIX HOLDERS	161-162
SİMAN SİPATÜLLER CEMENT SPATULAS	164
CERRAHİ SURGICAL	167-188
ENJEKTÖRLER INJECTORS	189
ÇENE CERRAHİSİ MAXILLOFACIAL SURGERY	191-232
ORTODONTİ ORTHODONTICS	233-254
KONTEYNER SİSTEMLERİ CONTAINER SYSTEMS	255-261
ÖLÇÜM KAĞIDI MEASURING PAPER	262-265

Türkiye'nin Tek Dental Cerrahi El Aleti Üreticisi

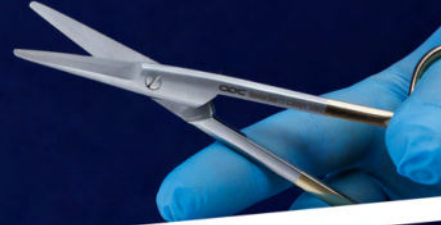

ERSOY DENTAL

TIBBİ GEREÇLER SAN. ve TIC. LTD. ŞTİ.
MEDICAL SUPPLIES INDUSTRY CO. LTD.

ODC
CERRAHI ALETLER
SURGICAL INSTRUMENTS

ECODENT
DENTAL ÇÖZÜMLER
DENTAL SOLUTIONS

+90 362 231 34 34

info@ersoydental.com

ihale@ersoydental.com

İstiklal, 53. Sk. No:39 D:44 Tekkeköy/Samsun

ersoydental.com

ersoydental / odc_global



DAVYELER DIVISIONS

Bu aletler, diřleri yuvalarından ıkarmak iin zel olarak tasarlanmıřtır. ekim pensleri (Davye) nceden lkse olan diřlerde kullanılır ve diřleri yuvasından ıkarmak iin kullanılmamalıdır. Ek olarak, Davye kontroll kuvvetler altında kullanıldıėında alveol kemiėini geniřletebilir.

These instruments are specifically designed for removing teeth from their socket. Extraction forceps are used to previously luxated teeth and should not be used to pull teeth out of their sockets. In addition, the extraction forceps can expand the alveolar bone when used under controlled forces.



ERSOY
DENTAL

ODC
CERRAHI ALETLER

FC100 10'lu Davye Seti



5/3

FC002 Üst Kesici
Upper Incisors

5/3

FC007 Üst Küçük Azı
Upper Premolar

5/3

FC017 Üst Büyük Azı Sağ
Upper Molar Right

5/3

FC018 Üst Büyük Azı Sol
Upper Molar Left

5/3

FC013 Alt Küçük Azı
W

5/3

FC022 Alt Büyük Azı
Lower Molar

5/3

FC033 Alt Kesici ve Kök
Lower Incisors and Roots

5/3

FC51A Üst Kök
Upper Roots

5/3

FC067 Üst Üçüncü Azı
Upper Third Molar

5/3

FC079 Alt Üçüncü Azı
Lower Third Molar

FC200 8'li Çocuk Davye Seti



5/3

FC037 Üst Kesici
Upper Incisors



5/3

FC159 Üst Küçük Azı
Upper Premolar



5/3

FC37R Üst Büyük Azı Sağ
Upper Molar Right



5/3

FC37L Üst Büyük Azı Sol
Upper Molar Left



5/3

FC51S Üst Kök
Upper Roots



5/3

FC33S Alt Dişler ve Kök
Lower Teeth and Roots



5/3

FC13S Alt Küçük Azı
Lower Premolar



5/3

FC22S Alt Büyük Azı
Lower Molar





1/1

FC013 Alt Küçük Azı
Lower Third Molar

1/1

FC033 Üst Üçüncü Azı
Lower Third Molar

1/1

FC51A Üst Üçüncü Azı
Lower Third Molar

1/1

FC067 Üst Üçüncü Azı
Upper Third Molar

1/1

FC079 Alt Üçüncü Azı
Lower Third Molar

FC037 Üst Kesici
Upper Incisors



UPPER

FC159 Üst Küçük Azı
Upper Premolar



UPPER

FC33S Alt Dişler ve Kök
Lower Theeth and Roots



LOWER

FC13S Alt Küçük Azı
Lower Premolar



LOWER

FC39R Üst Büyük Azı Sağ
Upper Molar Right



UPPER

FC39L Üst Büyük Azı Sol
Upper Molar Left



UPPER

1/1
FC22S Alt Büyük Azı
Lower Molar



1/1
FC51S Üst Kök
Upper Roots



1/1
FC046 Alt Kök
Lower Roots



1/1
FC048 Üst Kök
Upper Roots



1/1
FC049 Üst Kök
Upper Roots



1/1
FC087 Üst Büyük Azı, Çürümüş
veya Parçalanmış Dişler
Upper Molar Decayed or Broken
Down Crowns



1/1
FC089 Üst Büyük Azı Sağ
Upper Molars, Right



1/1
FC090 Üst Büyük Azı Sol
Upper Molars, Left



1/1
FC-iMP1 Üst implant
Upper Implant



1/1
FC-iMP2 Alt implant
Lower Implant

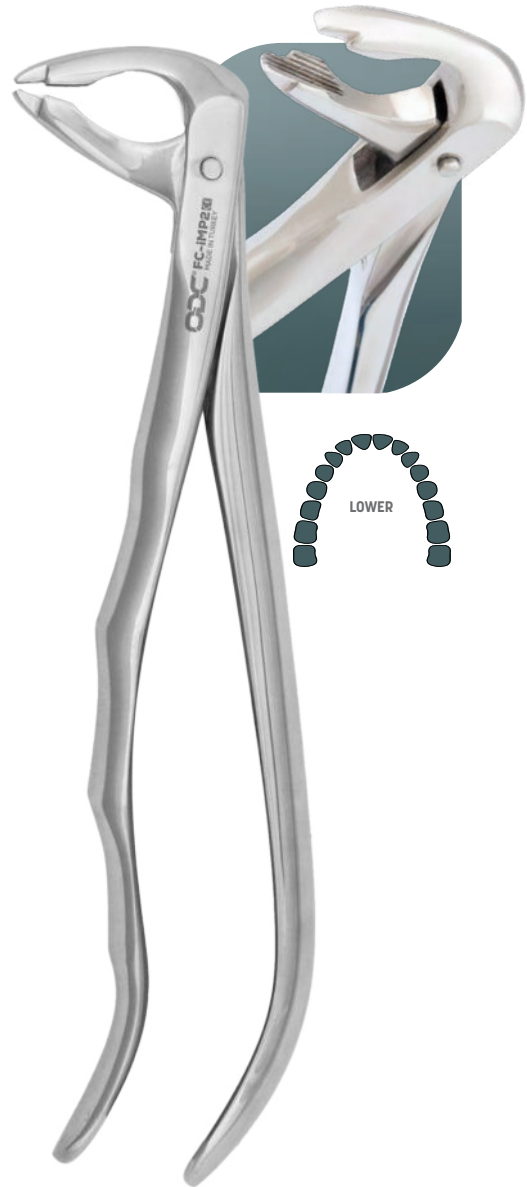

1/1
FC01W Üst Kök
Upper Roots



1/1
FC33A Alt Kök
Lower Roots



1/1
FC02W Alt Kök
Lower Roots



1/1
FC073 Alt Büyük Azı
Lower Molars





1/1
FC074 Alt Küçük Azı
Lower Third Molar



1/1
FC86A Alt Azı
Lower Molar



1/1
FC01S Üst
Upper

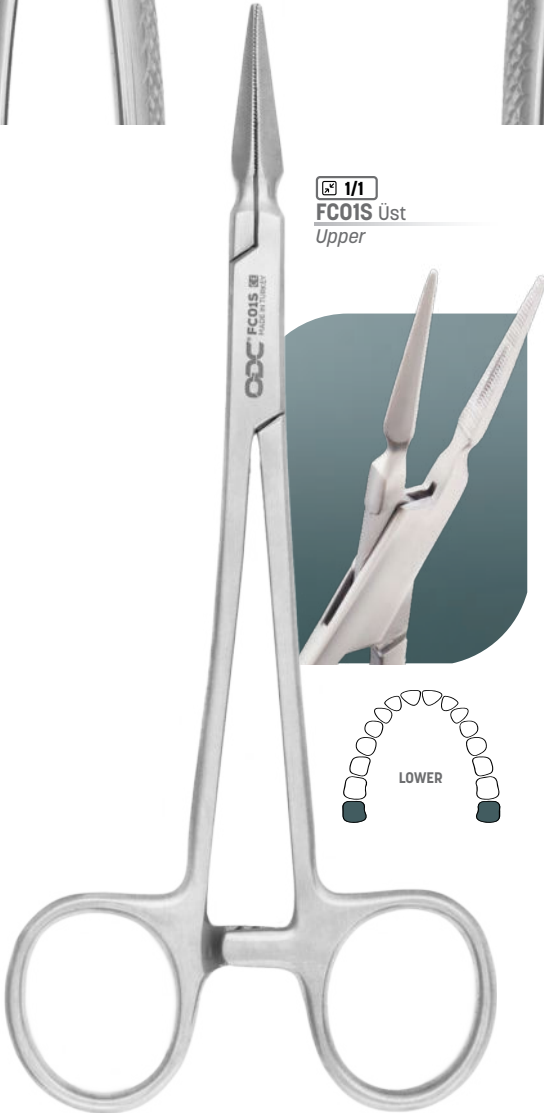

1/1
FC02S Alt
Lower



ELEVATÖRLER ELEVATORS

Bir diřin veya tutulan kklerin ıkarılması sırasında kaldıra olarak kullanılması amalanan, elde tutulan, manuel, diřçilik cerrahi bir alettir. Tipik olarak, distal alıřma ucunda gl ancak ince bir biaa sahip tek para bir alettir veya merkezi bir sap ile ift ulu olabilir.

It is a hand-held, manual, dental surgical instrument intended to be used as a lever during the extraction of a tooth or retained roots. It is typically a one-piece instrument with a strong but slender blade at the distal working end, or it may be double-tipped with a central handle.



ERSOY
DENTAL

ODC
CERRAHI ALETLER



2 mm

3 mm

4 mm

5 mm

4 mm

1/1

1/1

1/1

1/1

1/1

RT02B

RT03B

RT04B

RT11B

RT07W

BEIN

WHITE

3 mm

3 mm

4 mm

4 mm

5 mm

5 mm

2 mm

1/1

1/1

1/1

1/1

1/1

1/1

1/1

RT04L

RT05L

RT06L

RT07L

RT08L

RT09L

RT10L

2 mm

1/1

RT11L



LUSSATORE



1,5 mm



1/1

RT01H
150 mm
SOL/LEFT

1,5 mm

2,5 mm



1/1

RT02H
150 mm
SOL/LEFT

1,5 mm

2,5 mm



1/1

RT03H
150 mm
SAĞ/RIGHT

2,5 mm

1,5 mm



1/1

RT07H
185 mm

2,5 mm



1/1

RT08H
185 mm

1/1

RT04H
150 mm

1/1

RT05H
150 mm

1/1

RT06H
150 mm

HEIDBRINK

3 mm



1/1

RT01A
155 mm

2,5 mm



1/1

RT02A
155 mm
SOL/LEFT

2,5 mm



1/1

RT03A
155 mm
SAĞ/RIGHT

Lussatore Kök Elevator, dişin ya da kalmış köklerin çekilmesi için kaldıraç olarak kullanılır. Dişi çevreleyen dokuyu diş etleri ile dişin dış kısmı arasında iterek gevşetmek için kullanılır. Bıçak, sapın uzun eksenini etrafında döndürülmesiyle oluşturulan bir kuvveti dişin veya kökün yüzeyine iletir.

Lussatore Root Elevator is used as a lever for the extraction of a tooth or retained roots. It is used to loosen the tissue surrounding the tooth by pushing it between the gums and the outer part of the tooth. The blade transmits a force, generated by rotating the handle around its long axis, to the surface of the tooth or root.

APICAL



2,5 mm

3 mm

2,5 mm

3 mm



RT04A
160 mm

RT05A
160mm

RT06A
160 mm

RT07A
160 mm

APEXO

2,2 mm

2,2 mm

2,2 mm



RT03W
160 mm

RT04W
160 mm

RT05W
160 mm

WARWICK-JAMES

2 mm

3 mm

4 mm



RT01D
160 mm

RT02D
160mm

RT03D
160 mm

DISTAL

2 mm

3 mm

4 mm



RT01M
160 mm

RT02M
160mm

RT03M
160 mm

MESIAL



2,5 mm

3,5 mm

4 mm

RT01L
155 mmRT02L
155mmRT03L
155 mm

LINDA-LEVIAN



RT01K

RT07K SAĞ/RIGHT
135 mmRT08K SOL/LEFT
135 mm

KRALLENHEBER

3,6 mm

3,6 mm

RT01K
ÜST SOL/UPPER LEFTRT02K
ÜST SAĞ/UPPER RIGHT

4,2 mm

4,2 mm

RT03K
ÜST SOL/UPPER LEFTRT04K
ÜST SAĞ/UPPER RIGHT

KOPP



3 mm



1/1

RT01F
150 mm
SOL/LEFT

3 mm



1/1

RT02F
150mm
SAĞ/RIGHT

3 mm



1/1

RT03F
150 mm

FLOHR

3 mm



1/1

RT09H
145 mm

4 mm



1/1

RT10H
145mm

1/1



2 mm



1/1

RT11H
145 mm

3 mm



1/1

RT12H
145 mm

3 mm



1/1

RT13H
145 mm

3 mm



1/1

RT14H
145 mm

HYLIN

SOL/LEFT



1/1

RT01C
155 mm

SAĞ/RIGHT



1/1

RT02C
155mm

CRYER

SOL/LEFT



1/1

RT01S
160 mm

SAĞ/RIGHT



1/1

RT02S
160mm

SELDIN





3 mm



1/1
RT03C
160 mm

3,6 mm



1/1
RT04C
160 mm

4,2 mm



1/1
RT05C
160 mm

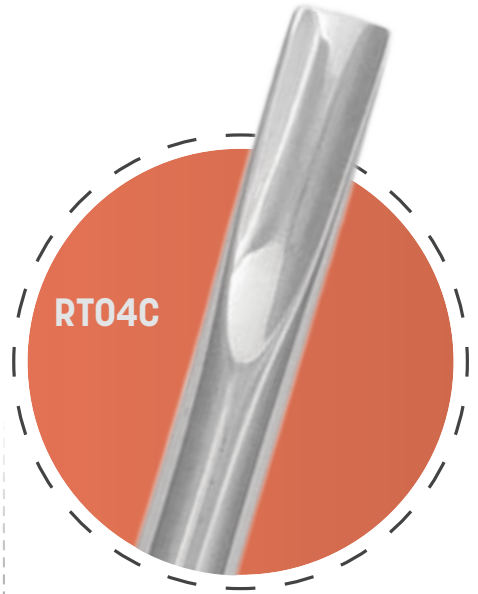

RT04C

3 mm



1/1
RT13C
160 mm

3,6 mm



1/1
RT14C
160 mm

4,2 mm



1/1
RT15C
160 mm

COUPLAND





1/1

RT01W
130 mm
ALT KÖK SOL/
LOWER ROOT LEFT



1/1

RT02W
130 mm
ALT KÖK SAĞ/
LOWER ROOT RIGHT



1/1

RT11W
130 mm
ALT KÖK SOL/
LOWER ROOT LEFT



1/1

RT12W
130 mm
ALT KÖK SAĞ/
LOWER ROOT RIGHT



1/1

RT12L
130 mm

WINTER

LECLUSE

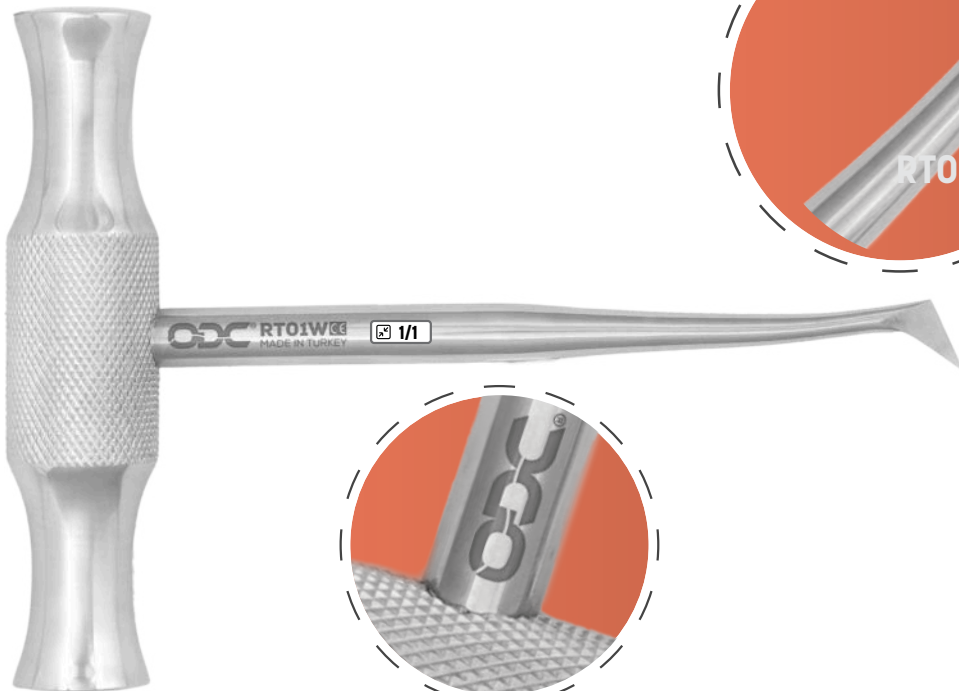

RT01W

RT06B
115 mm
SOL/LEFT

RT05B
115 mm
SAĞ/RIGHT

1/1

1/1

BARRY





SN001
125 mm



SN002
130 mm



SN003
130 mm



SN004
130 mm



SN005
130 mm



SN016
160 mm



SN017
160 mm



SN018
160 mm



SN019
140 mm



SN020



SN021



SN022



PR001
175 mm
BENNETT
☑ 1/1



PR002
170 mm
☑ 1/1



PR003
180 mm
PRICHARD
☑ 1/1



PR004
175 mm
PRICHARD
☑ 1/1



PR005
175 mm
☑ 1/1



PR006
170 mm
MOLT
1/1



PR007
175 mm
1/1



PR008
175 mm
MENECHINI
1/1



PR009
175 mm
GOLDMAN-FOX
1/1



PR010
230 mm
KILIAN
1/1



PR011
190 mm
ROGER
1/1



PR012
190 mm
FREER
1/1



PR013
170 mm
MOLT
1/1



PR014
165 mm
MEAD
1/1



PR015
195 mm
1/1



PR016
185 mm
1/1



PR017
170 mm
1/1



PR018
170 mm
1/1



PR019
165 mm
1/1



PR067
160 mm
MEAD
1/1



PR068
170 mm
1/1



PR070
170 mm
1/1

MAKASLAR SCISSORS

Makas, diř cerrahisi prosedürü sırasında ađız dokusunu, kemiđi ve sutürü kesmek için kullanılan elde tutulan bir diřçilik aletidir. Cihaz bir çene, bir řaft ve bir çalıřtırma kolundan oluřur.

Scissors is a hand-held dental instrument used to cut oral tissue, bone and suture during a dental surgical procedure. The device is comprised of a jaw, a shaft and an operating handle.



ERSOY
DENTAL

ODC
CERRAHI ALETLER

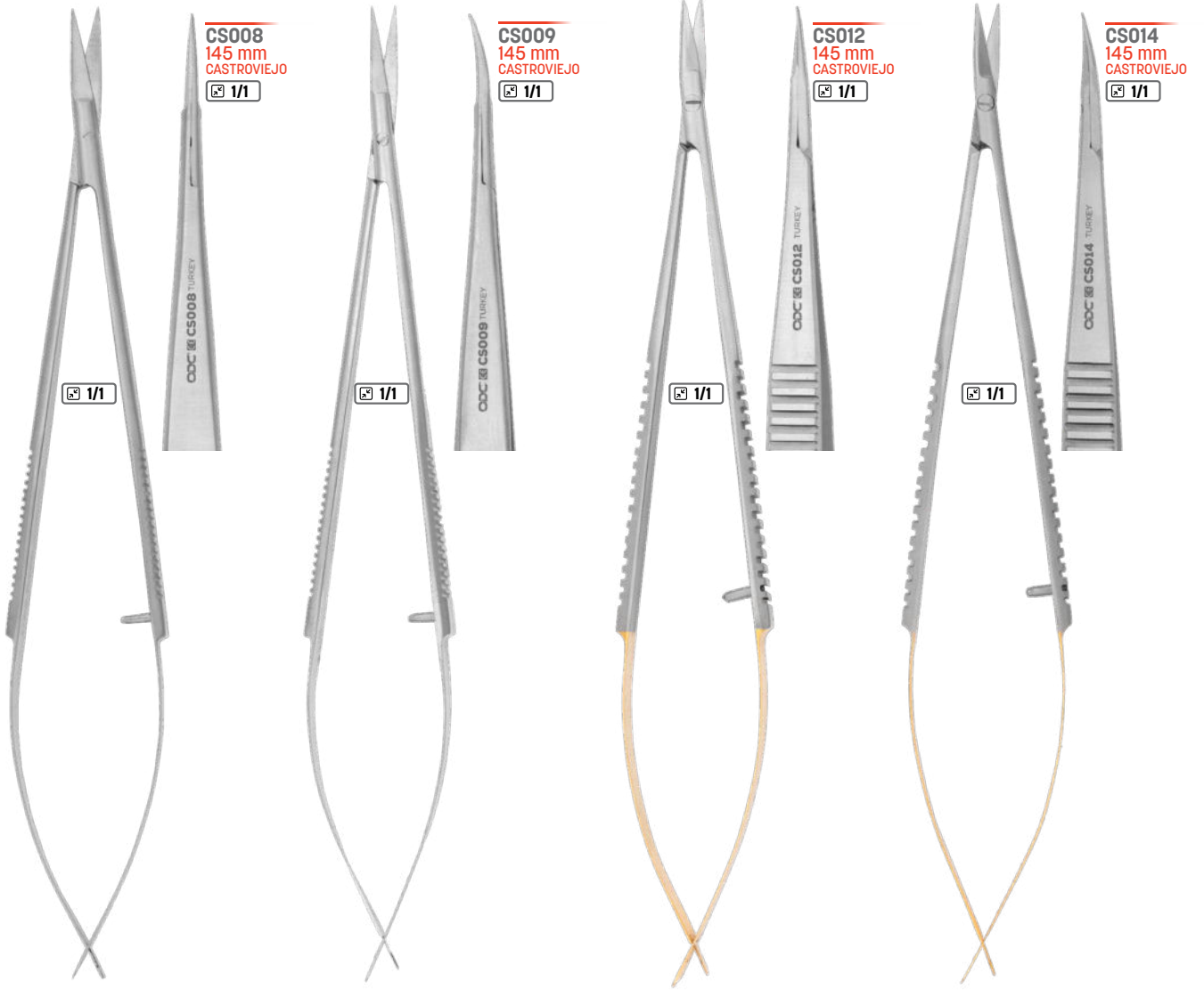

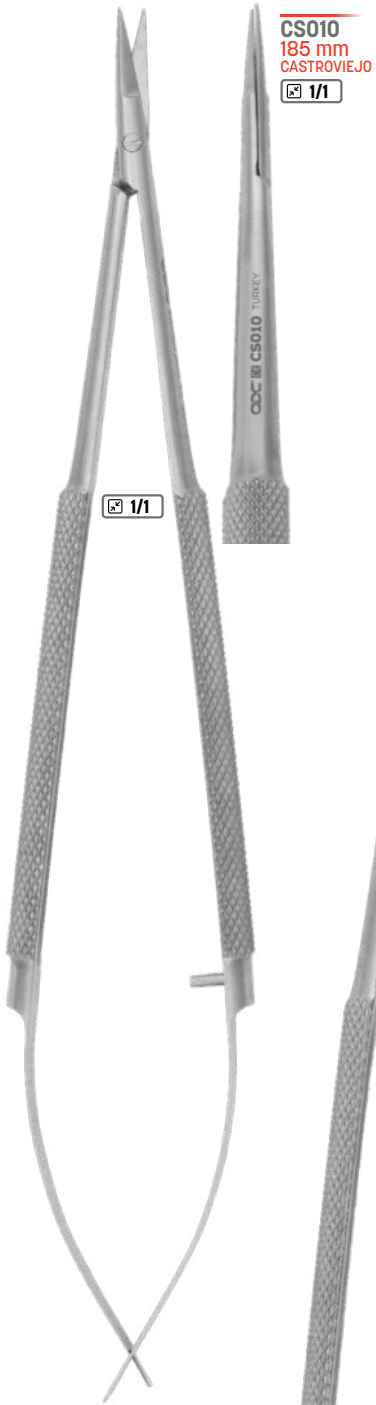

CS010
185 mm
CASTROVIEJO
1/1

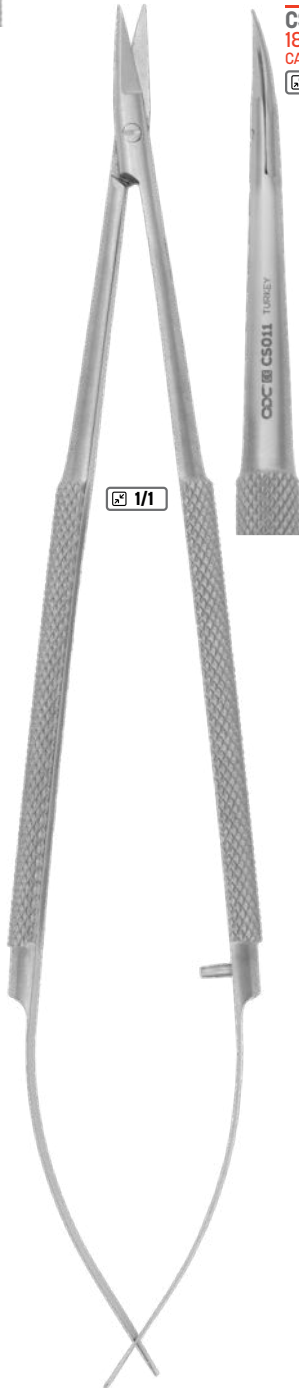

CS011
185 mm
CASTROVIEJO
1/1



CS016
185 mm
CASTROVIEJO
1/1



CS018
185 mm
CASTROVIEJO
1/1



1/1



1/1

CS020
115 mm

1/1

CS021
115 mm

IRIS



1/1

CS022
115 mm

LA GRANGE



1/1

CS023
130 mm

1/1

CS024
130 mm

GOLDMAN-FOX



1/1

CS025
150 mm

1/1

CS026
150 mm

JOSEPH



1/1

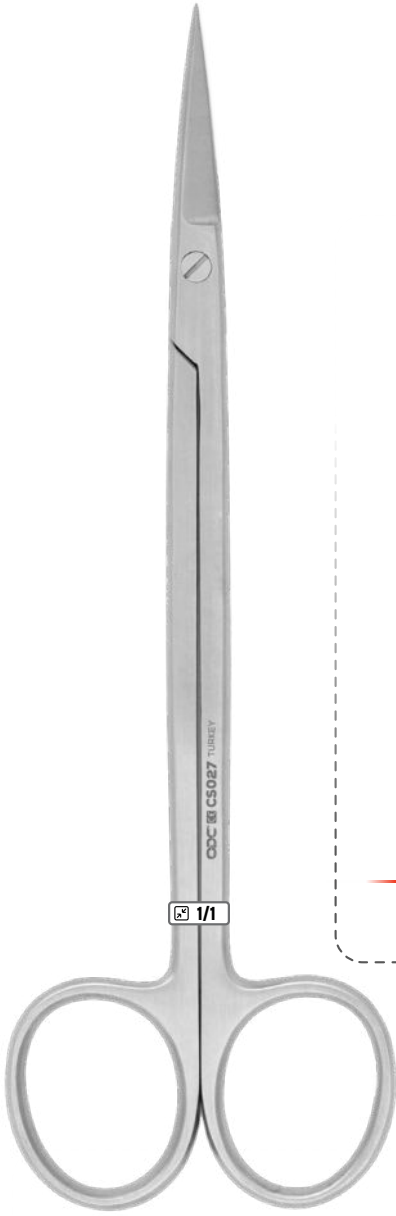

1/1

CS027
160 mm

1/1

CS028
160 mm

KELLY

1/1

CS029
140 mm

1/1

CS030
140 mm

MAYO

1/1

CS031
110 mm

1/1

CS032
110 mm

SİVRİ SHARP

1/1

CS033
110 mm

1/1

CS034
110 mm

KÜNT BKENT



1/1

CS031
110 mm







1/1



1/1

1/1

CS056
115 mm

CS057
115 mm

IRIS TC



CS058
130 mm

CS059
130 mm

GOLDMAN-FOX TC



LA GRANGE TC

CS060
115 mm

1/1

TC

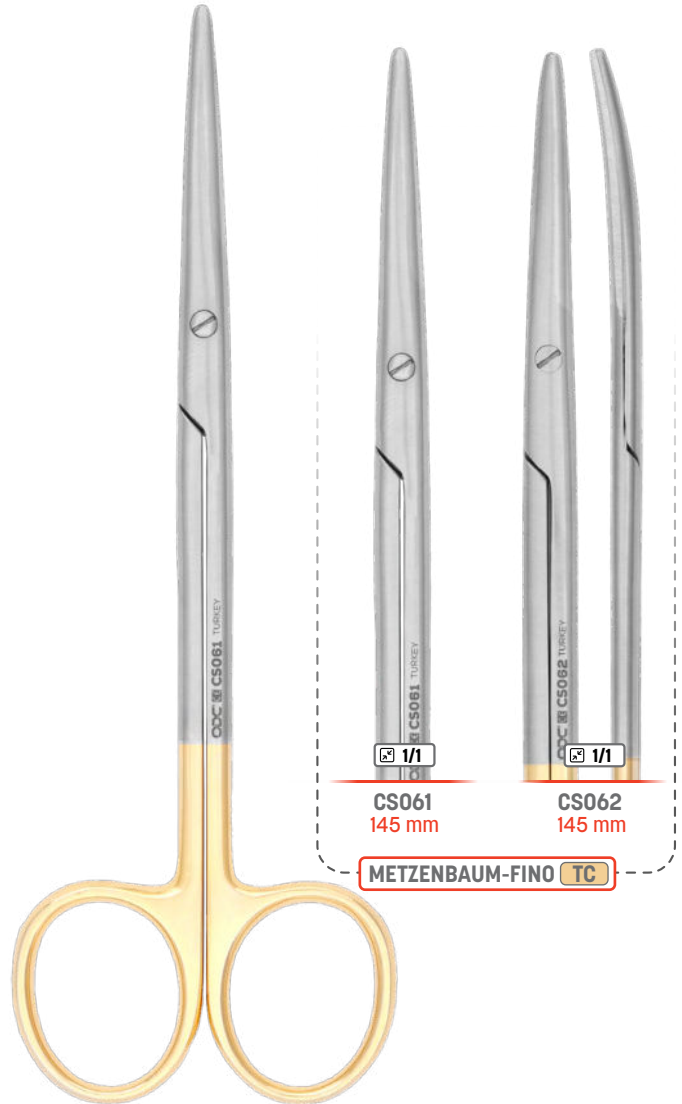

1/1

1/1

CS061
145 mm

CS062
145 mm

METZENBAUM-FINO TC

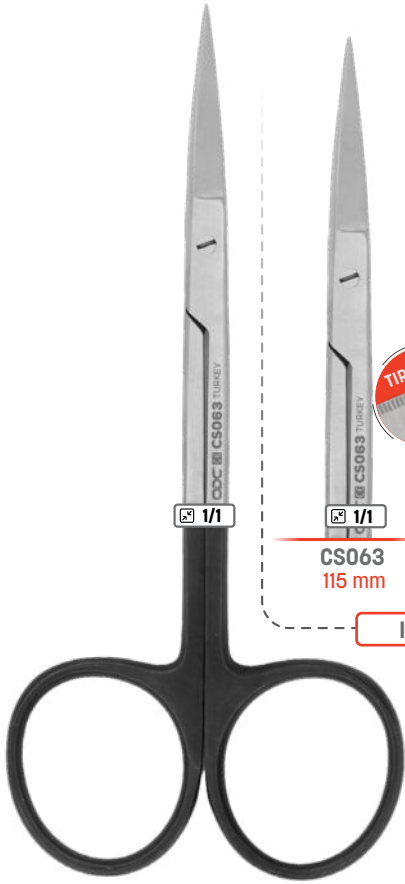

1/1

CS063
115 mmCS064
115 mm

IRIS SC



1/1

1/1

CS065
160 mm
1/1
SC

1/1

CS066
160mm
1/1
SC

1/1

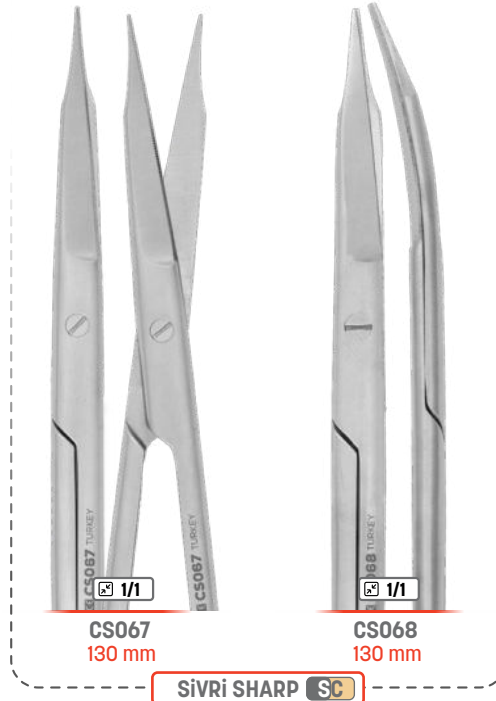

1/1

CS067
130 mmCS068
130 mm

SIVRI SHARP SC

1/1

1/1

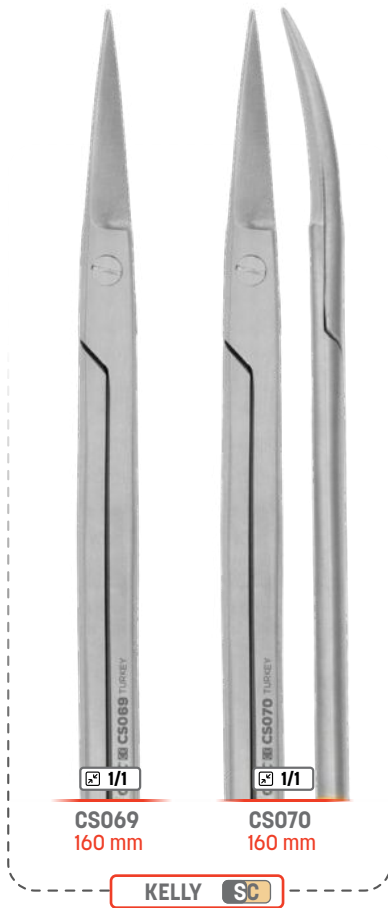

CS069
160 mm

CS070
160 mm

KELLY SC



CS071
115 mm
1/1

LA GRANGE SC

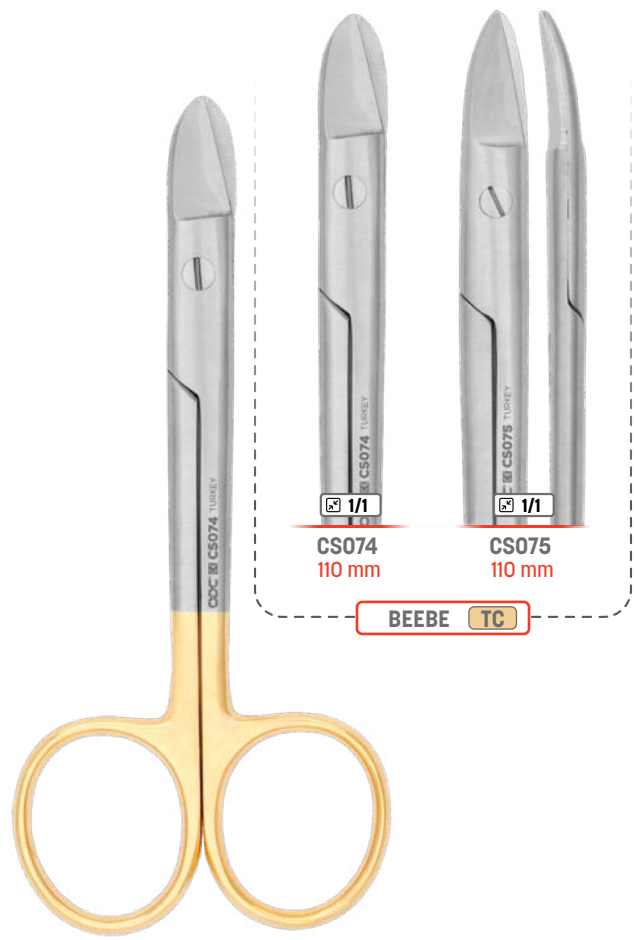
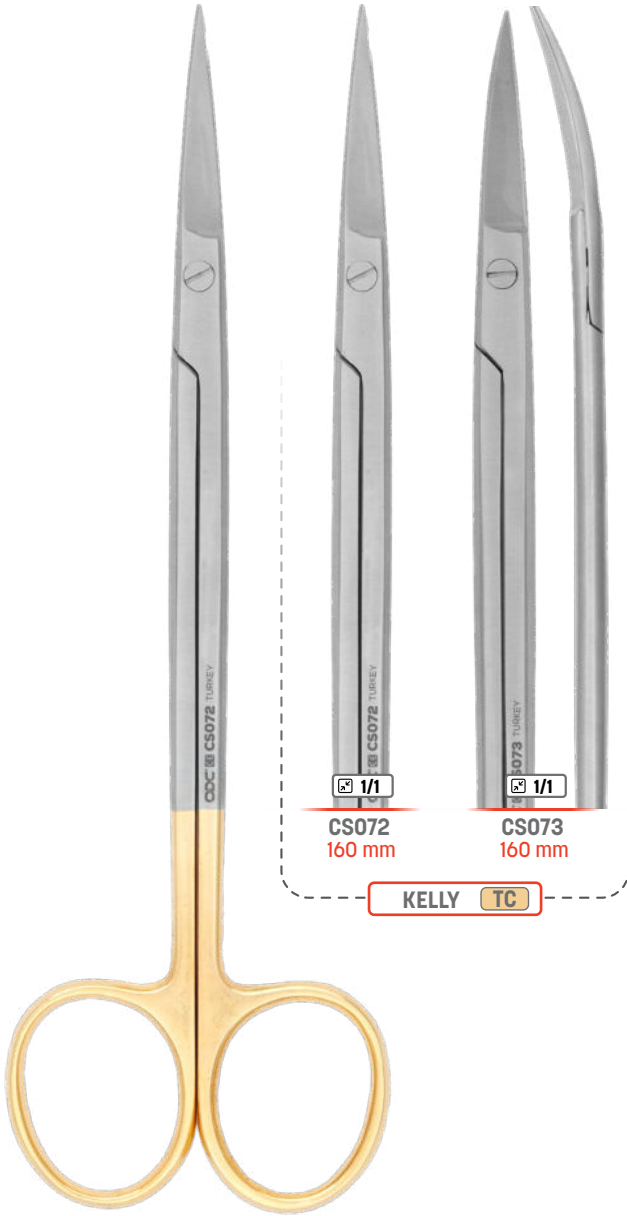



CS129
115 mm
1/1



PORTEGÜLER NEEDLE HOLDERS

Dikiş atma sırasında iğneyi ve ekli dikiş doku boyunca iterken/ çekerken bir dikiş iğnesini kavramak için tasarlanmış, elle tutulan bir cerrahi alettir. Tipik olarak metalden yapılır ve iğnenin daha iyi kavranmasını sağlamak için distal uçta kısa tırtıklı çenelere sahiptir.

It is a hand-held manual surgical instrument designed to grasp a suture needle when pushing/pulling the needle and attached suture through tissue during suturing. It is typically made of metal and has short, serrated jaws at the distal end to provide better grip of the needle.



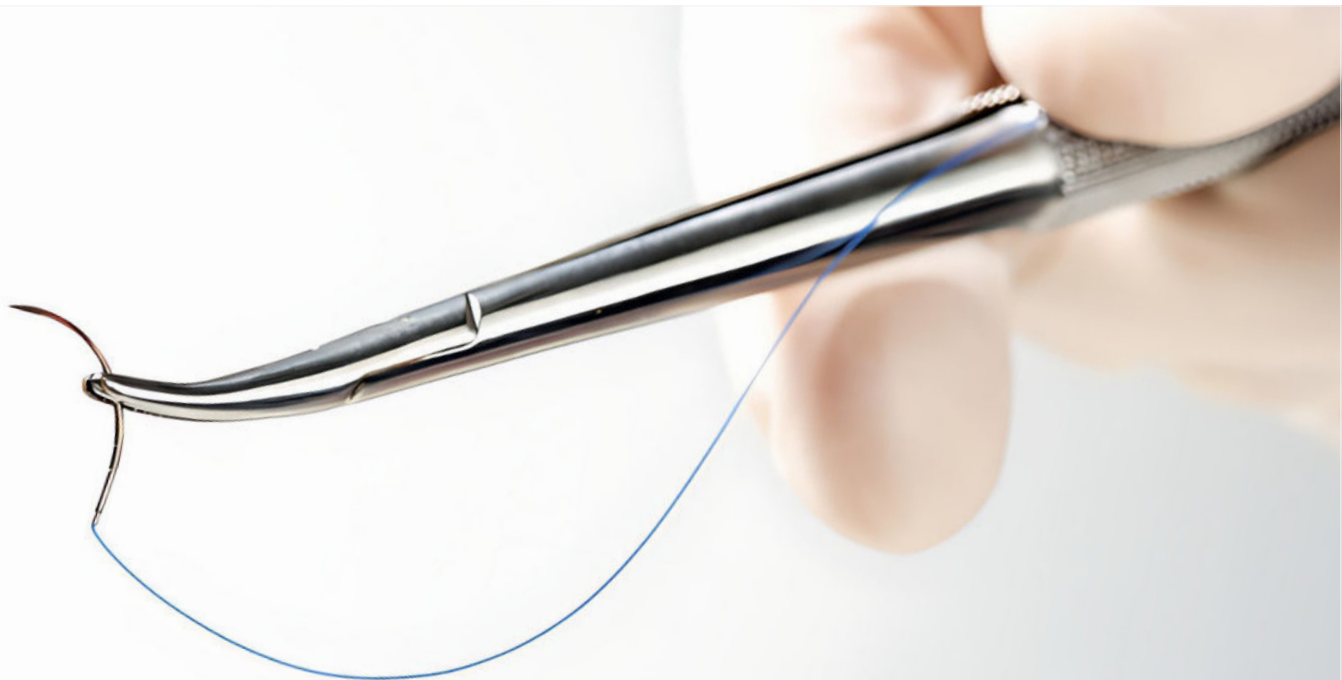
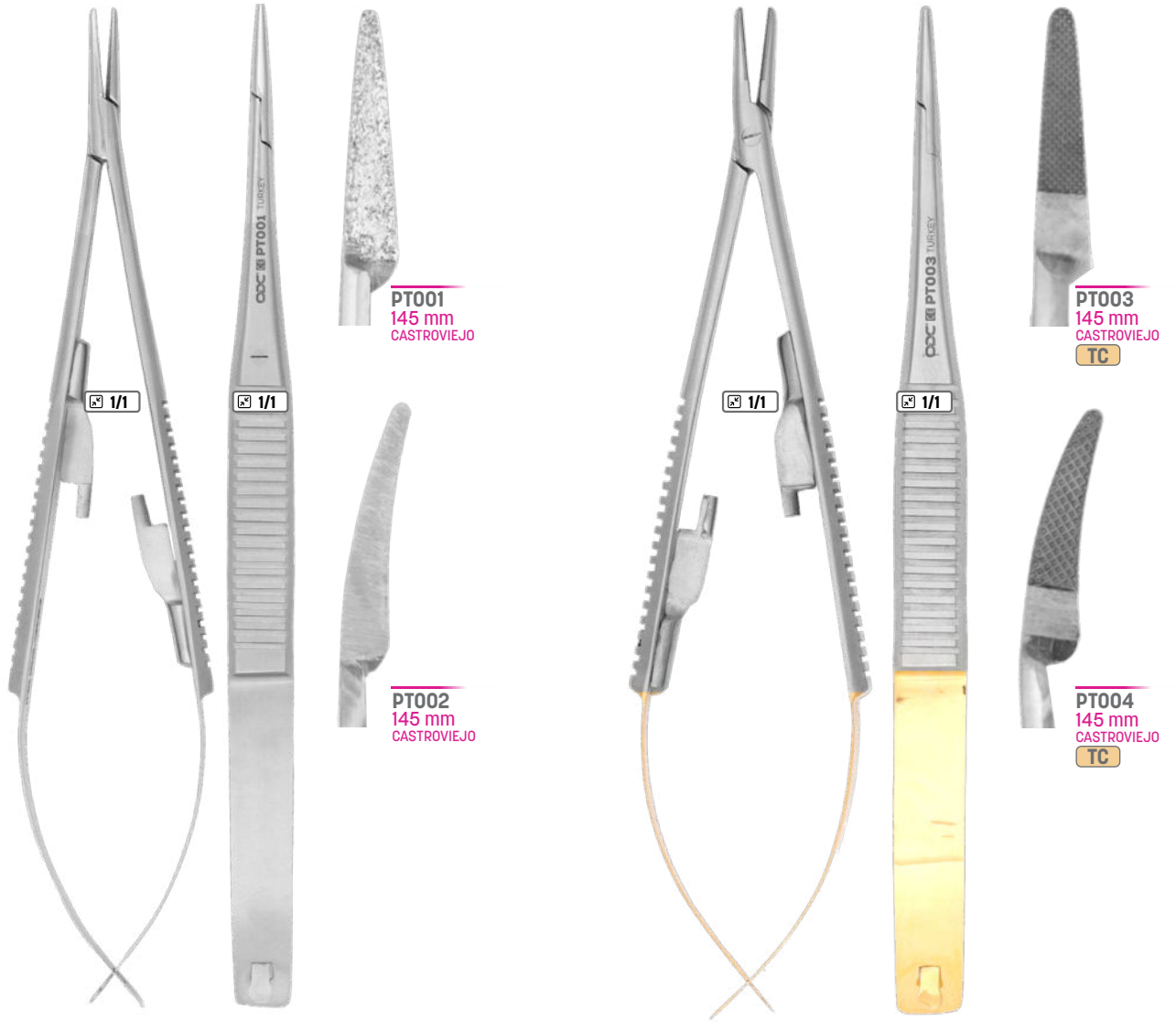

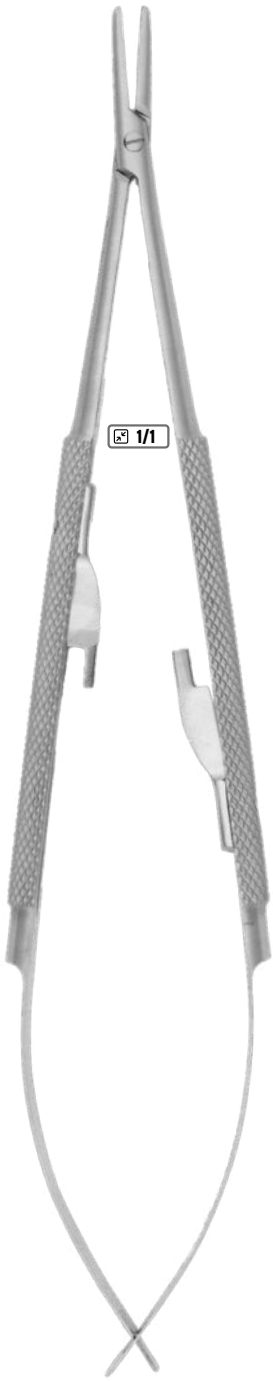

PT007
180 mm
CASTROVIEJO



PT008
180 mm
CASTROVIEJO



PT009
180 mm
CASTROVIEJO



PT010
180 mm
CASTROVIEJO



1/1



PT013
125 mm
DERF



PT014
130 mm
HALSEY



PT016
130 mm
BAUMGARTNER



PT017



PT017
140 mm
HEGAR-OLSEN



1/1



PT018
160 mm
MAYO-HEGAR



PT019
180 mm
MAYO-HEGAR



PT020
150 mm
CRILE MURRAY



PT021
150 mm
CRILE MURRAY



PT022
140 mm
MATHIEU



PT023
170 mm
MATHIEU



PT024
200 mm
MATHIEU



PT025
140 mm
SMAHA



PT027



PT026
150 mm
BABY-CRILE-WOOD
TC

PT027
185 mm
CRILE-WOOD
TC



PT028
160 mm
MAYO-HEGAR
TC



PT029
180 mm
MAYO-HEGAR
TC





PT030
150 mm
FINE SWEDISH
TC

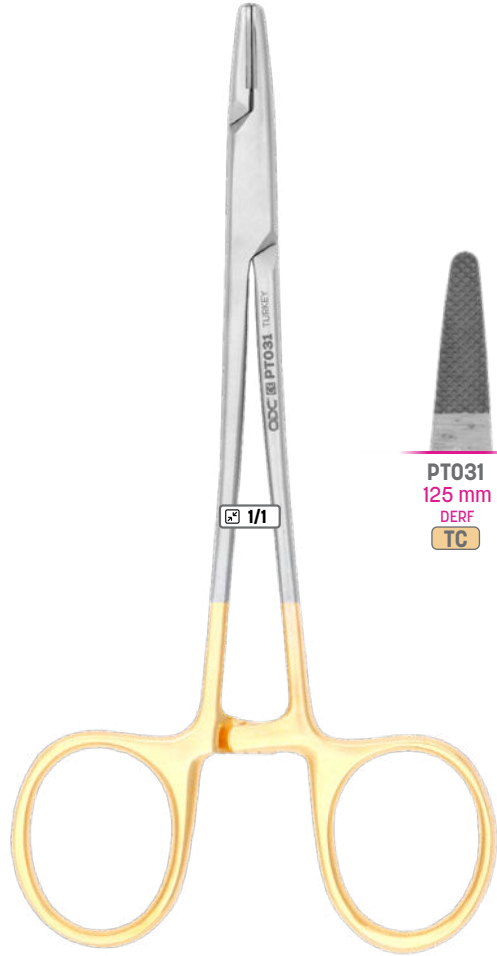

PT031
125 mm
DERF
TC



PT032

PT032
130 mm
HALSEY
TC



1/1



PT033
130 mm
BAUMGARTNER
TC

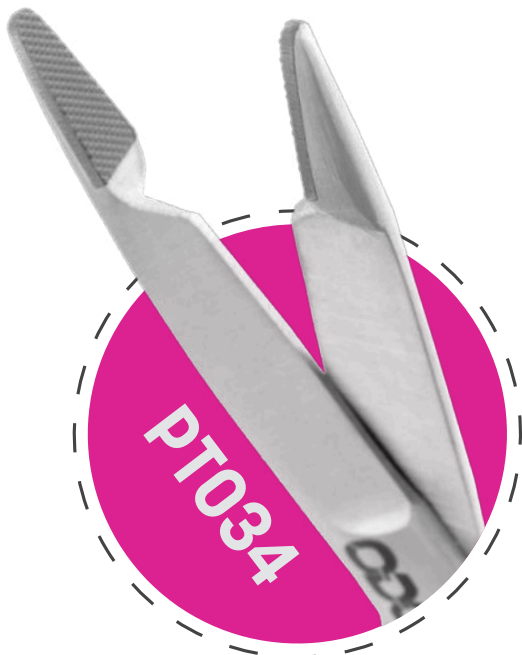

PT034
140 mm
HEGAN-OLSEN
TC





1,5 mm



PT035
140 mm
RYDER
TC

2 mm



PT036
155 mm
RYDER
TC

2,5 mm



PT037
175 mm
RYDER
TC



PT038
140 mm
MATHIEU
TC



PT039
170 mm
MATHIEU
TC



PT040
200 mm
MATHIEU
TC



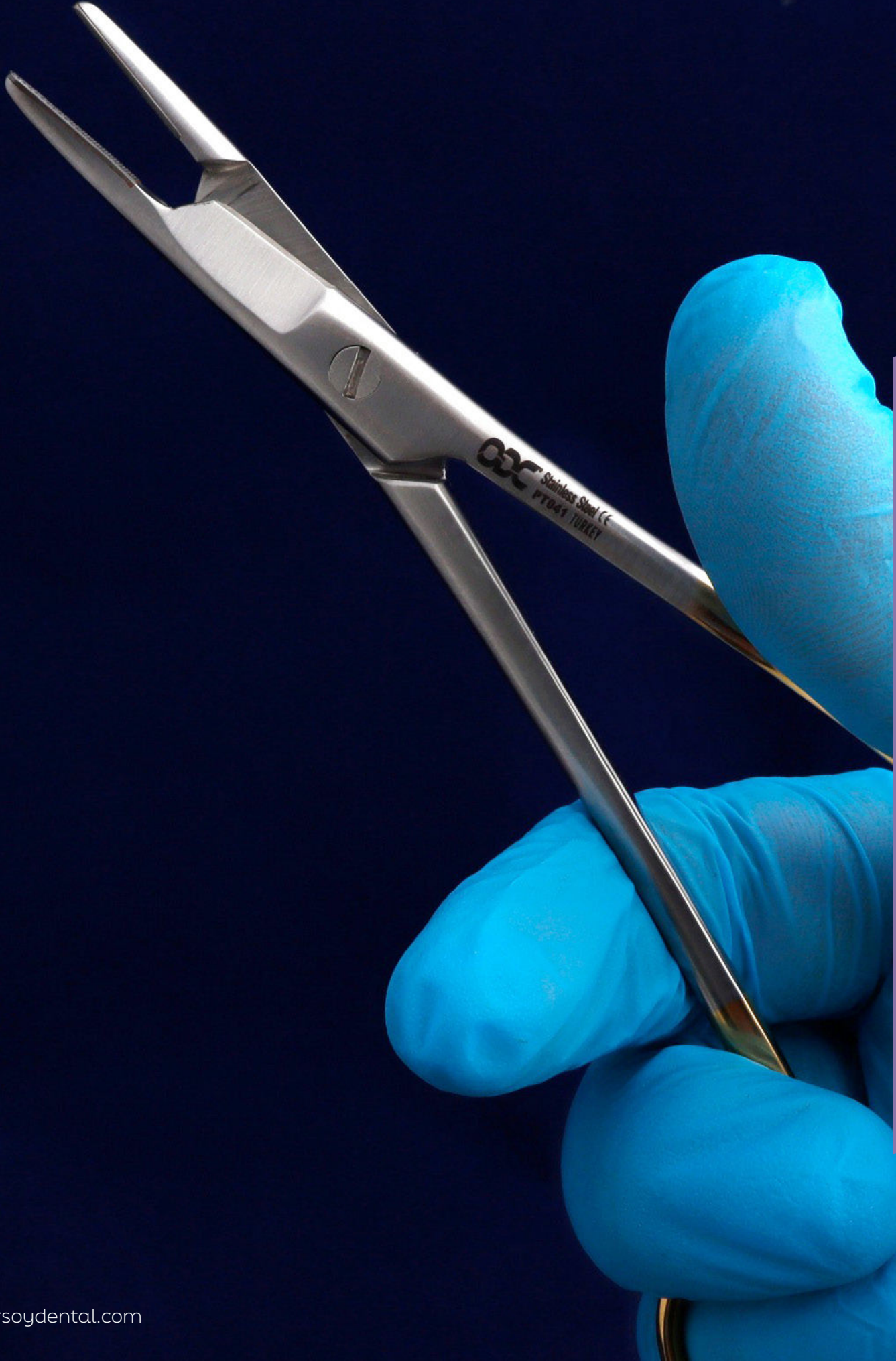

KLEMLER FORCEPS

Klemler, Kanayan damarları kavramak ve tutmak için kullanılır. Klemler damarların daha iyi tutulmasını destekleyen yivli çenelere sahiptir. Klemler uygulama şekline göre boyut ve çene genişliği bakımından farklılık gösterir.

Clamp are used to grip and hold bleeding vessels. Clamps have grooved jaws, which support the better holding of vessels. Depending on the type of application, clamps differ in size and jaw width.





KL001
100 mm
BABY-MOSQUITO



KL002
100 mm
BABY-MOSQUITO



KL003
100 mm
BABY-MOSQUITO



KL004
100 mm
BABY-MOSQUITO

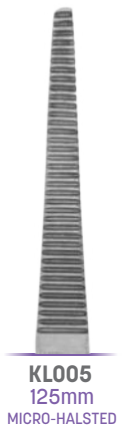
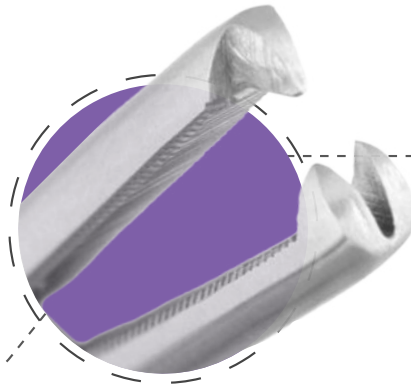

KL005
125mm
MICRO-HALSTED



KL006
125 mm
MICRO-HALSTED



KL007
125 mm
MICRO-HALSTED



KL008
125 mm
MICRO-HALSTED

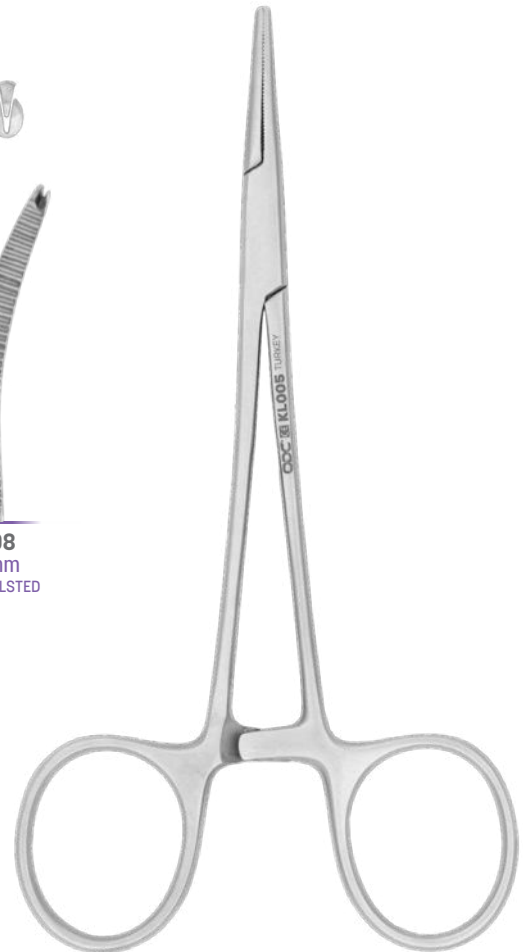



KL009
140 mm
BABY-CRILE



KL010
140 mm
BABY-CRILE



KL011
140 mm
BABY-CRILE

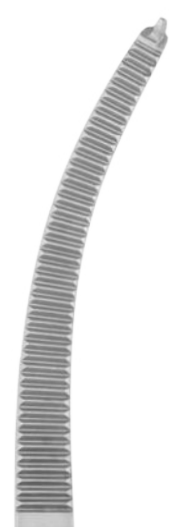

KL012
140 mm
BABY-CRILE



KL013
125mm
HALSTED-MOSQUITO



KL014
125 mm
HALSTED-MOSQUITO



KL015
125 mm
HALSTED-MOSQUITO



KL016
125 mm
HALSTED-MOSQUITO

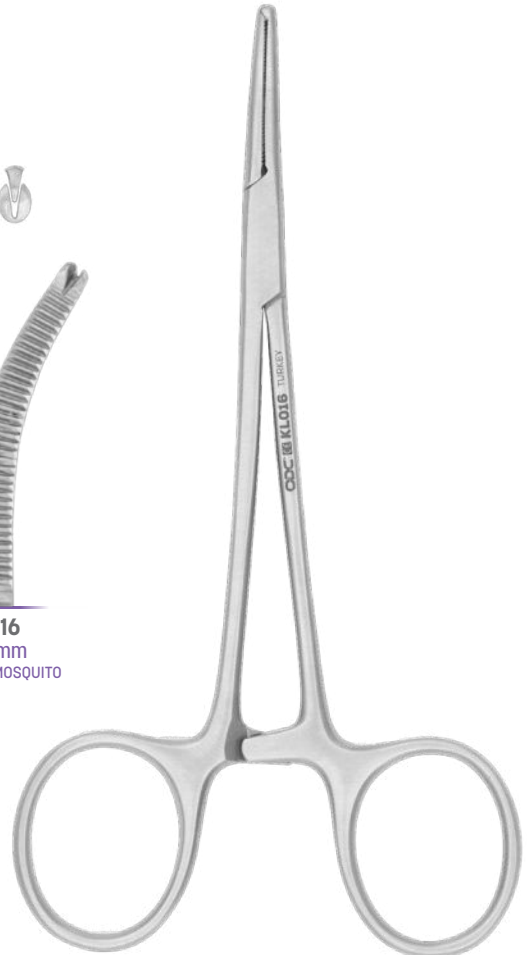



KL017
150 mm
LERICHE



KL018
150 mm
LERICHE



KL019
150 mm
LERICHE



KL020
150 mm
LERICHE

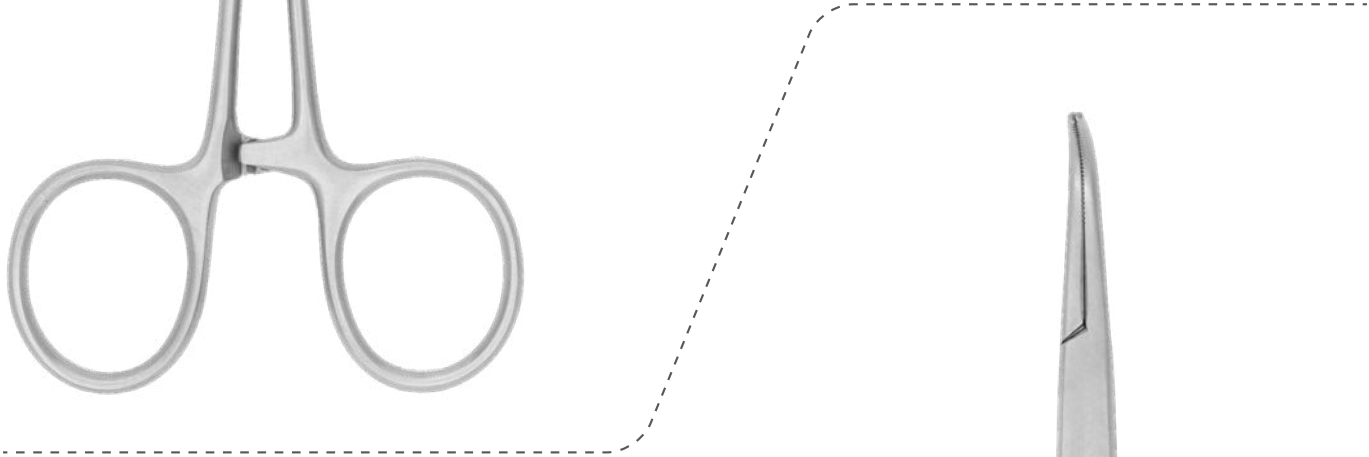

KL021
140 mm
BABY-MIXTER



KL022
180 mm
BABY-MIXTER





KL023
140 mm
CRILE



KL024
140 mm
CRILE

KL023



KL027
130mm
PEAN



KL028
140 mm
PEAN



KL029
130 mm
PEAN



KL030
140 mm
PEAN





KL031
140 mm
KELLY

KL032
140 mm
KELLY



KL033
185mm
HALSTED



KL034
185 mm
HALSTED



KL035
185 mm
HALSTED



KL036
185 mm
HALSTED





KL037
130 mm
KOCHER



KL038
140 mm
KOCHER



KL039
140 mm
KOCHER



KL040



KL040
130 mm
BABY-ALLIS
4x5 Diş
4x5 TEETH





KLO41
155 mm
ALLIS
5x6 DiŞ
5x6 TEETH



KLO42
155 mm
ALLIS
5x6 DiŞ
5x6 TEETH

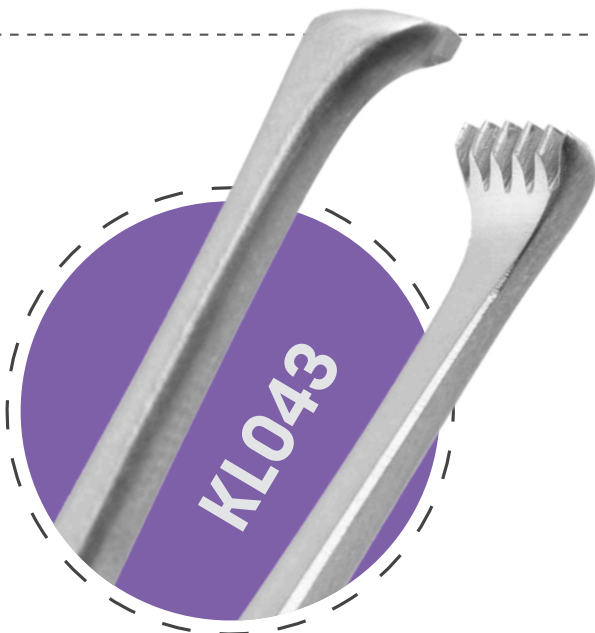

KLO43
155 mm
BOYS-ALLIS
5x6 DiŞ
5x6 TEETH





KLO45
95 mm
LORNA

KLO46
130 mm
LORNA

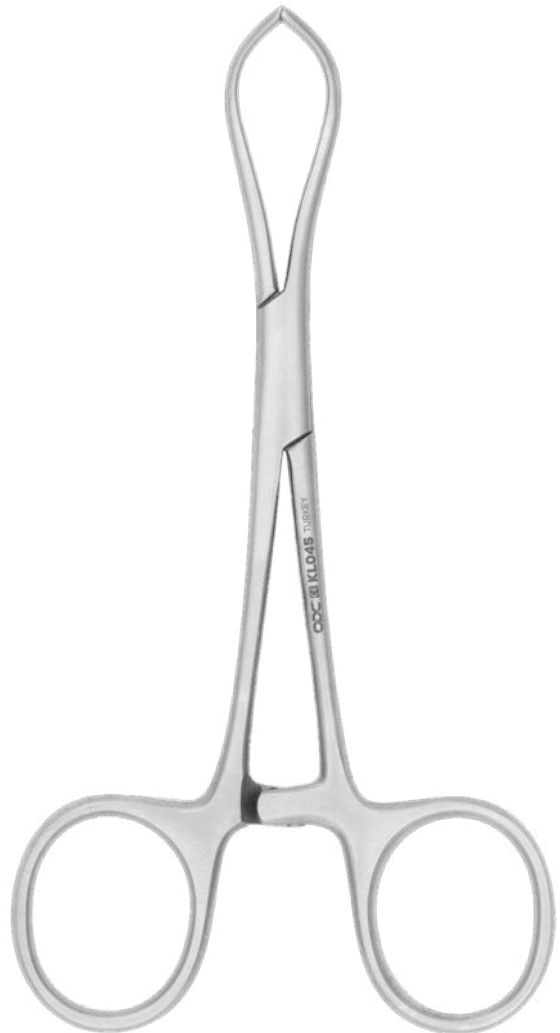



KL047
140 mm
BACKHAUS



KL047



KL048
160 mm
COLLIN



KL049
170 mm
COLLIN





KL050
170 mm
YOUNG

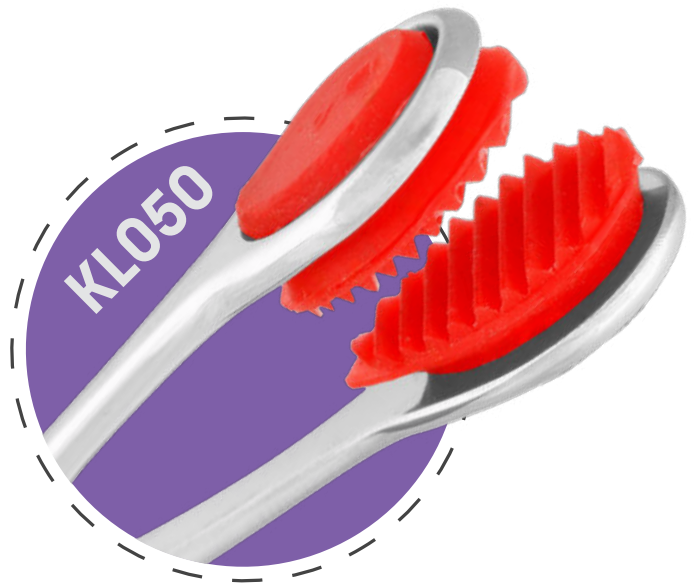

KL051
90mm
BACKHAUS

KL052
110 mm
BACKHAUS

KL053
135 mm
BACKHAUS





KL054
200 mm
GROSS



KL047
200 mm
GROSS



KL053
85 mm
SCHAEDEL



KL054
85 mm
JONES

PENSETLER TWEEZERS

Cerrahi pensetler, dikiş atma veya diğer cerrahi prosedürler sırasında yumuşak dokuyu tutan ve stabilize eden temel dişçilik aletleridir. Örneğin; Alveol kemiğinden bir dişin çıkarılmasını içeren diş çekimi prosedürü.

Surgical tweezers are essential dental instruments, which grip soft tissue and stabilize it during suturing or other surgical procedures. For example; Dental extraction procedure, which involves the removal of a tooth from the alveolar bone.



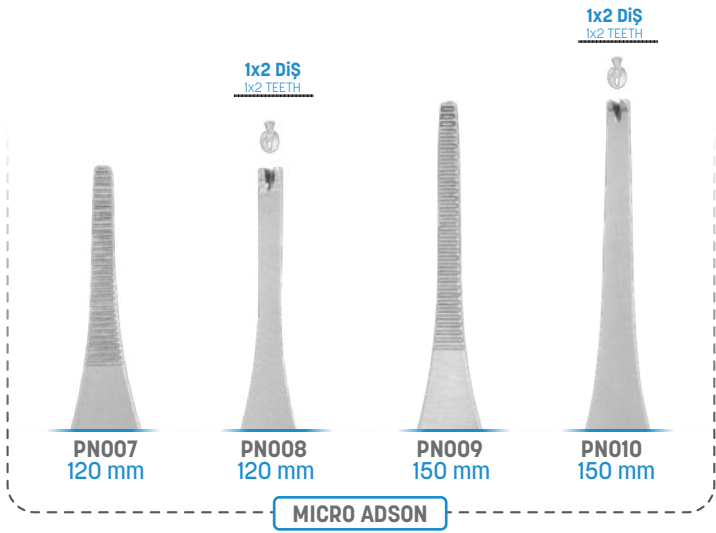
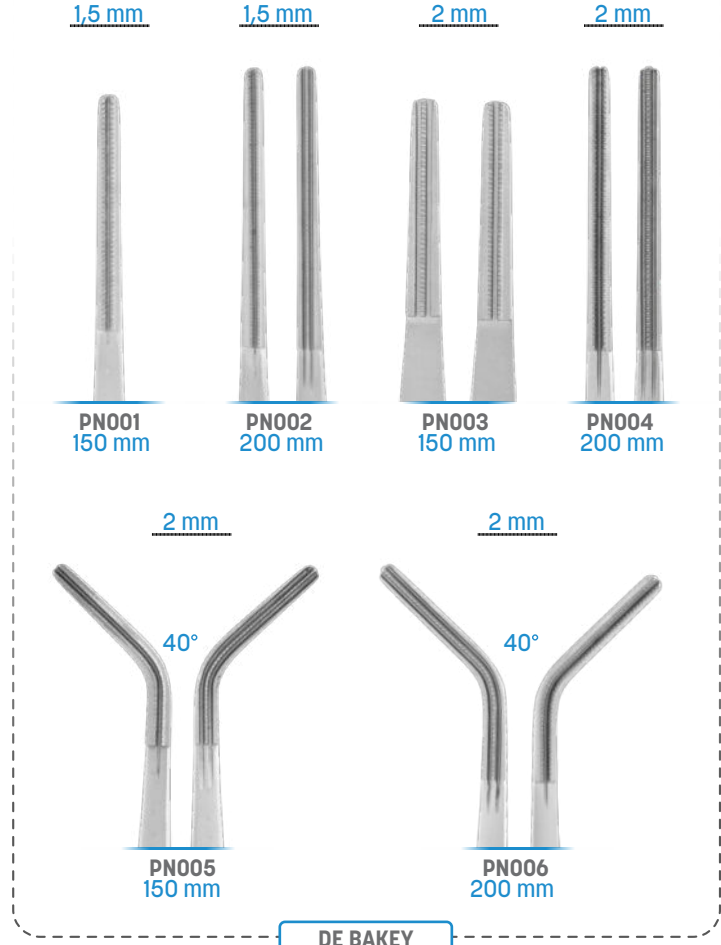
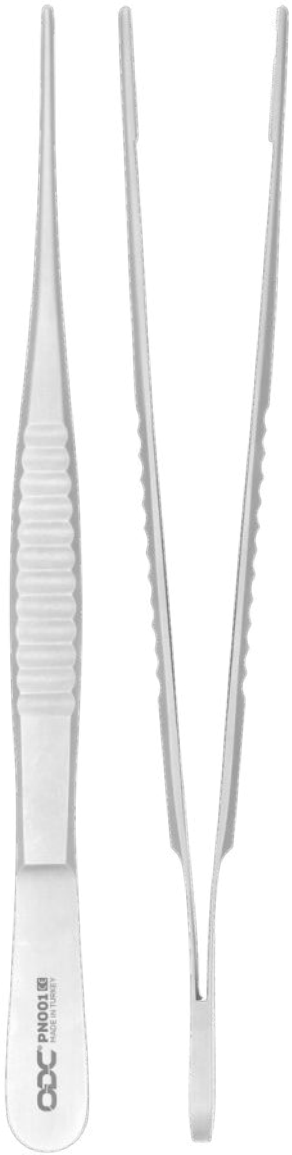

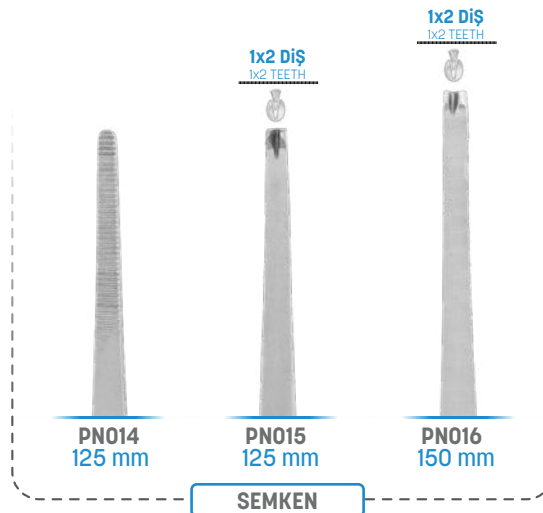
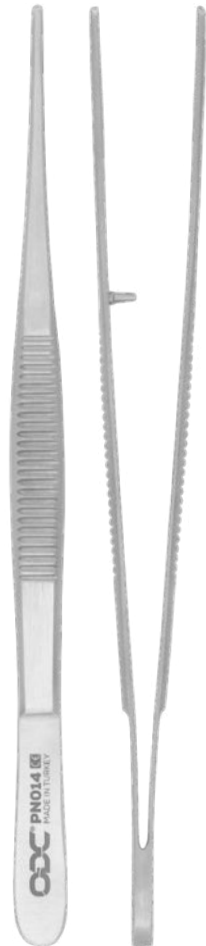
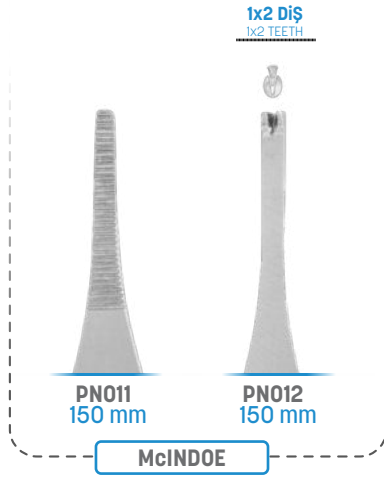
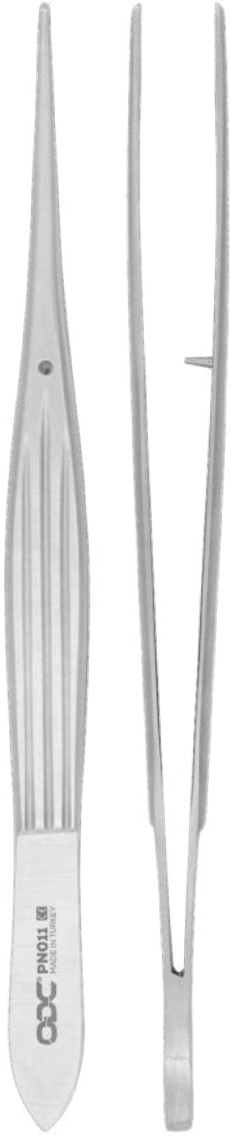

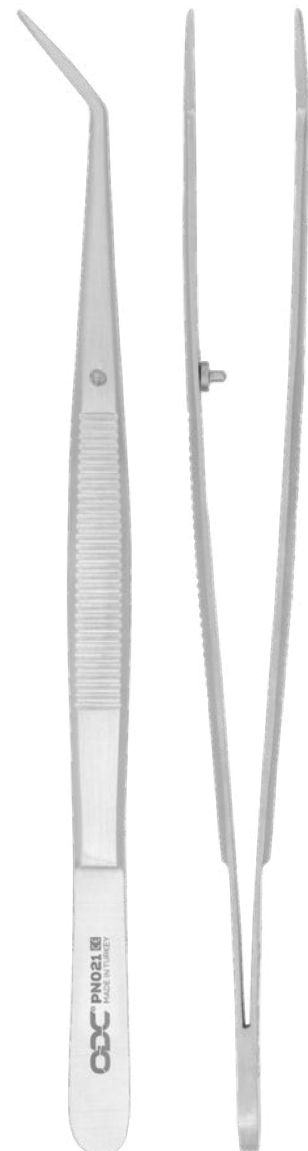
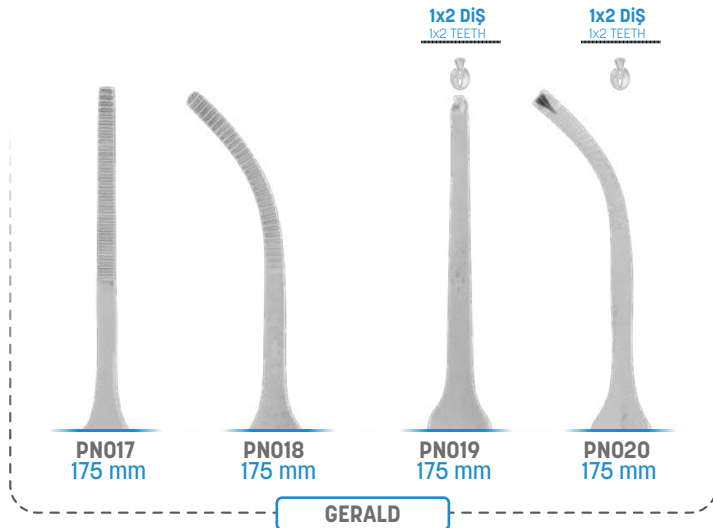
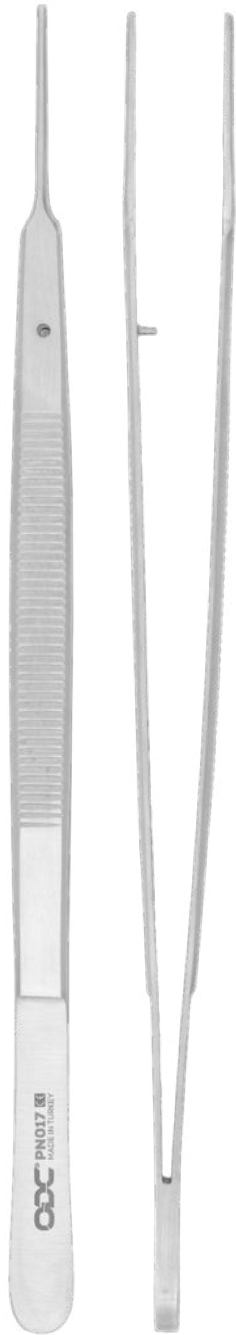

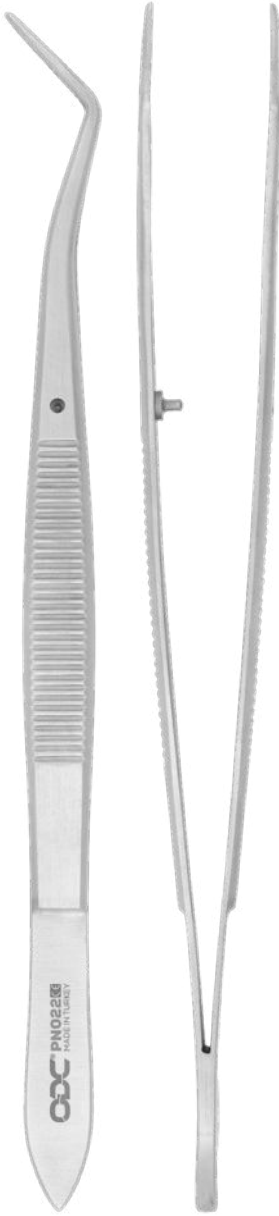

PN021
160 mm

MERIAM

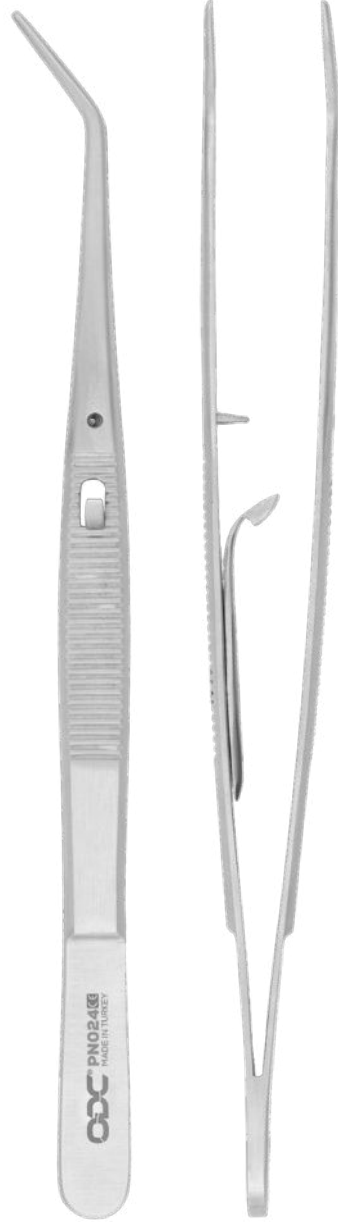

PN024
160 mm

COLLEGE-S



1x2 Diş
1x2 TEETH



PN025
120 mm



PN026
120 mm

ADSON

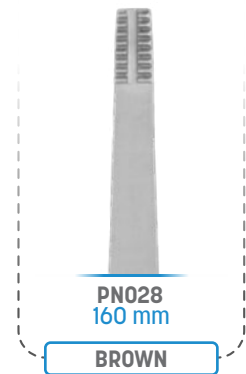
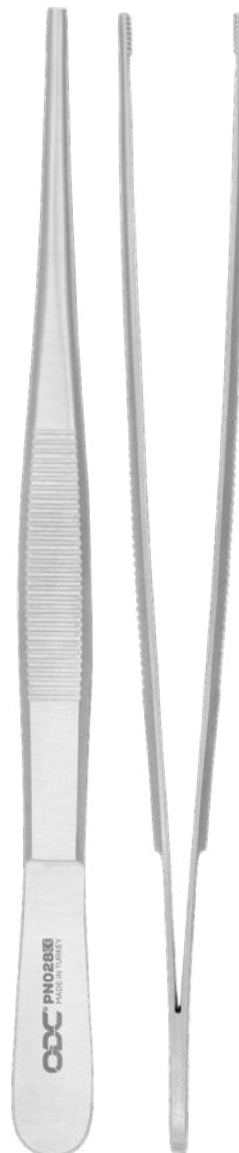
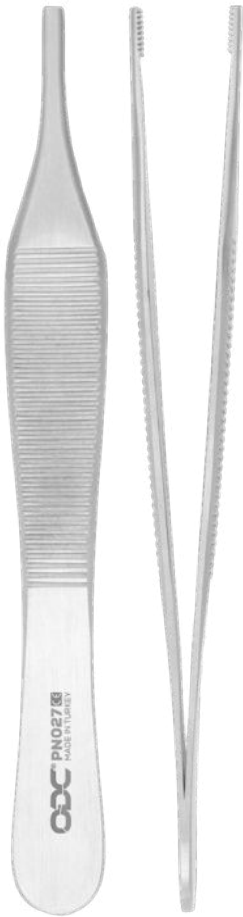

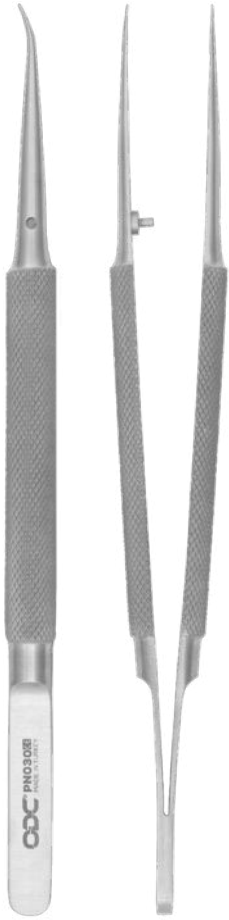

PN029
120 mm



PN030
120 mm



PN031
150 mm



PN032
150 mm



PN033
180 mm



PN034
180 mm

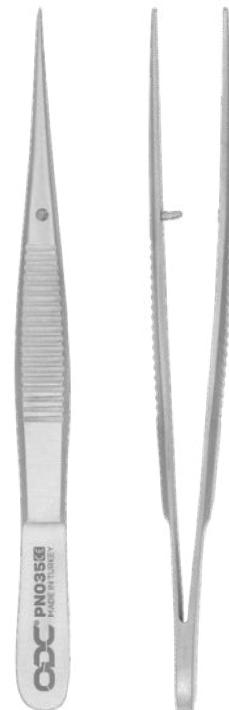

PN035
90 mm



PN037
105 mm



PN039
115 mm



PN041
130 mm



PN043
145 mm



PN036
90 mm



PN038
105 mm



PN040
115 mm



PN042
130 mm



PN044
145 mm

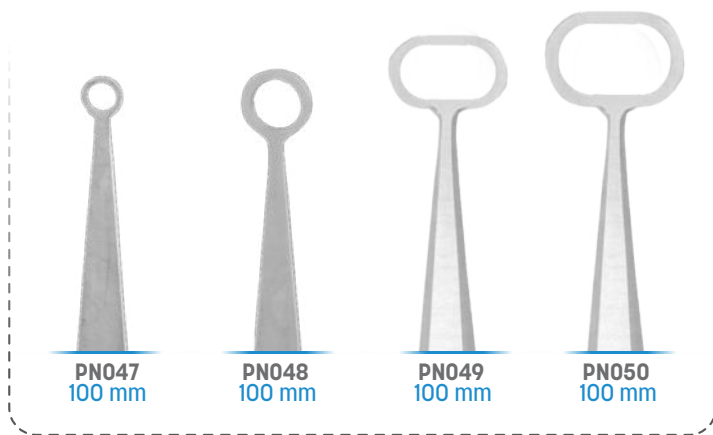
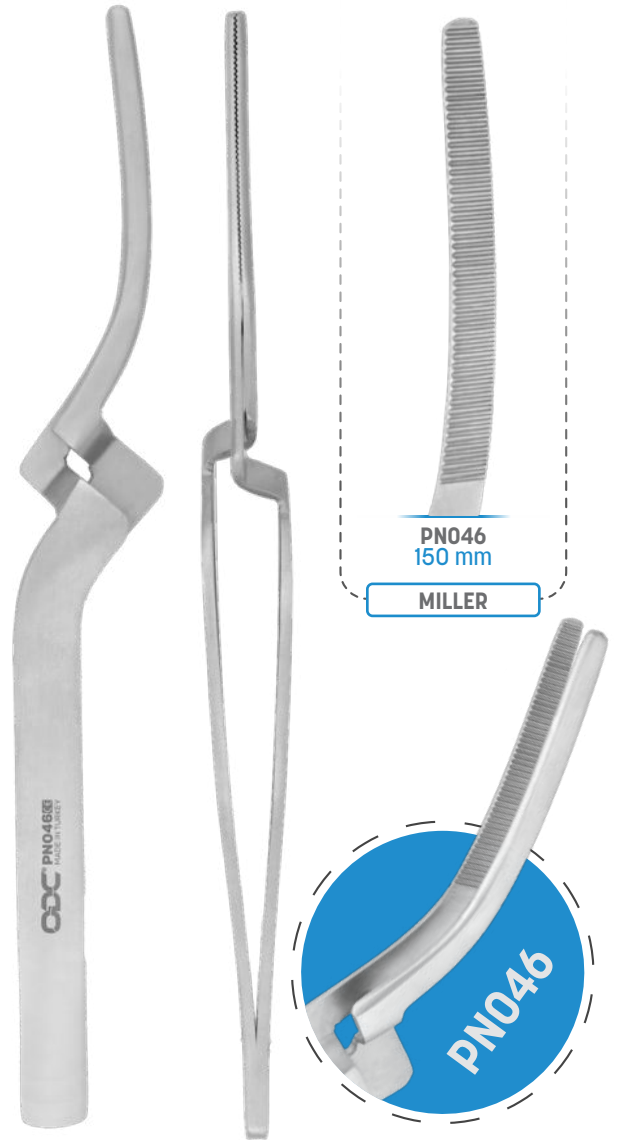
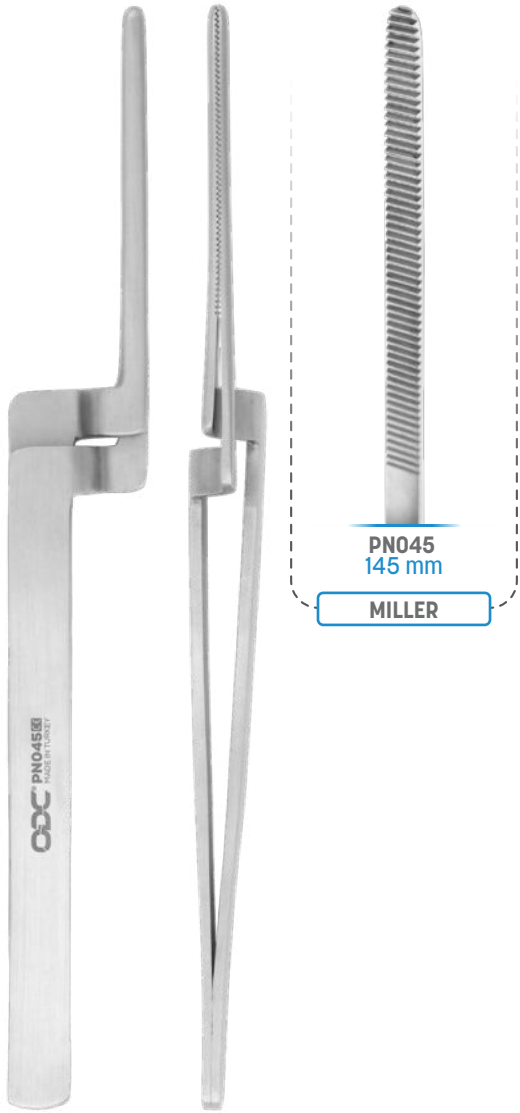

26 mm



PN051
90 mm

20 mm



PN052
85 mm

DESMARRES



PN051



PN053

PN053
150 mm

TASO

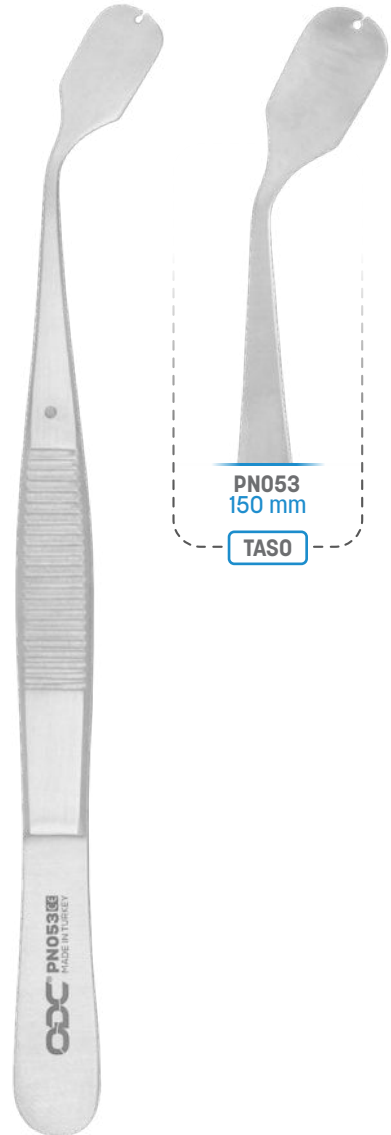

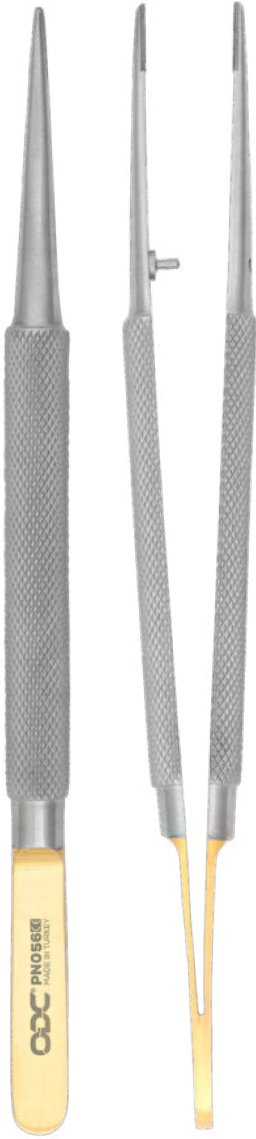

PN056
150 mm

PN058
180 mm

PN060
210 mm

PN062
230 mm

PN057
150 mm

PN059
180 mm

PN061
210 mm

PN063
230 mm

Dişsiz

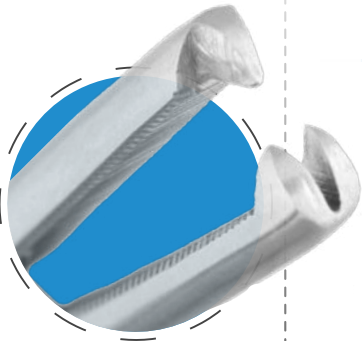

PN064
150 mm

PN066
180 mm

PN068
210 mm

PN070
230 mm

PN065
150 mm

PN067
180 mm

PN069
210 mm

PN071
230 mm

Dişli

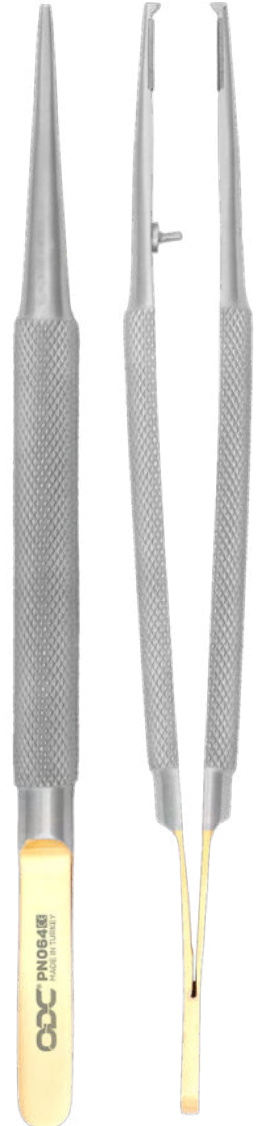

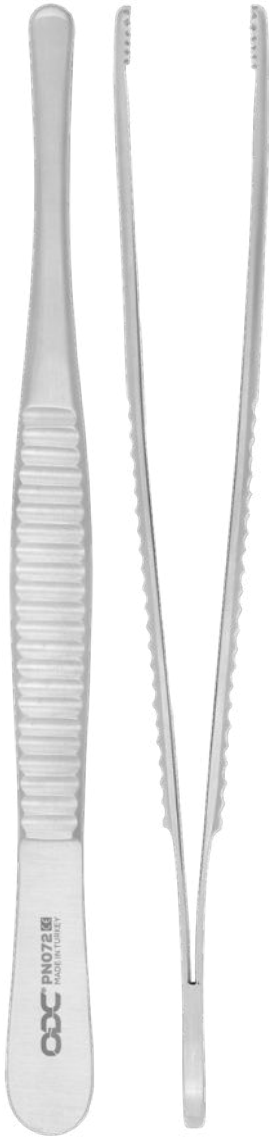

PN072
150 mm

PN073
150 mm

RUSSIAN

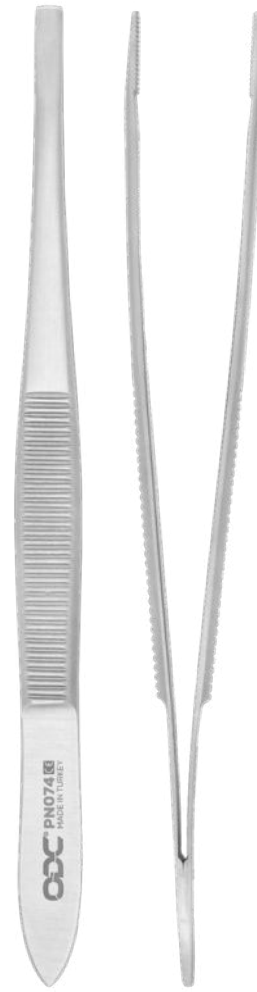

PN074
130 mm

PN075
150 mm

STILLE

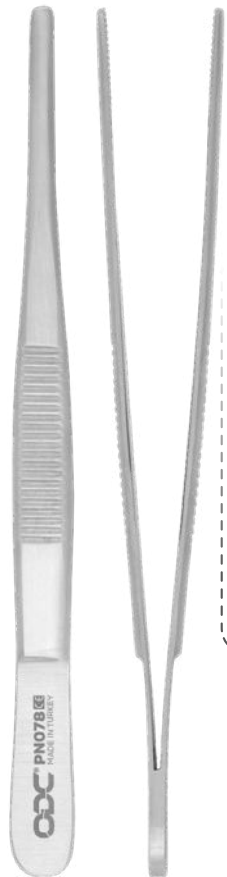

PN078
115 mm

PN079
130 mm

PN080
145 mm

STANDART

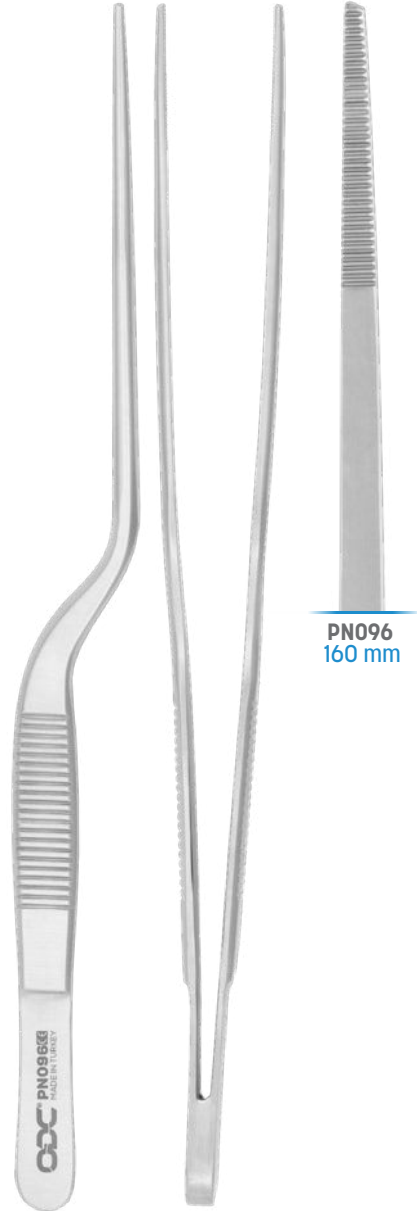
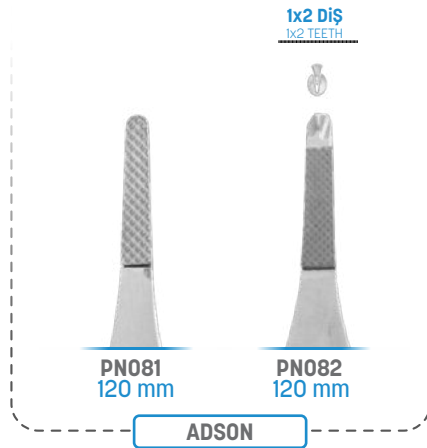

PN096
160 mm

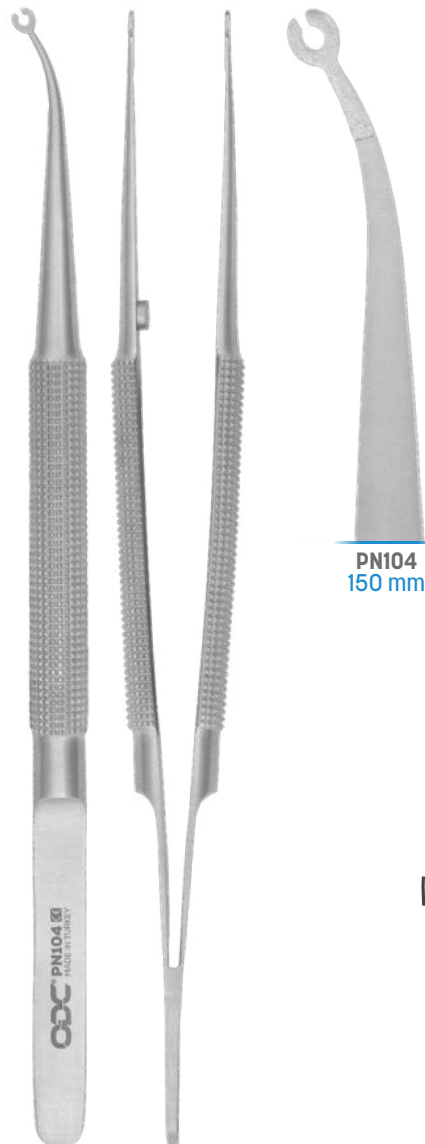

PN104
150 mm



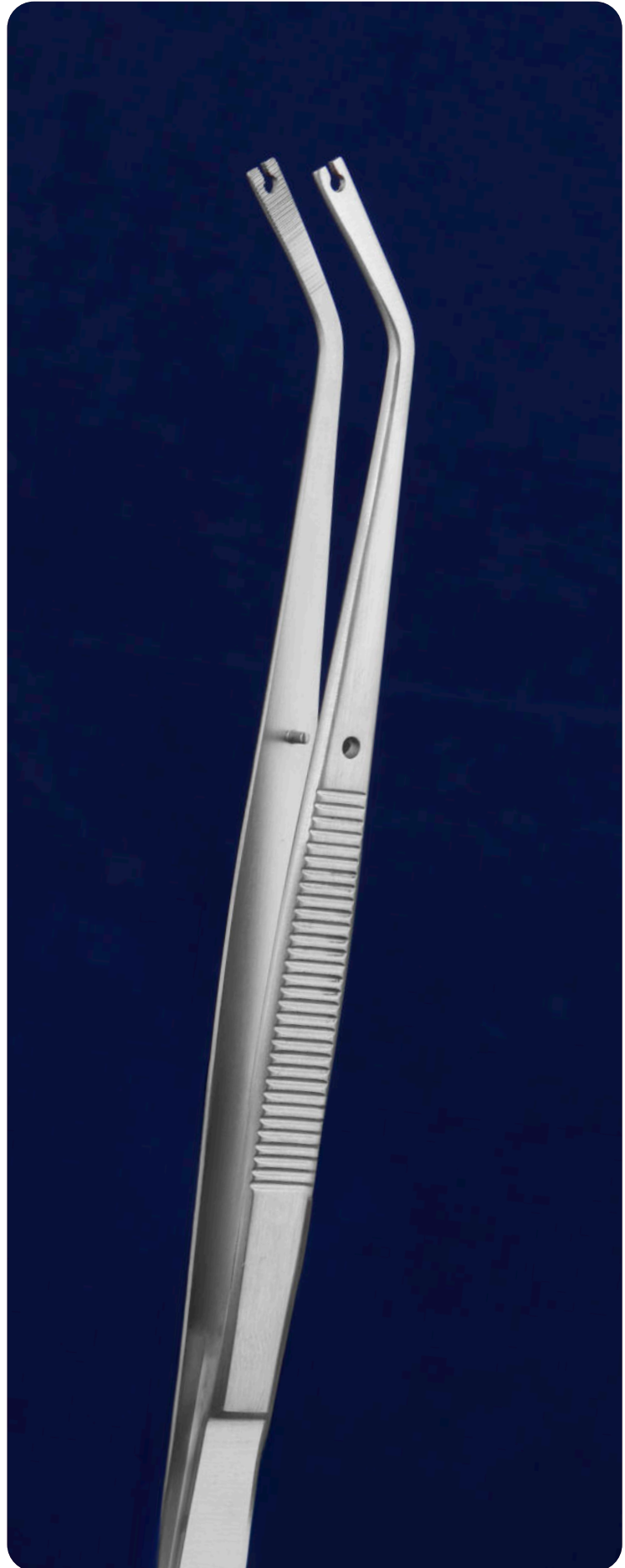



EKARTÖRLER RETRACTORS

Oral cerrahi prosedürler sırasında görselleştirmeyi ve erişimi iyileştirmek ve onlara koruma sağlamak için ağız boşluğundaki yumuşak dokuların manuel olarak yer değiştirmesi için kullanılması amaçlanan elde tutulan bir dişçilik aletidir.

It is a hand-held dental instrument intended to be used for manual displacement of soft tissues in the oral cavity to improve visualization and access and provide protection to them during oral surgical procedures.

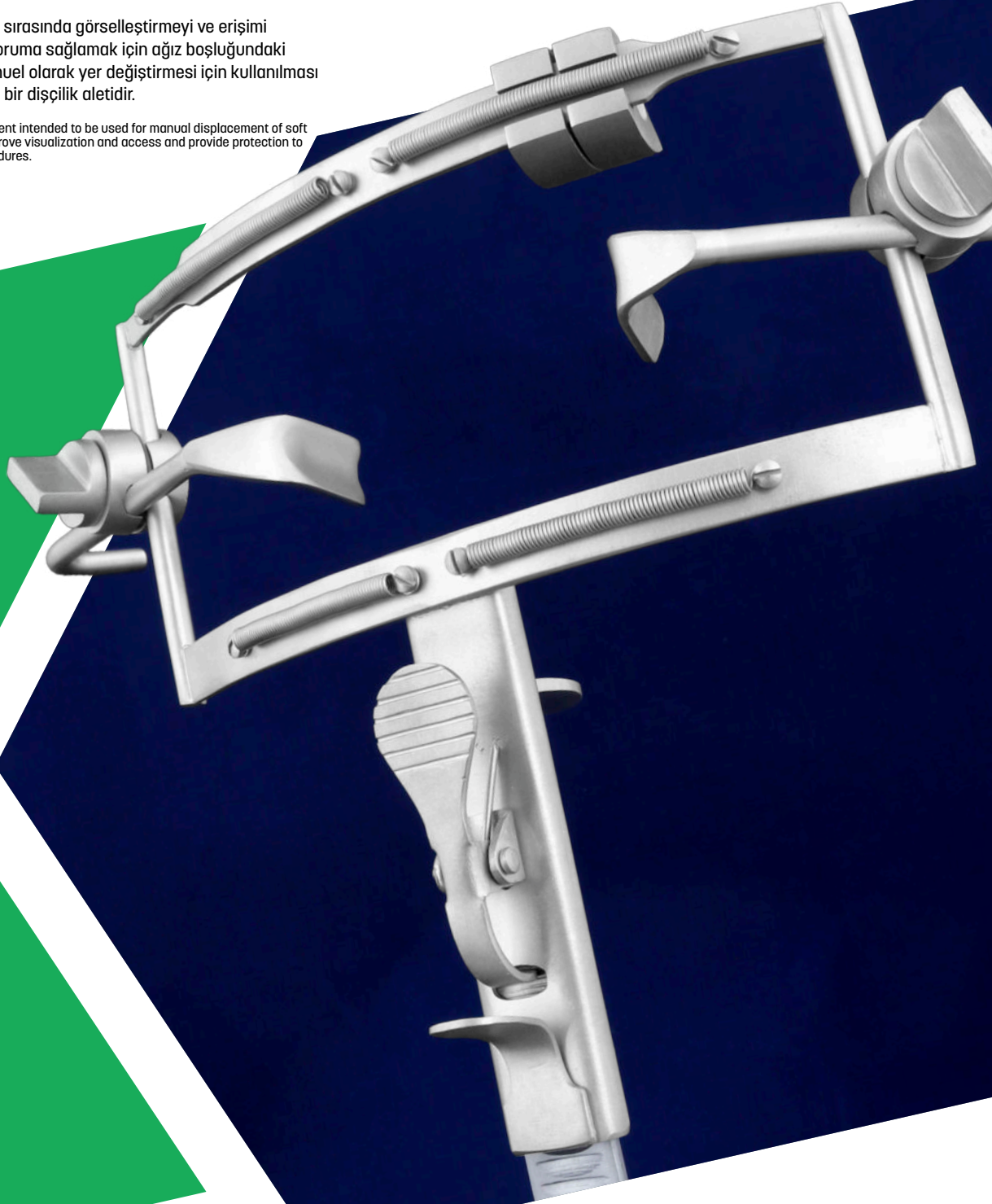

ERSOY
DENTAL

ODC
CERRAHI ALETLER

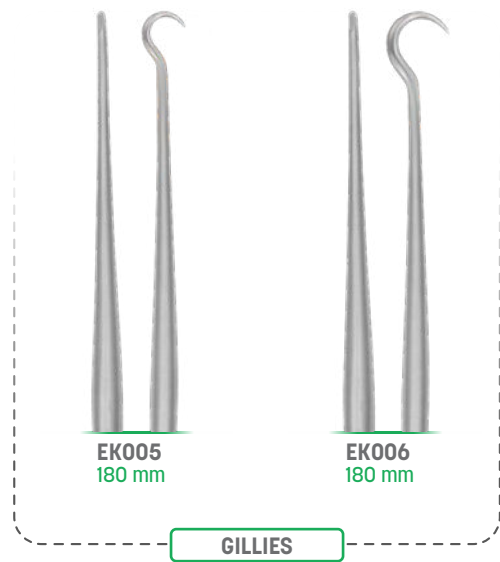
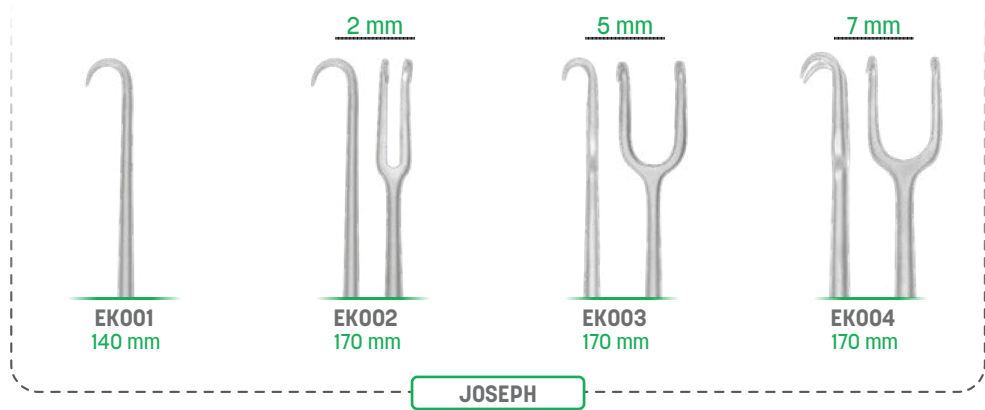

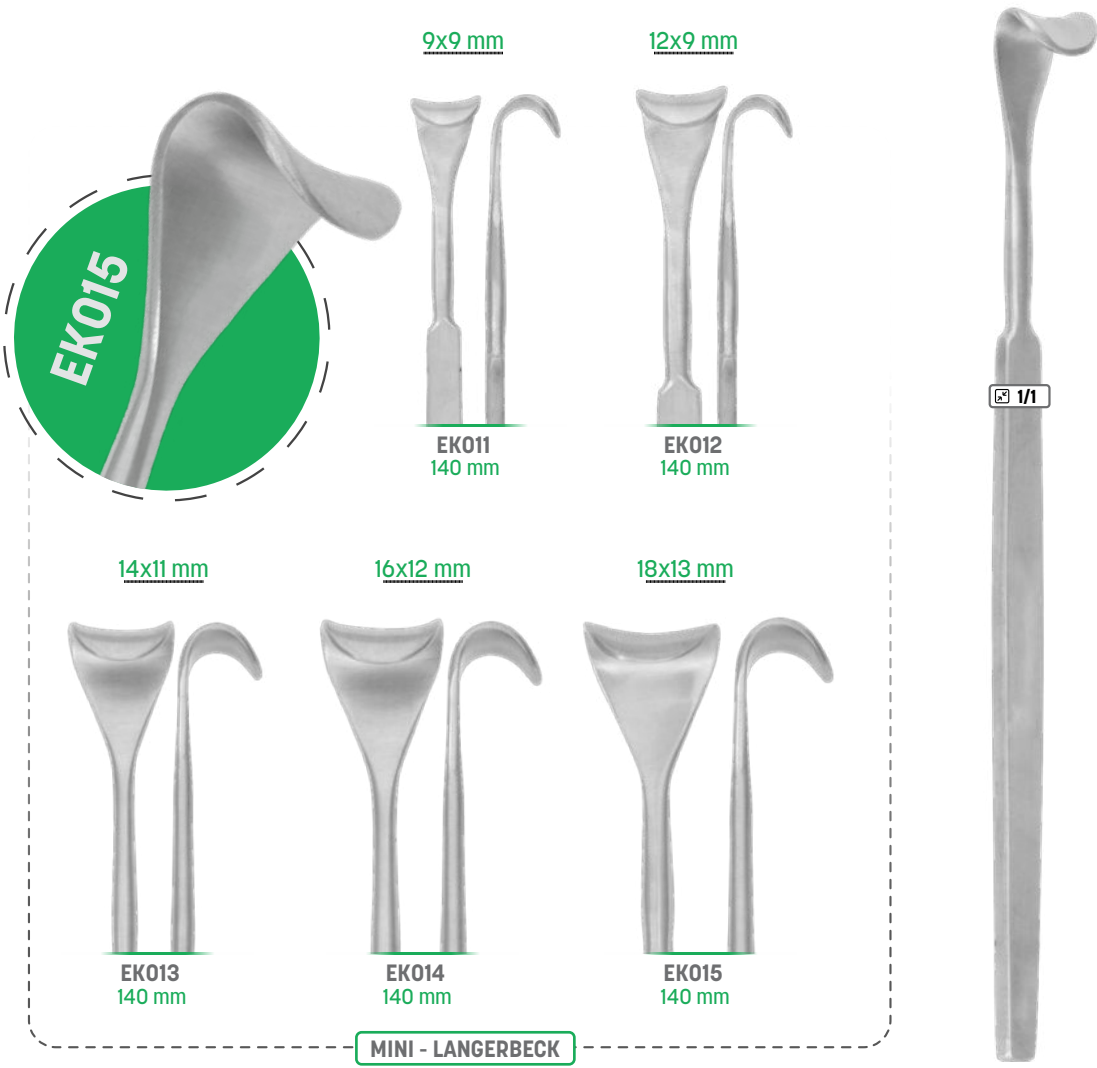
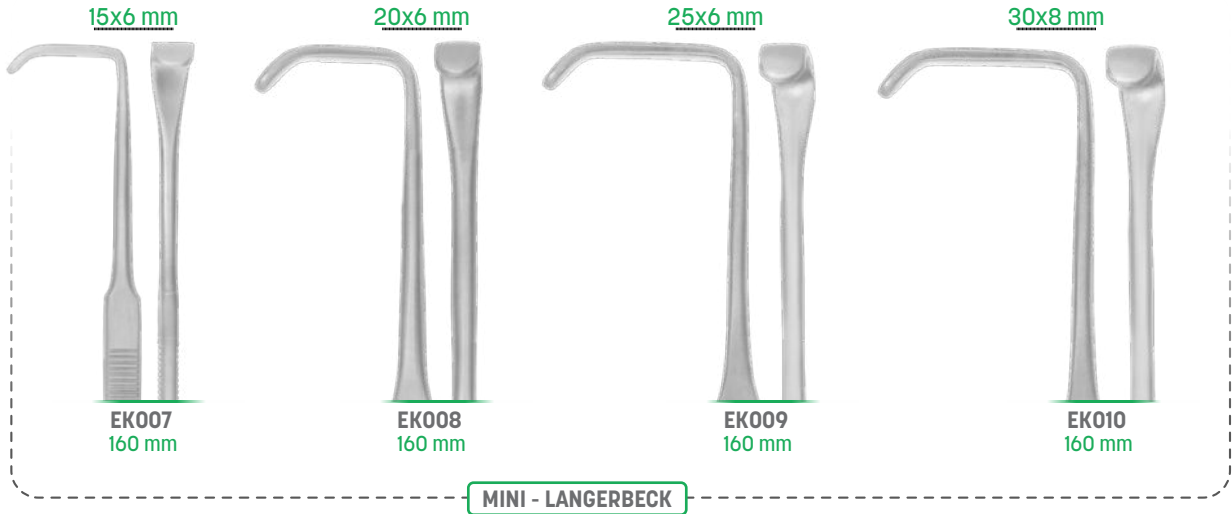



12x20 mm



EK016
205 mm

15x20 mm



EK017
205 mm

KOCHER



EK018
155 mm
Sivri Sharp



EK019
155 mm
Sean - Miller





EK020
165 mm



EK021
165 mm



EK022
165 mm



EK023
165 mm



EK024
165 mm



EK025
165 mm



EK026
165 mm



EK027
165 mm





EK028
155 mm



EK029
155 mm



EK030
155 mm

FLEXIBLE SHARP

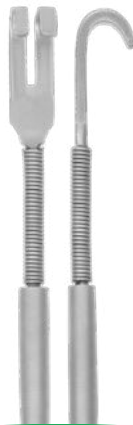

EK031
155 mm



EK032
155 mm



EK033
155 mm

FLEXIBLE BLUNT





EK034

EK034
210 mm
KIRSCH

EK035
210 mm
KIRSCH



EK036
220 mm
MIDDELDORPF



EK037
220 mm
MIDDELDORPF



EK038
220 mm
MIDDELDORPF





EK039
200 mm
CUSHING

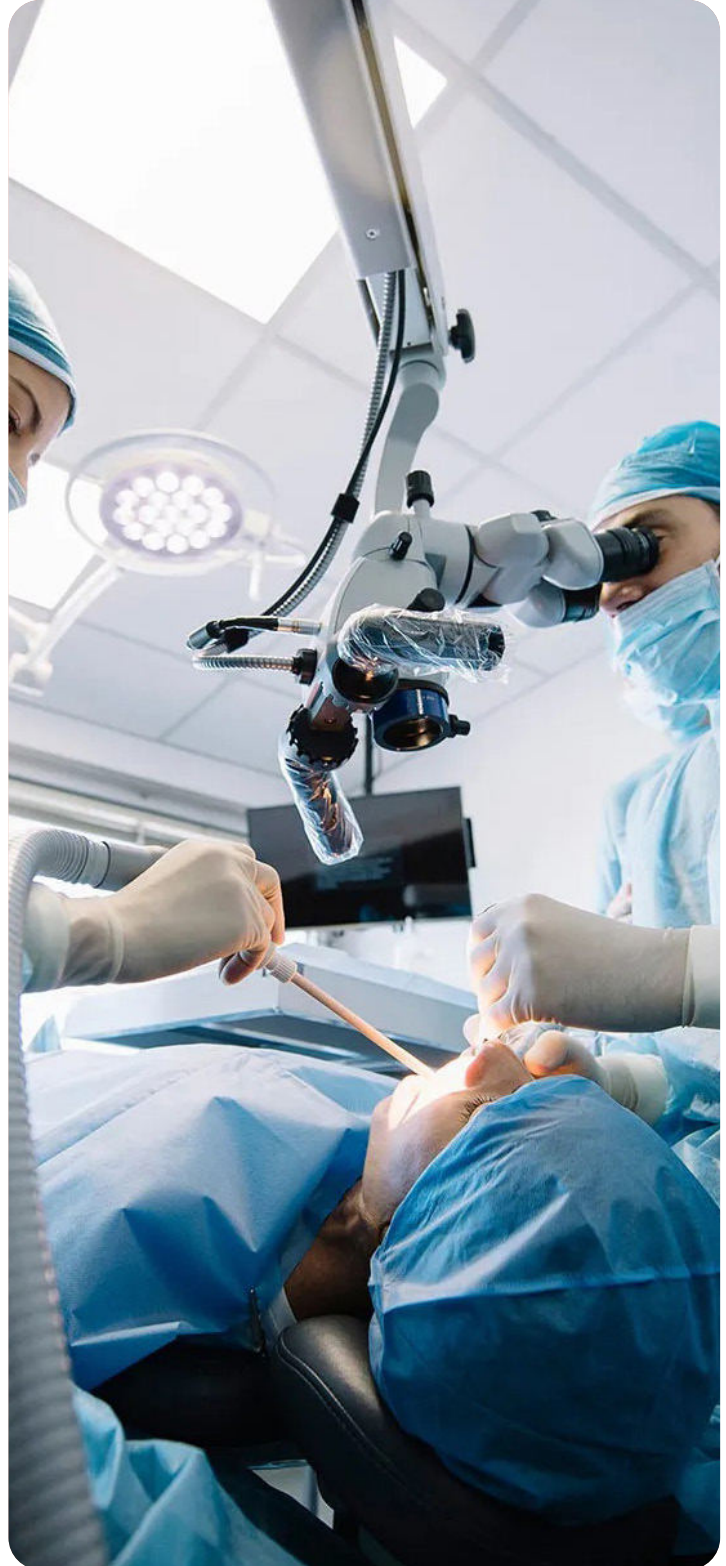

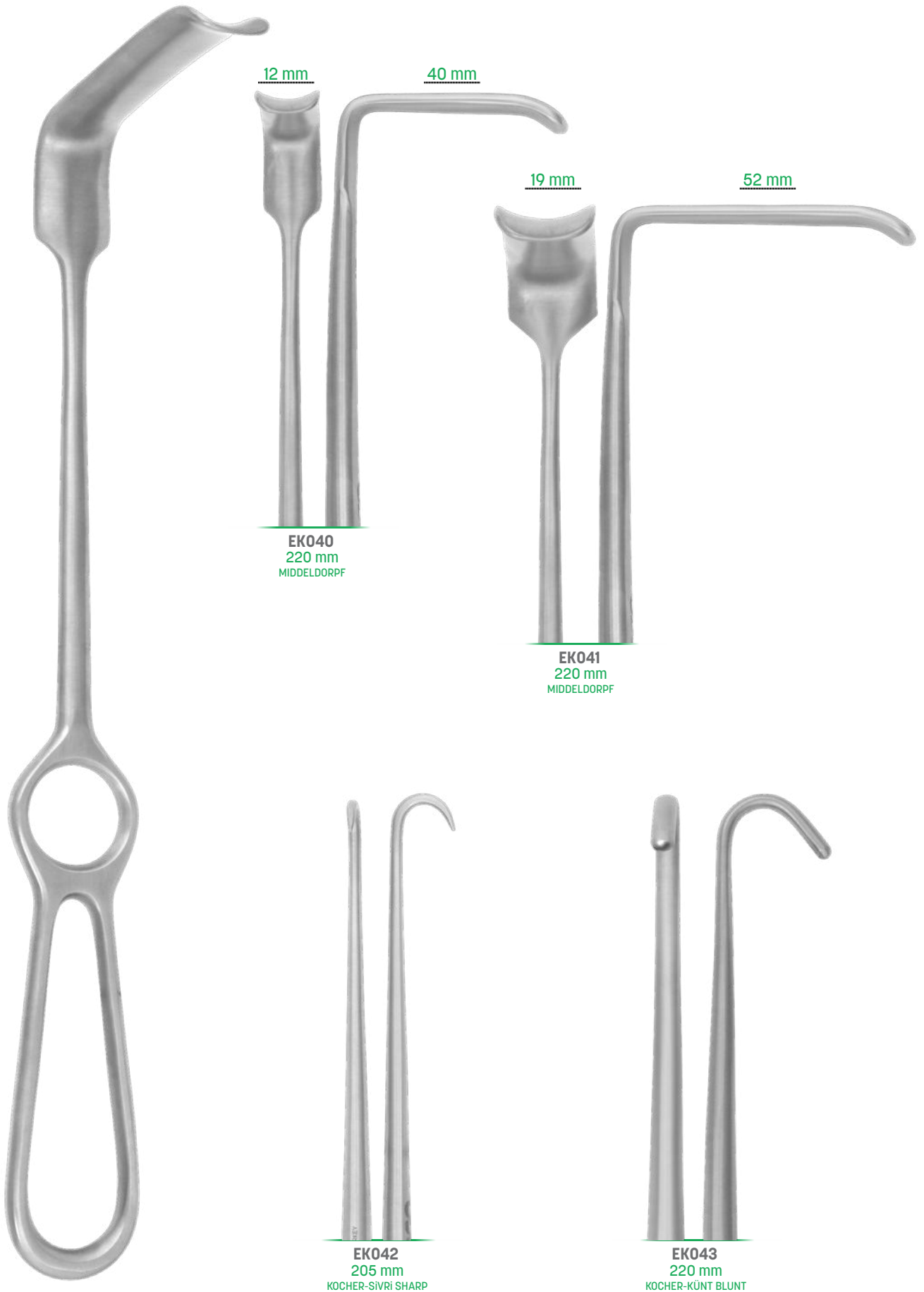





EK046
145 mm
TOBOLD



EK047
145 mm
HARTMANN





EK048
145 mm
OBMEGESER



Çocuk - For children
EK049
100 mm
1/1
MOLT



Yetişkin - For adults
EK050
120 mm
1/1
MOLT-DOYEN COLLIN

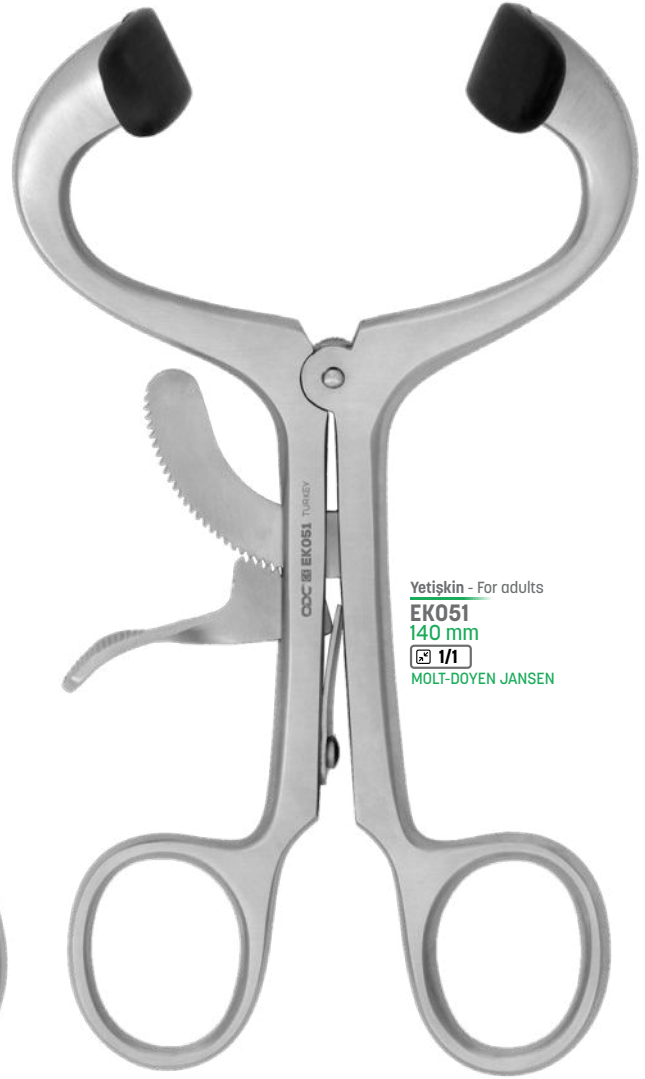

Yetişkin - For adults
EK051
140 mm
1/1
MOLT-DOYEN JANSEN



EK054
215 mm
1/1
OBWEGESER



EK052

EK053

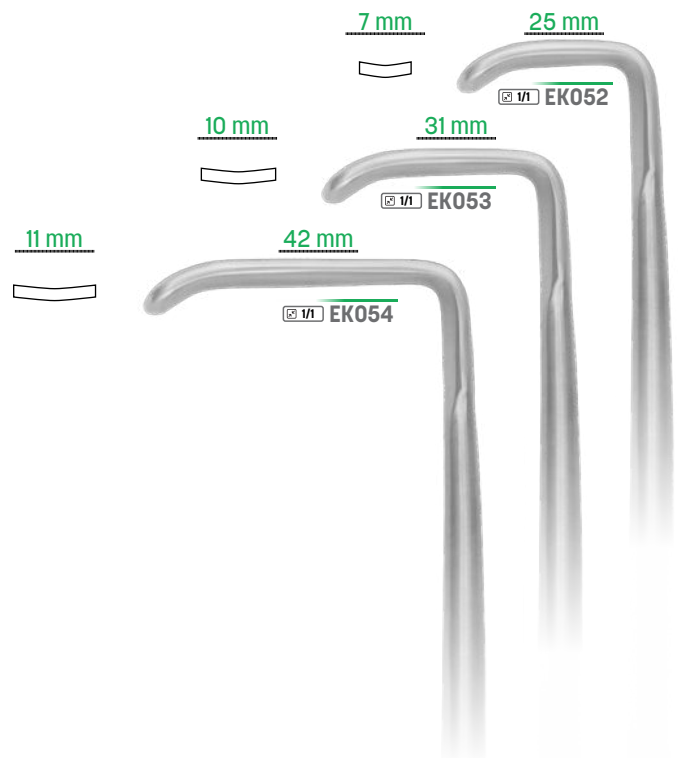

10 mm

31 mm

11 mm

42 mm

EK054

12 mm

55 mm

EK055

14 mm

70 mm

EK056

16 mm

80 mm

EK057



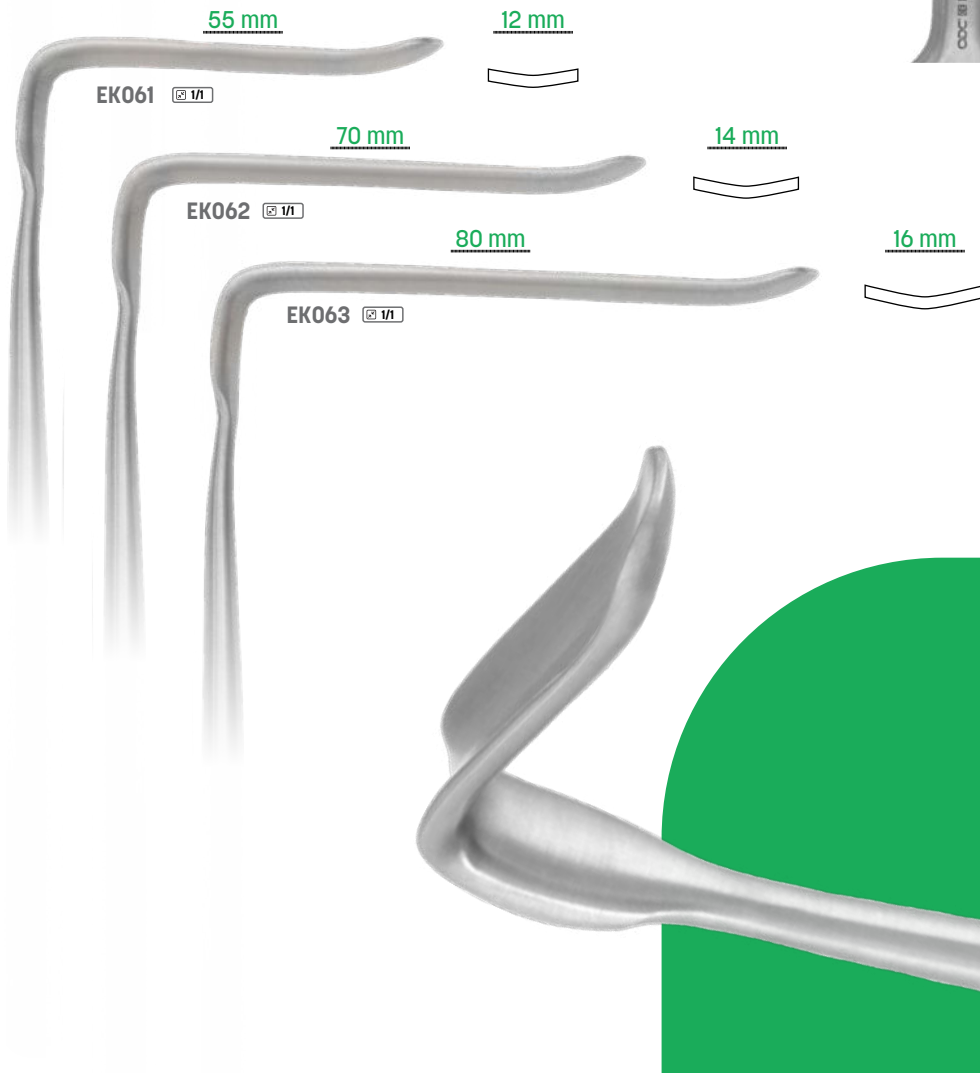
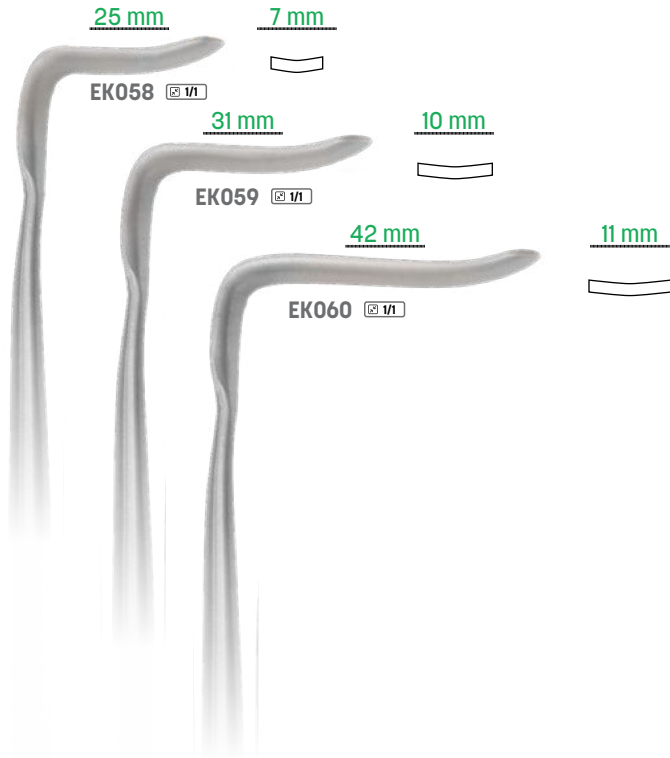

EK060
215 mm

OBWEGESER





EK064
125 mm
FARABEUF



EK065
150 mm
FARABEUF





EK069
165 mm
1/1
ROUX

EK068
157 mm
1/1
ROUX

EK067
140 mm
1/1
ROUX





42 mm



10 mm

EK070
220 mm
OBWEGESER

70 mm



11 mm

EK071
220 mm
OBWEGESER





EK072
200x12 mm
1/1
BÜKÜLEBİLİR
MALLEABLE

EK073
200x17 mm
1/1
BÜKÜLEBİLİR
MALLEABLE

EK074
250x25 mm
1/1
BÜKÜLEBİLİR
MALLEABLE



EK075
100x95 mm
1/1
ORİNGER

EK076
115x105 mm
1/1
ORİNGER

EK077
115x110 mm
1/1
ORİNGER

EK078
250x25 mm
1/1
ORİNGER



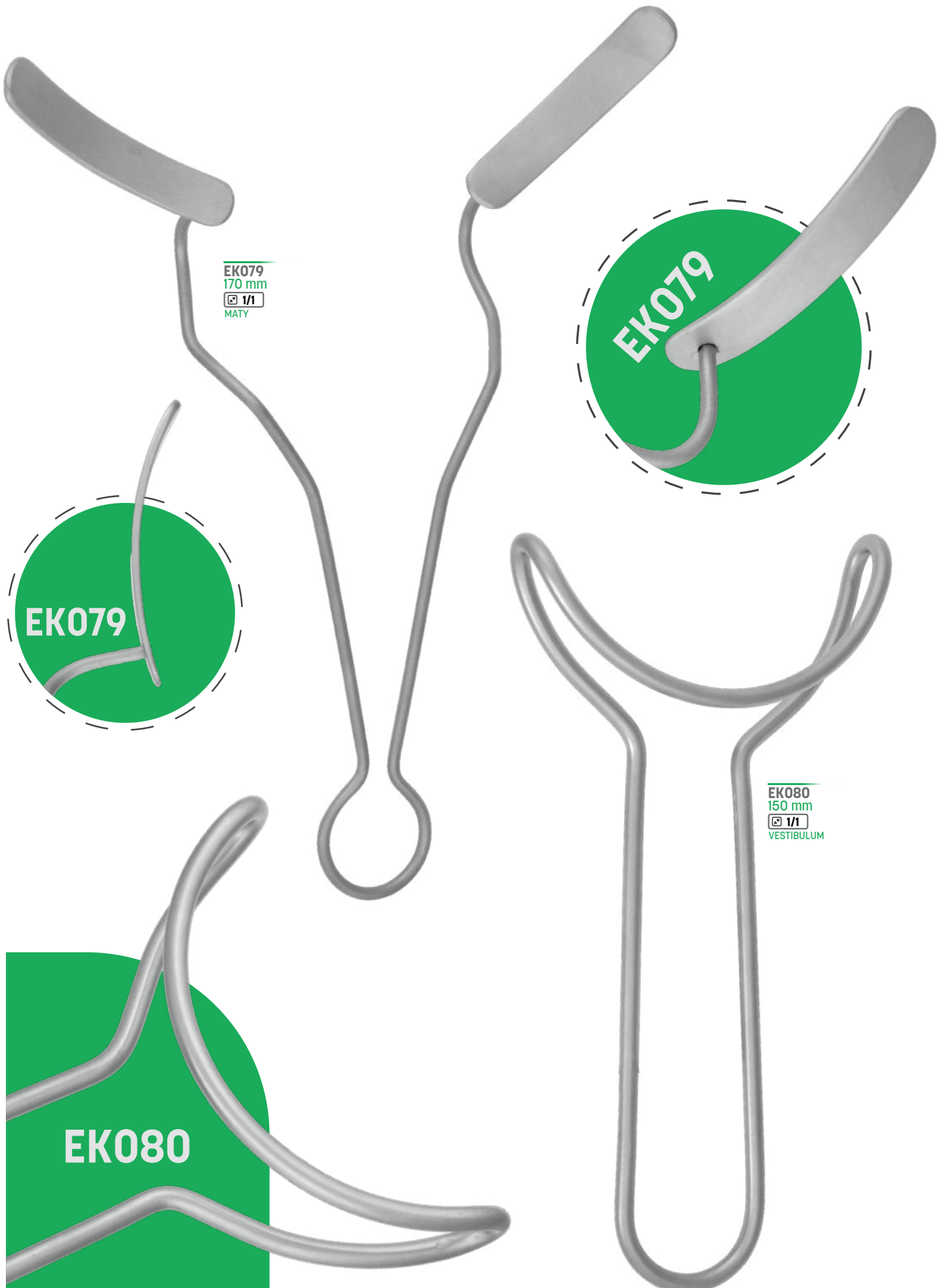

EK079
170 mm
1/1
MATY

EK079

EK079

EK080

EK080
150 mm
1/1
VESTIBULUM

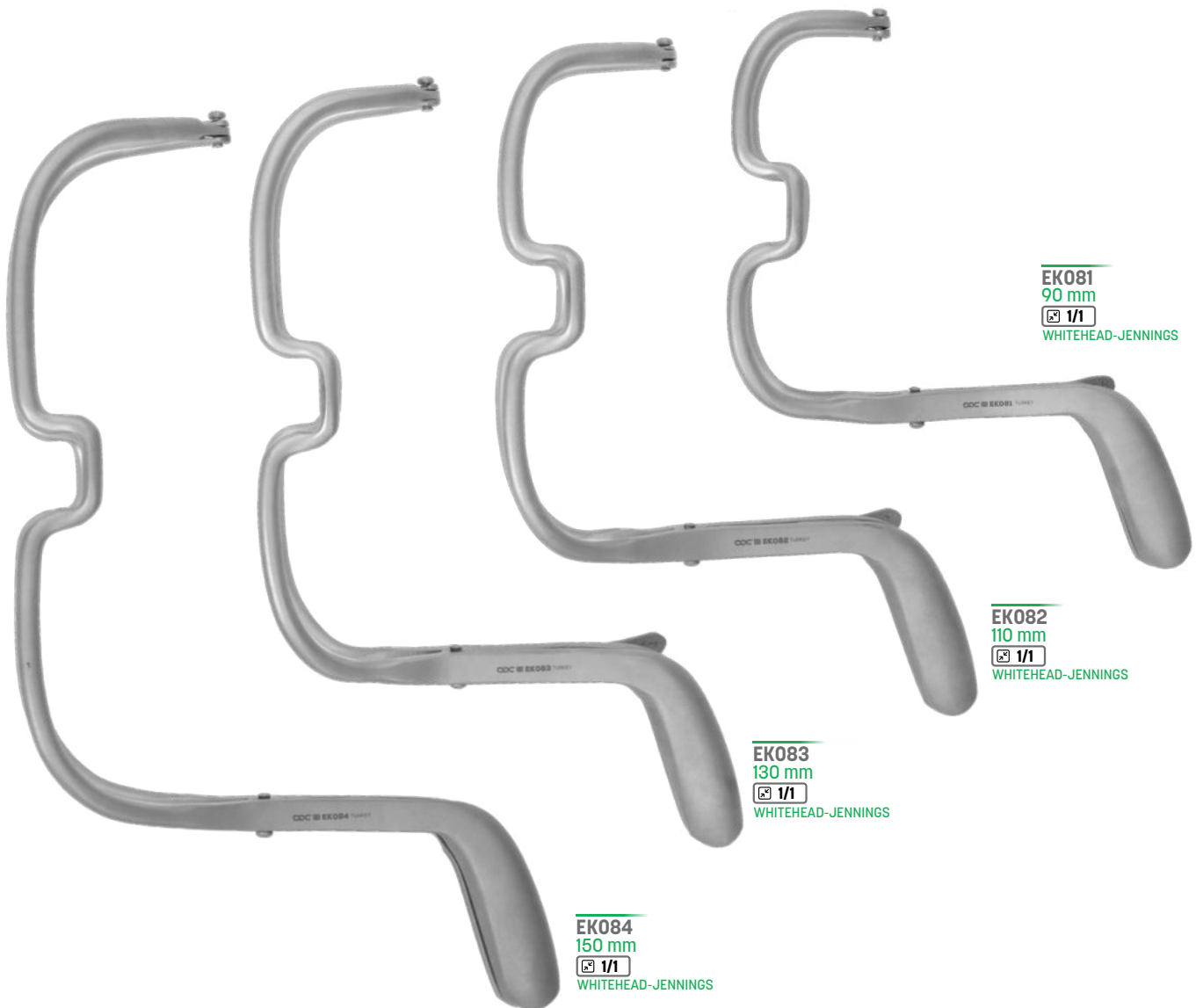
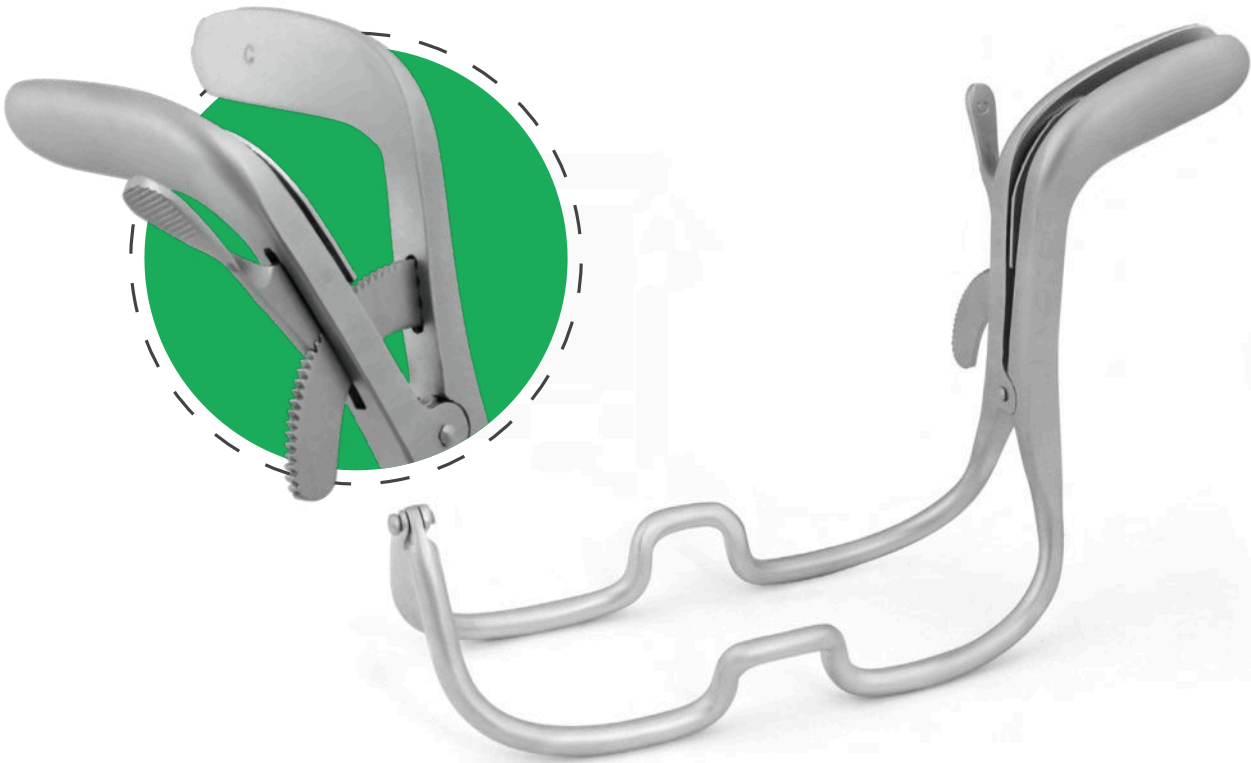

EK081
90 mm
1/1
WHITEHEAD-JENNINGS

EK082
110 mm
1/1
WHITEHEAD-JENNINGS

EK083
130 mm
1/1
WHITEHEAD-JENNINGS

EK084
150 mm
1/1
WHITEHEAD-JENNINGS

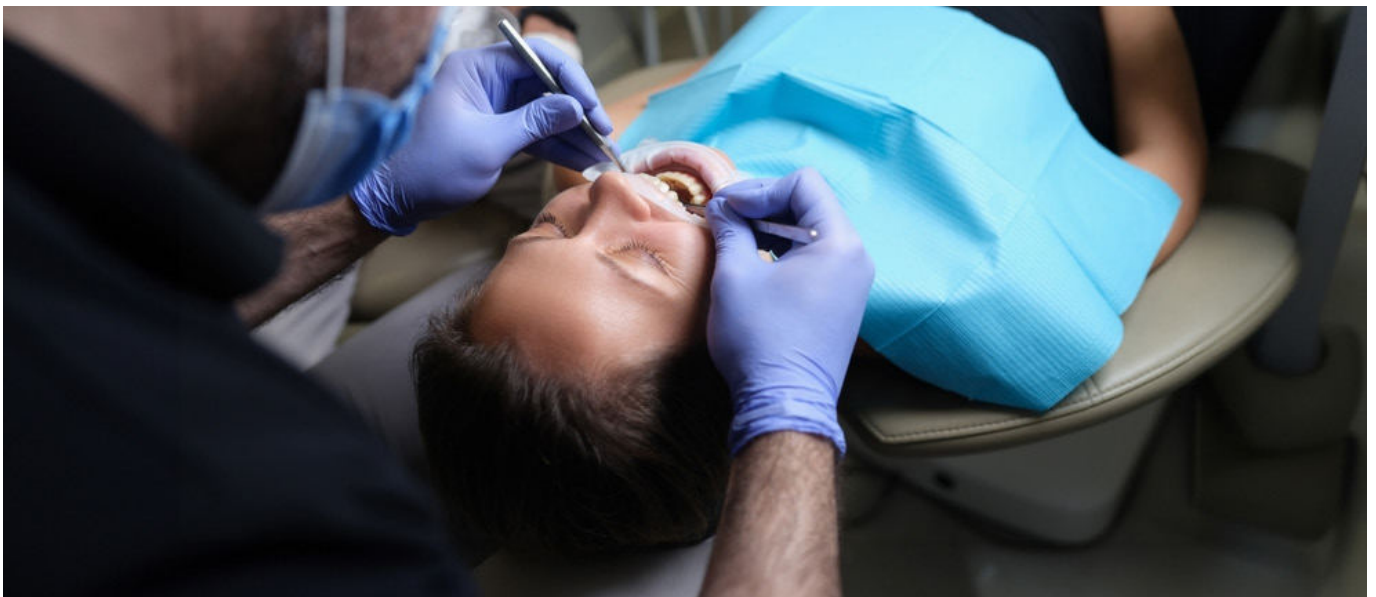

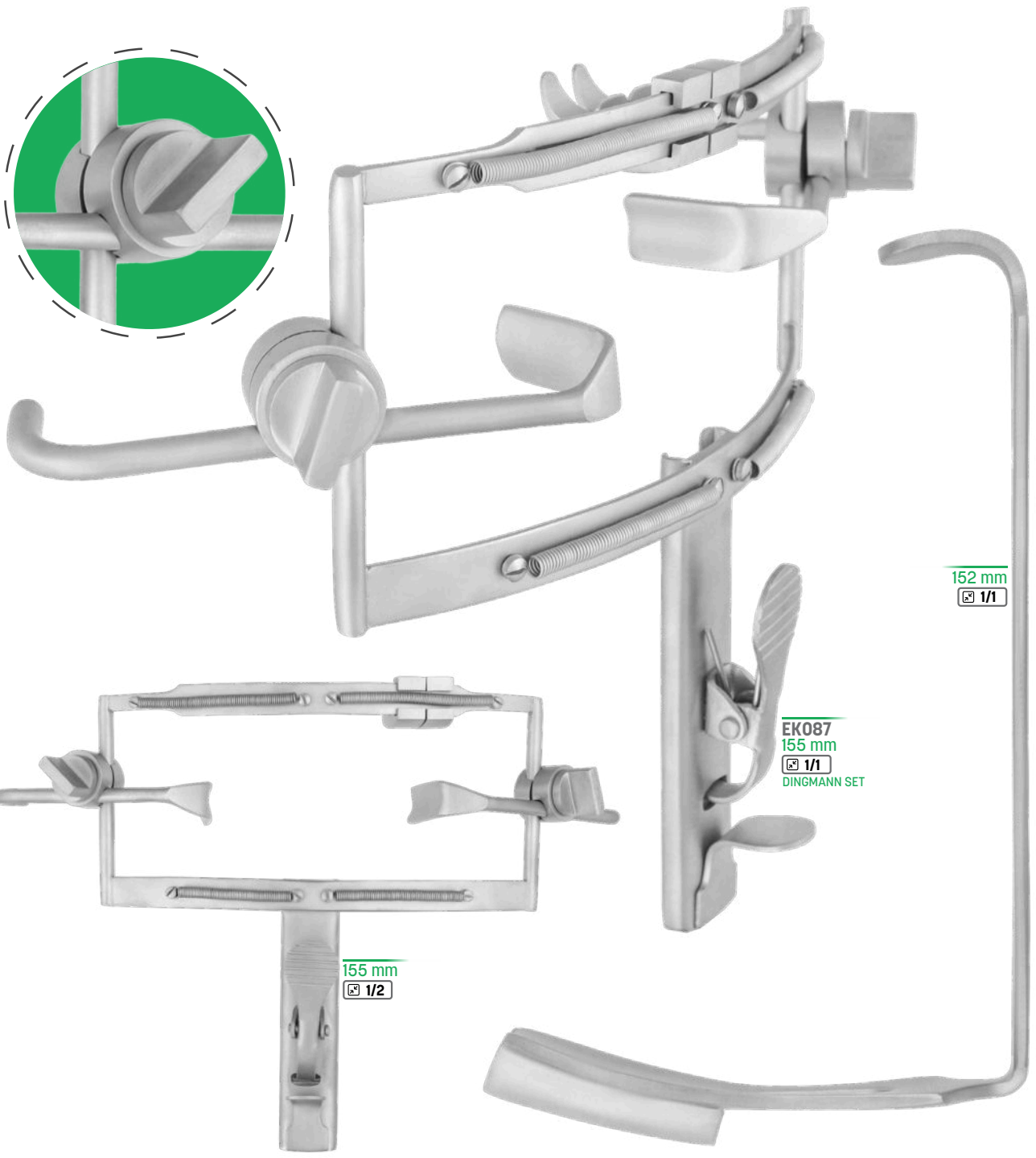
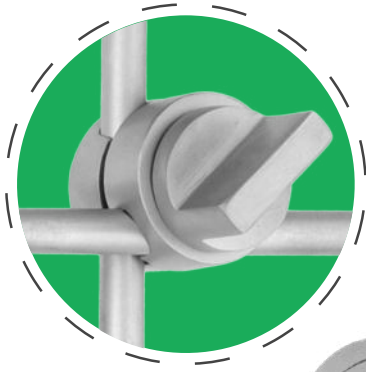

152 mm
☒ 1/1

EK087
155 mm
☒ 1/1
DINGMANN SET

155 mm
☒ 1/2



EK088
55x25 mm
☒ 1/1

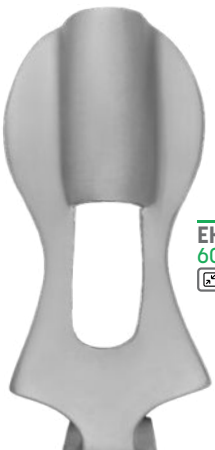

EK089
60x27 mm
☒ 1/1



EK090
70x30 mm
☒ 1/1



EK091
150 mm
1/1
ROUX



EK092
160 mm
1/1
ROUX



EK093
160 mm
1/1
ROUX



EK094
155 mm
1/1
CAWOOD-MINNESOTA



EK095
120 mm
1/1
STERNBERG

EK096
130 mm
1/1
STERNBERG

EK097
135 mm
1/1
STERNBERG

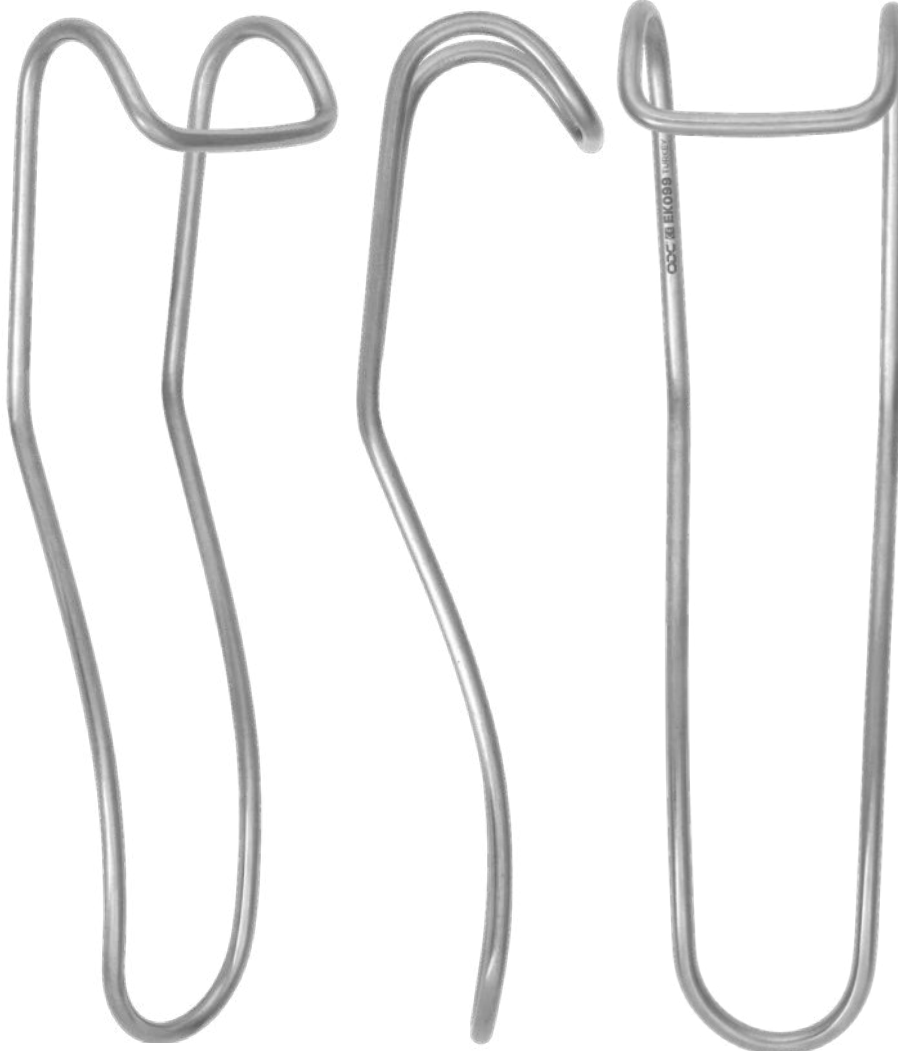
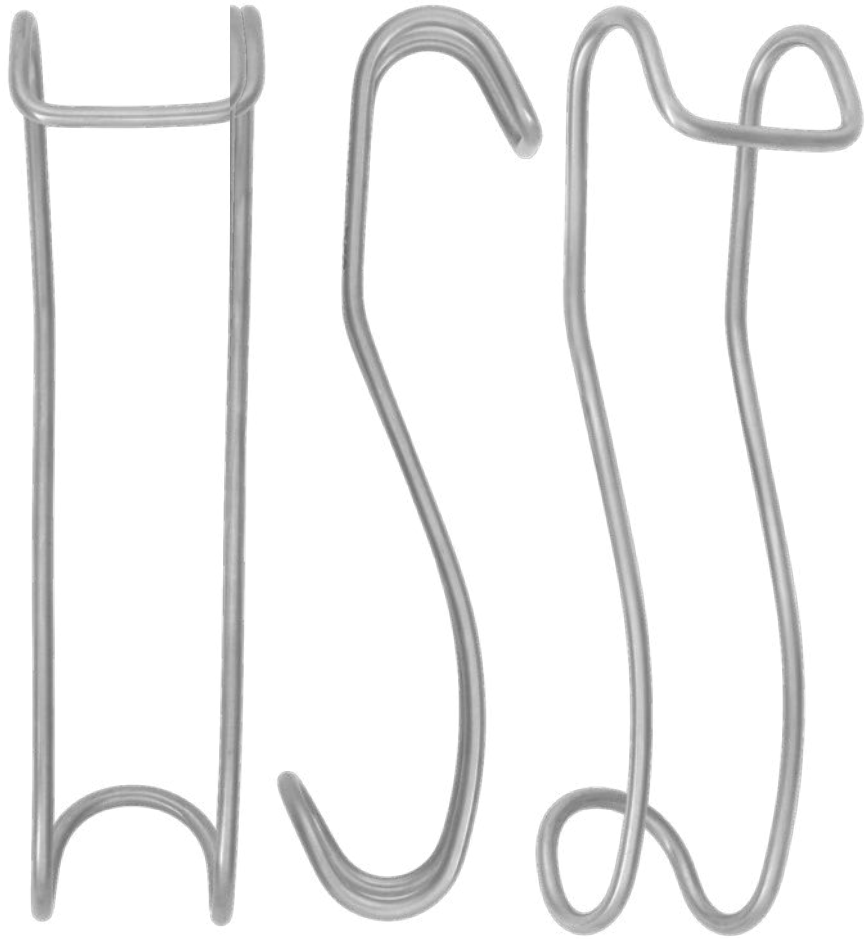

EK098
140 mm
1/1
STERNBERG

EK099
160 mm
1/1
STERNBERG

EK100
180 mm
1/1
STERNBERG



22 mm

EK101
130 mm
1/1
BISHOP



22x22 mm

EK102
225 mm
1/1
GREENE



EK103
205 mm
1/1
BLADE



EK104



EK104
220 mm
1/1
WASSMUND





EK105
190 mm
1/1
BRUENINGS



EK106
180 mm
1/1
BUCHWALD



EK107
165 mm
1/1
FRENZEL

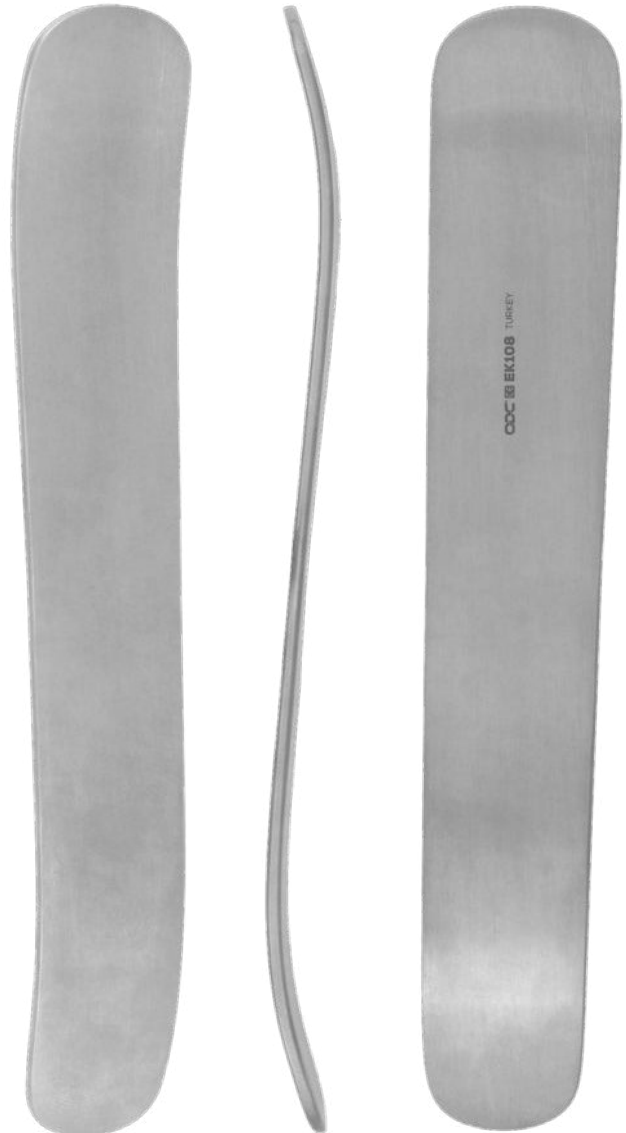

EK108
150 mm
1/1
KROENIG



EK112
210 mm
1/1
LANGENBECK

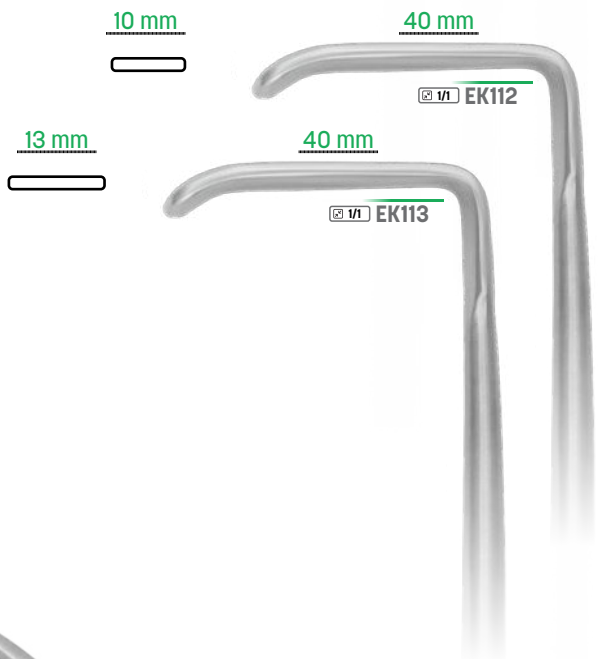
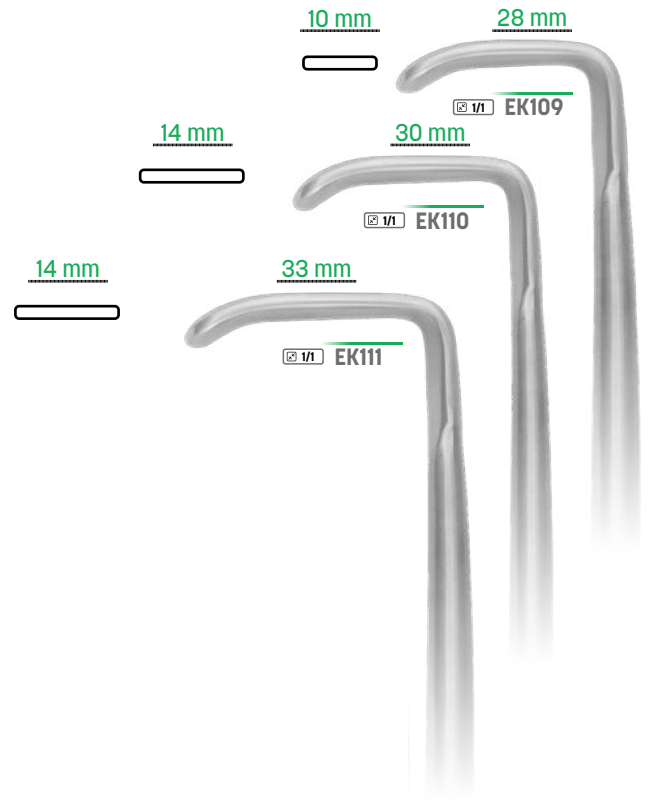

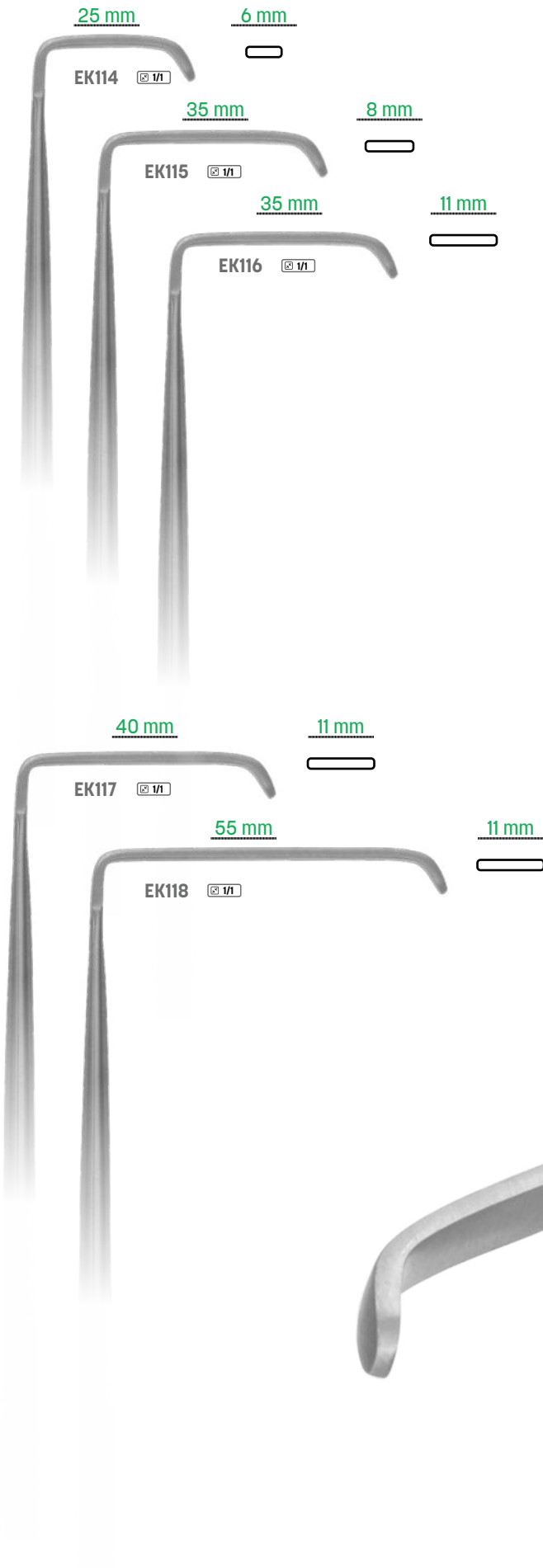

EK114
215 mm
1/1
KOCHER-LANGENBECK



KEMİK EĞE, KÜRET ve PENS

BONE FINA, CURETTE and RONGEURS

Kemik Eğeleri; Bir cerrahi prosedür sırasında kemiğin yüzeyini kazımak ve düzleştirmek için tasarlanmış, kaba ve/ince oluklar veya diş yüzeyleri olan, elde tutulan manuel cerrahi alettir.

Kemik Küreti, kemik dokusunu kazımak veya istenen kemik yüzeyinden birikintileri ve fibröz dokuyu çıkarmak için kullanılır.

Kemik Pensi, diş çekimi sonrası kemiğin alveol kretinin keskin kenarlarının çıkarılmasında kullanılır.

Bone Fina; It is hand-held manual surgical instrument with a surfaces of coarse and/ fine grooves or teeth designed to scrape and smooth the surface of bone during a surgical procedure.

Bone curette is used to scrape bone tissue or remove deposits and fibrous tissue from the desired bone surface.

Bone Rongeur is used in the removal of the sharp edges of the alveolar crest of the bone following tooth extraction.



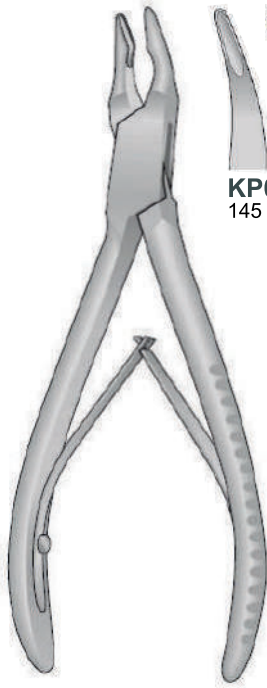

KP001
145 mm

KP002
140 mm

FRIEDMANN

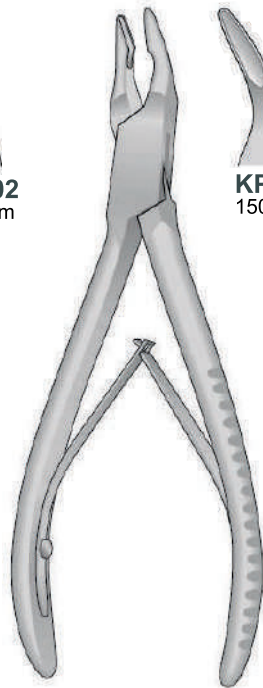

KP003
150 mm

KP004
150 mm

BLUMENTHAL

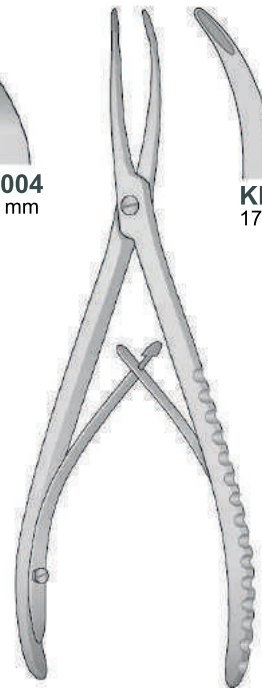

KP005
170 mm

KP006
170 mm

STELLBRINK

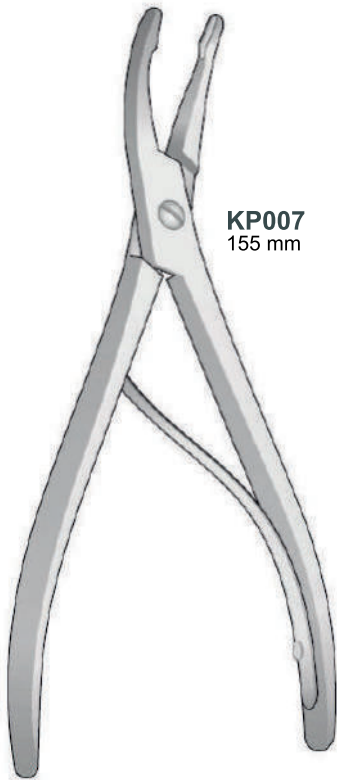

KP007
155 mm

LUER

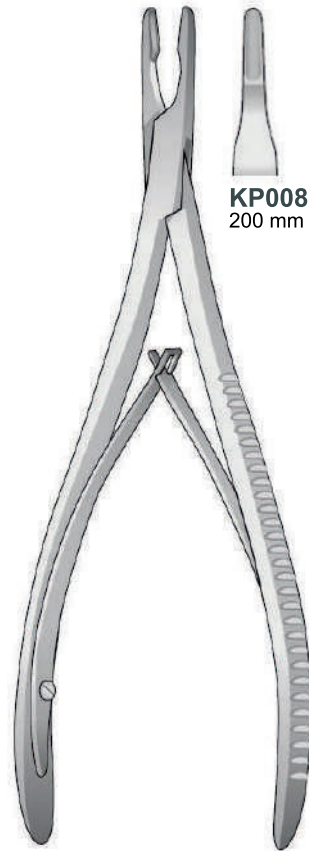

KP008
200 mm

KP009
200 mm

LEMPERT

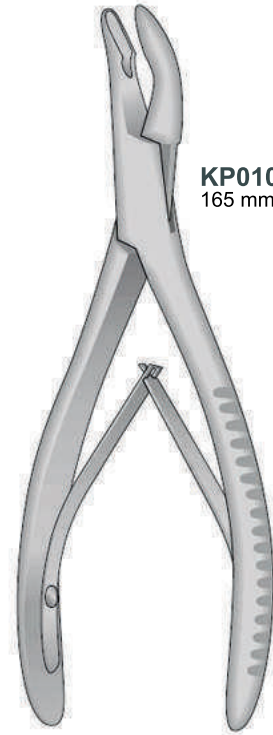

KP010
165 mm

MEAD

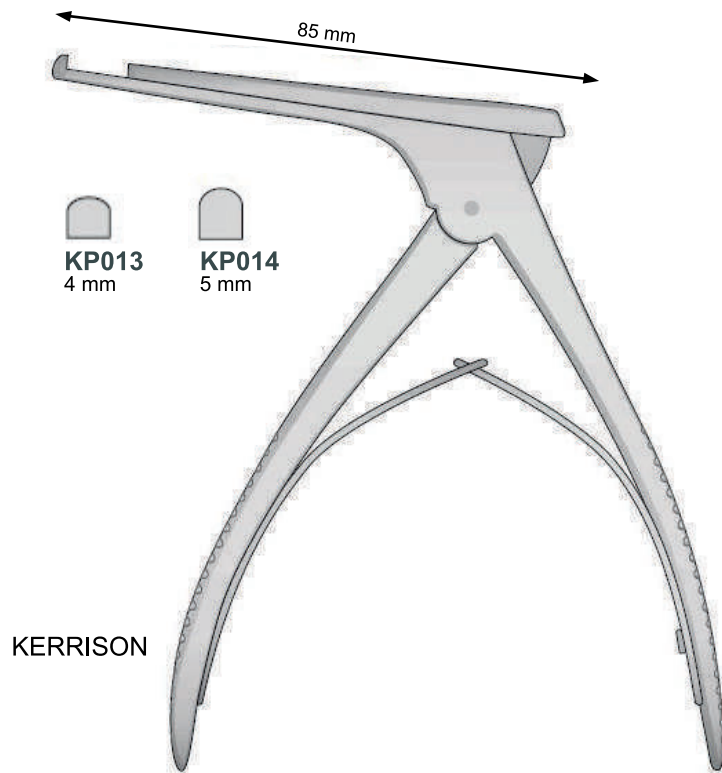
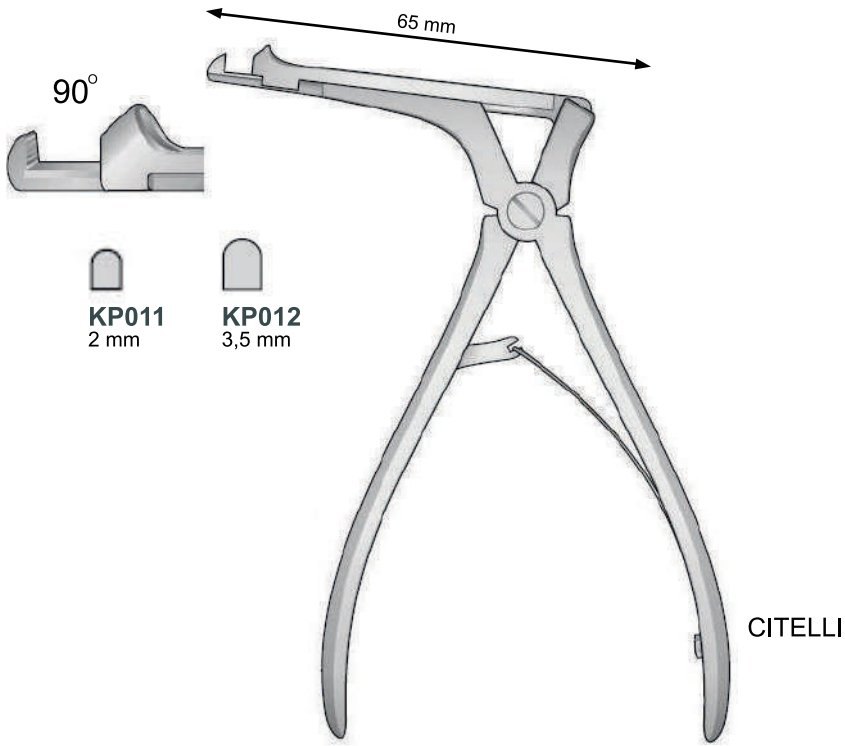

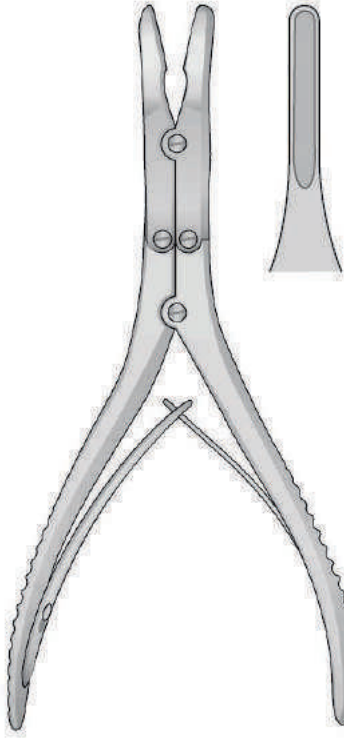

RUSKIN
KP015
190 mm

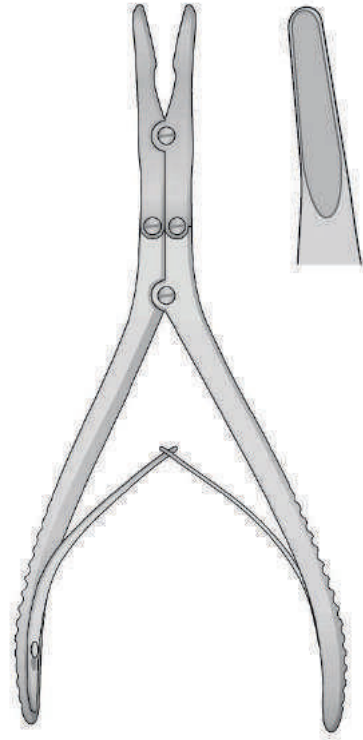

BEYER
KP016
180 mm

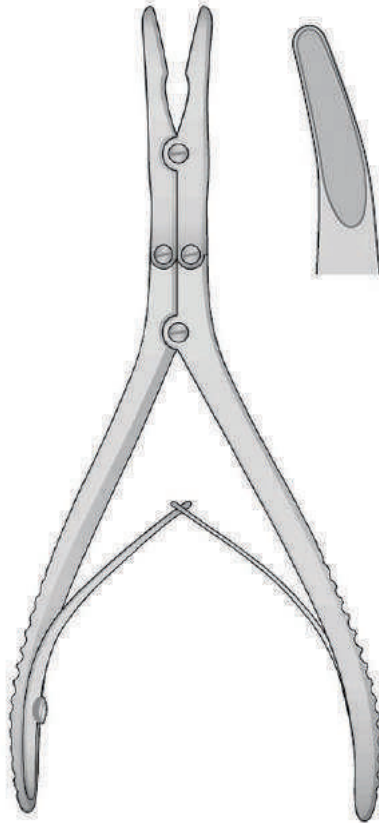

ZAUFAL-JANSEN
KP017
180 mm

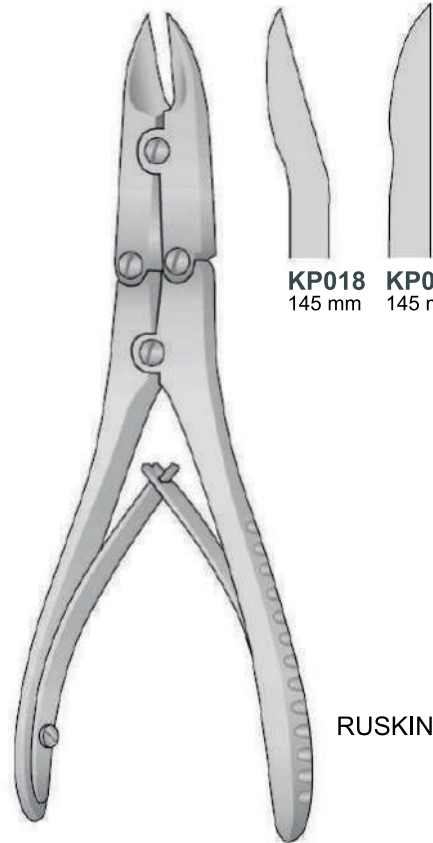

KP018 145 mm
KP019 145 mm

RUSKIN



KK001
145 mm



KK002
145 mm



KK003
145 mm



KK004
145 mm

KERPEL



KK005
170 mm

KK006
170 mm

UFFENORDE



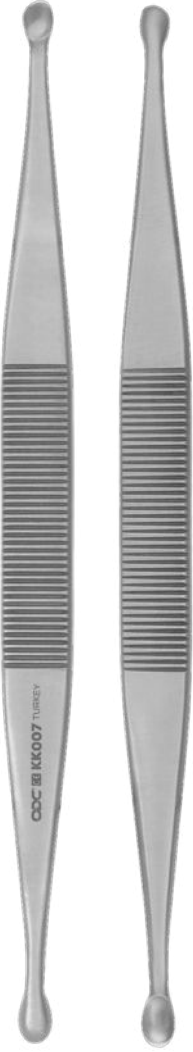

KK007
140 mm
1/1
JACOBSON



KK009
140 mm
1/1
JACOBSON

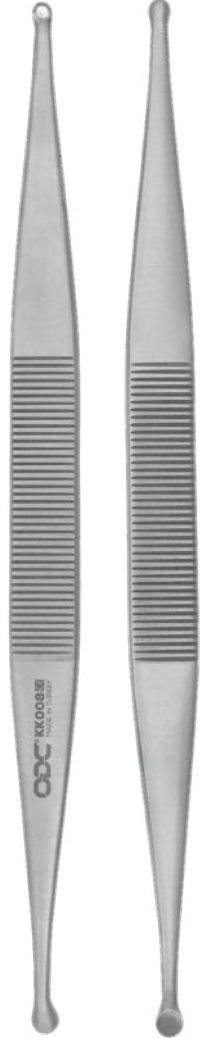

KK008
140 mm
1/1
MARTINI



KK010
145 mm
1/1
WILLIGER

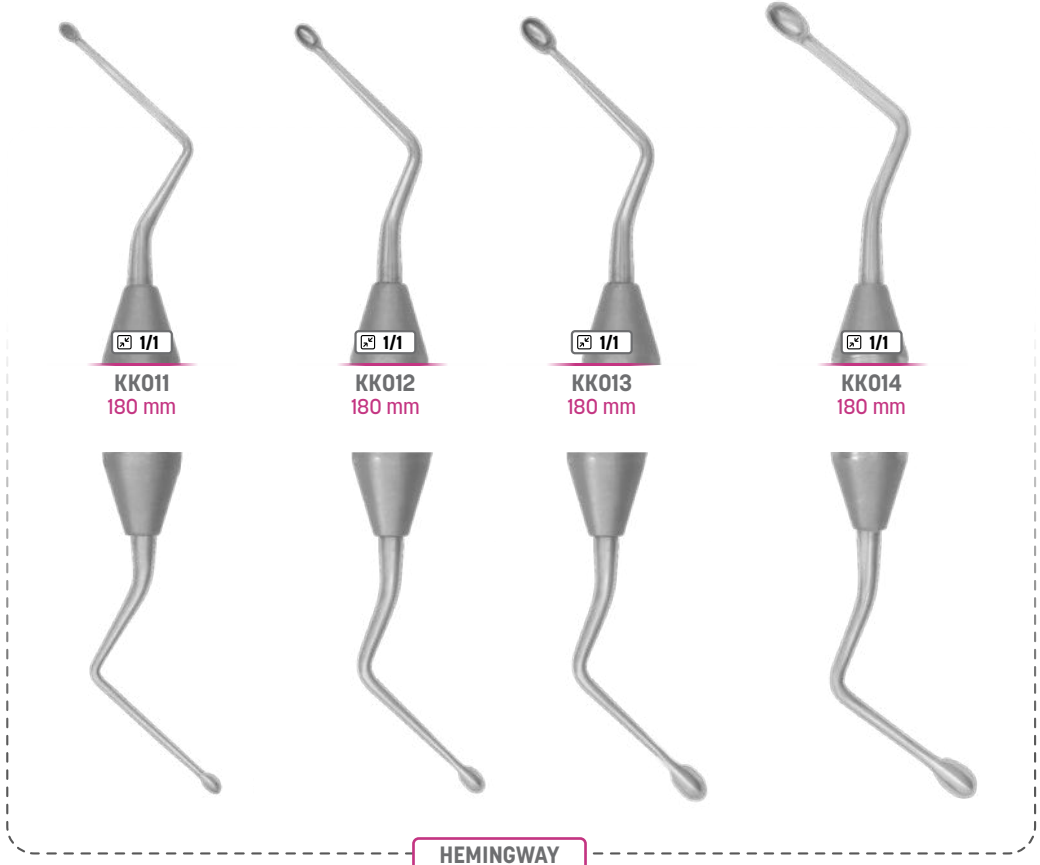

HEMINGWAY





KK015
185 mm
1/1
JANSEN



KK016
180 mm
1/1
BARTH



KK017
185 mm
1/1
VOLKMANN



KK018
170 mm
1/1
VOLKMANN

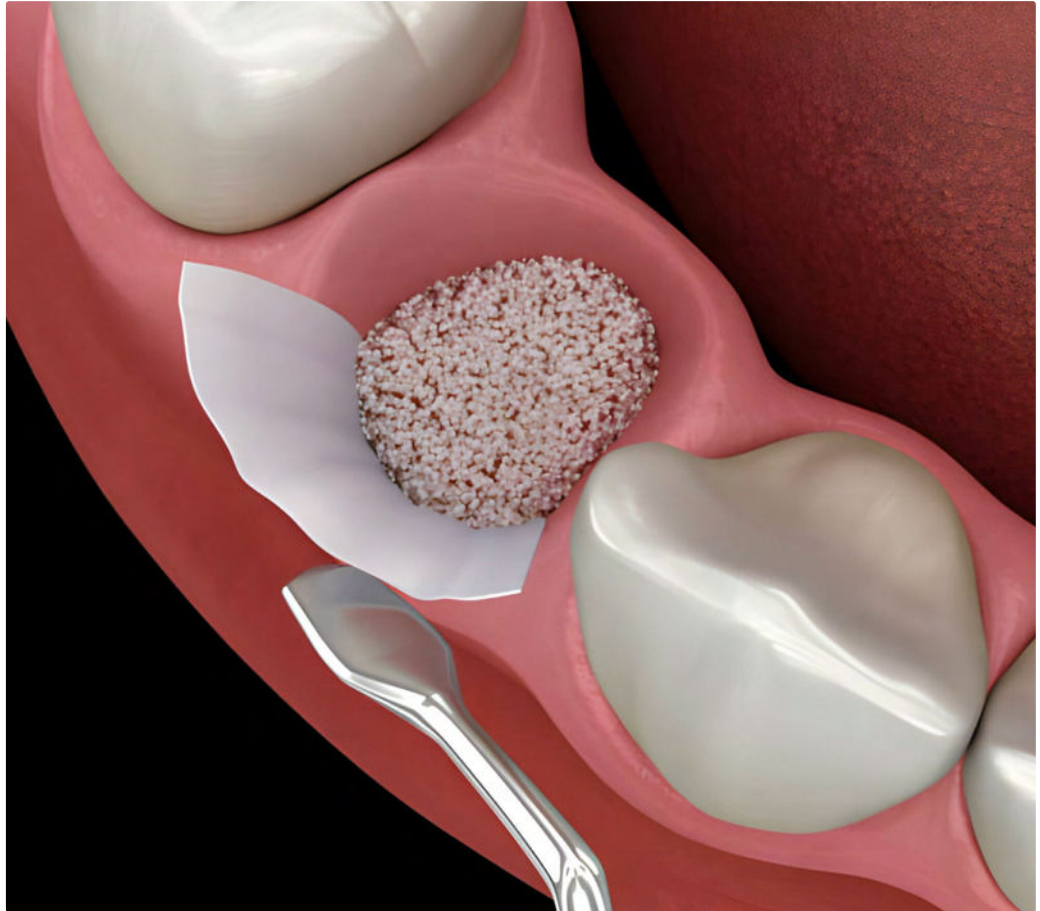
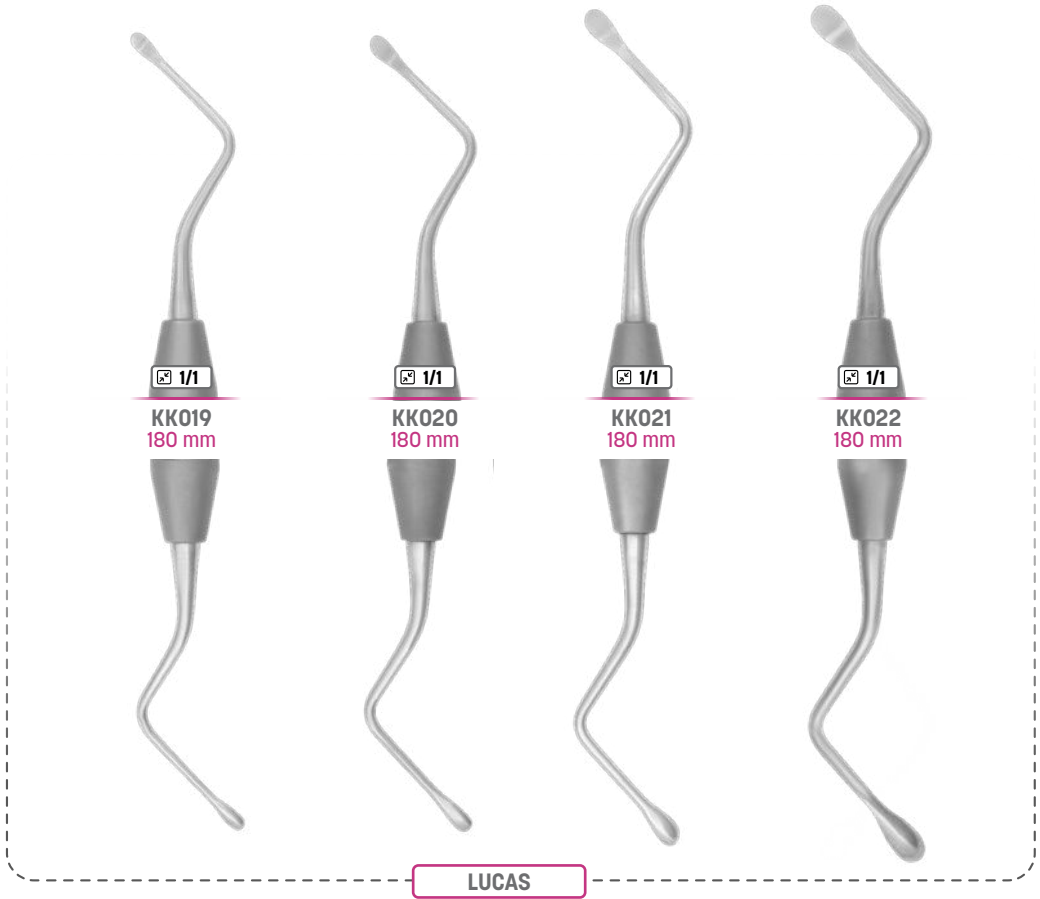



KK023
160 mm
1/1



KK024
160 mm
1/1
JANSEN



KK025
3 mm



KK026
4 mm



KK027
5 mm



KK028
6 mm



KK029
8 mm



KK030
10 mm



KK031
12 mm



67
KE001
180 mm
1/1
HOWARD



45
KE002
185 mm
1/1
MILLER



52
KE003
180 mm
1/1
MILLER



12
KE004
170 mm
1/1
HOWARD



12A
KE005
170 mm
1/1
MILLER



64
KE006
175 mm
1/1
MILLER



KE007
185 mm
1/1
CORD PACKER
ROUNDED



1S / 2S
KE010
180 mm
1/1
SUGARMAN



11 / 12
KE011
?????
1/1
BUCK



9 / 10
KE012
??? mm
1/1
SCHLUGER



11 / 12
KE013
180 mm
1/1
SUGARMAN



????
KE014
????? mm
1/1
????

PERIODONTAL PERIODONTAL

Periodontal küretler, periodontal ceplerden ve düz kök yüzeylerinden diş taşlarını çıkarmak için kullanılır. Kemik Küreti, kemik dokusunu kazımak veya istenen kemik yüzeyinden birikintileri ve fibröz dokuyu çıkarmak için kullanılır.













Problar, periodontal cep derinliğini veya implant uzunluğunu ölçmek için kullanılır.

Periodontal curettes are used to remove calculus from periodontal pockets and flat root surfaces. Bone Curette is used to scrape bone tissue or to remove debris and fibrous tissue from the desired bone surface.
Probes is used to measure the periodontal pocket depth or implant length.





PR020
170 mm
GRACEY
11/14

 PR021 170 mm 12/13 GRACEY	 PR022 170 mm 1 DE MARCO	 PR023 170 mm 2 DE MARCO		
 PR024 170 mm 2R/2L COLUMBIA	 PR025 170 mm 4R/4L COLUMBIA	 PR026 170 mm 13/14 COLUMBIA	 PR027 170 mm 1/2 LANGER	 PR028 170 mm 3/4 LANGER
 PR029 170 mm 11/12 McCall	 PR030 170 mm 13/14 McCall	 PR031 170 mm 13S/14S McCall	 PR032 170 mm 17/18 McCall	



1/1

PR033
170 mm
1

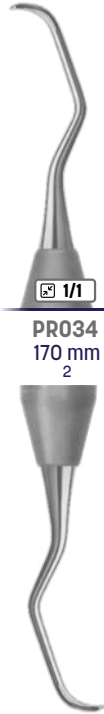

1/1

PR034
170 mm
2



1/1

PR035
170 mm
3



1/1

PR036
170 mm
4



1/1

PR037
170 mm
5

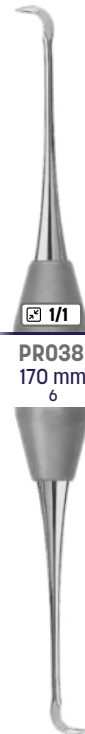

1/1

PR038
170 mm
6

GOLDMAN-FOX



1/1

PR090
170 mm

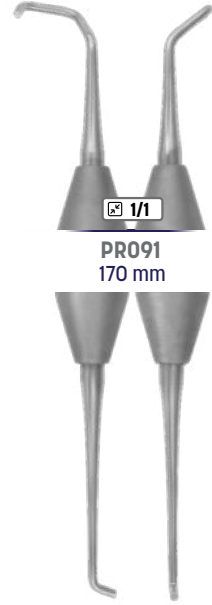

1/1

PR091
170 mm



PR092
170 mm



PR093
170 mm



1/1

KN001
170 mm
KIRKLAND
15K/16K



1/1

KN002
170 mm
ORBAN
1/2



1/1

KN003
170 mm
GOLDMAN FOX
7

PERİODONTAL BIÇAKLAR



1/1
KN004
170 mm
1



1/1
KN005
170 mm
2



1/1
KN006
170 mm
1



1/1
KN007
170 mm
2

BUCK



1/1
KN008
170 mm
8



1/1
KN009
170 mm
9



1/1
KN010
170 mm
11



GOLDMAN-FOX



1/1
KN011
170 mm
1/2



1/1
KN012
170 mm
4/5

SANDERS

STANDART GRACEY SET (PR100)

- Derin Ölçekleme, kök planlaması ve periodontal müdahaleler için özel alan.
- Ofset bıçak diş yüzeyi için mükemmel bir çalışma açısı sağlar.
- Ofset bıçak açısı her bıçağın sadece alt kesme kenarı kullanılır anlamına gelir.

RİGİD GRACEY SET

Rigid Gracey, standart Gracey'den daha kalın, daha güçlü ve daha az esnek bir şafta sahiptir.

MAKRO GRACEY SET

- Terminal şaftı Standart Gracey'den 3 mm daha uzundur.
- Standart Gracey ile karşılaştırıldığında, Bıçak % 50 daha kısa ve % 10 daha incedir.
- Derin, dar ceplerde ölçekleme için iyidir.

MİNİ GRACEY SET

- Derin periodontal ceplere erişmek için tasarlanmış daha uzun Terminal şaft.
- Standart Gracey ile karşılaştırıldığında, dar cepler ve furkasyonlarda daha iyi adaptasyon için bıçak % 50 daha kısadır.

Ön kesici ve köpek dişleri için hafif kontra açısı



Ön kesici ve Kanin dişleri için kısa kontra açısı



Anterior ve premolar için orta kontra açısı



Premolar ve molar dişler, facial ve lingual yüzeyler için orta kontra açısı



Molar buccal ve lingual yüzeyler için uzun kontra açısı ve daha belirgin bir açısı

9/10
PR056
175 mm
1/1
RIGID

9/10
PR057
175 mm
1/1
MAKRO

9/10
PR058
175 mm
1/1
MINI



11/12
PR060
175 mm
1/1
RIGID

11/12
PR061
175 mm
1/1
MAKRO

11/12
PR062
175 mm
1/1
MINI

Arka dişlerin mesial yüzeylerine ulaşmak için gerekli olan açısı



13/14
PR064
175 mm
1/1
RIGID

13/14
PR065
175 mm
1/1
MAKRO

13/14
PR066
175 mm
1/1
MINI

Arka dişlerin distal yüzeylerine ulaşmak için gerekli olan açısı



ÖZEL KASETLERLE SETİNİZİ OLUŞTURUN

- ODC kasetleri, uygulamanızın benzersiz ihtiyaçlarına uyacak şekilde değiştirilebilir.
- Kasetler işlem sırasında keskin parça yaralanmalarının potansiyelini azaltmak için harika bir araçtır.
- Gracey Set sizlere 3 Farklı set halinde sunulmaktadır. (Rigid Set, Makro Set, Mini Set)

SİLİKON SAP GRACEY SET

- Güç iletimi ve hassasiyeti ile ilgili mükemmel şekil, dokunsal bir ölçkleme ve temizlik sağlar.
- Silikon teknolojisi ergonomiktir, hafiftir, ağzın belirli alanlarına dayalı bir renk kodlama sistemi sunar.
- Silikon Saplar son derece ısıya dayanıklı malzemeden üretilmektedir.
- Silikon Gracey Set sizlere 4 Farklı set halinde sunulmaktadır. (Standart Set, Rigid Set, Makro Set, Mini Set)
- Kaset Sterilizasyona Dayanıklı Bir Malzemeden Üretilmiştir.



PR200
Set kaset ile birlikte satılmaktadır.

Set İçeriği (PR200)

- 1/2 ANTERIOR
- 3/4 ANTERIOR
- 5/6 ANTERIOR
- 7/8 BUCCAL / LINGUAL
- 9/10 BUCCAL / LINGUAL
- 11/12 MESIAL / MOLARS
- 17/18 McCALL
- MINI SICKLE
- 23 WILLIAMS

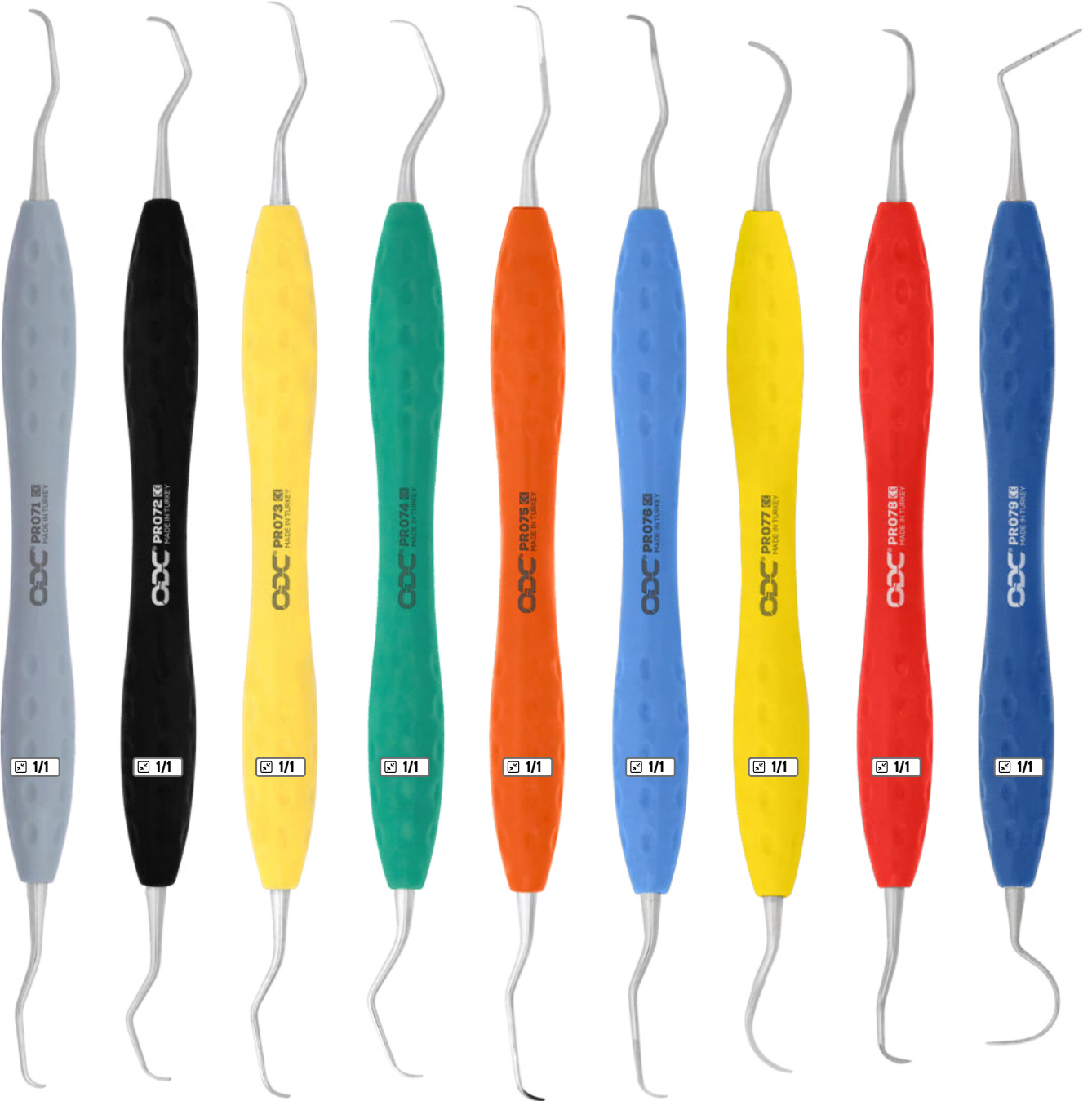

PRO71
170 mm
GRACEY
1/2

PRO72
170 mm
GRACEY
3/4

PRO73
170 mm
GRACEY
5/6

PRO74
170 mm
GRACEY
7/8

PRO75
170 mm
GRACEY
11/12

PRO76
170 mm
GRACEY
13/14

PRO77
170 mm
McCall
17/18

PRO78
170 mm
SICKLE
Mini

PRO79
170 mm
WILLIAMS
23

TİTANYUM İMPLANT SCALERS (PR300)

- İnce eleme ve bilenmiş titanyum işlemi ile kesim kenarları optimize edilmiş keskinliğe sahiptir.
- İmplant bakımı için geliştirilmiş özellikleri, kalkülüs ve biyofilmin çıkarılması mümkündür.
- İmplantlar ve abutmentler olarak aynı titanyum alaşımından yapılmış çalışma uçları, bu hassas yüzeyler üzerinde paslanmaz çelikten daha yumuşaktır.
- Hassas çalışma uçları, hasta konforunu artırarak periodontal ceplere daha fazla erişim sağlarken, geliştirilmiş ergonomi ve görünürlük, diş hekimlerinin en iyi performansı göstermelerine yardımcı olur.



PR080
180 mm
GRACEY
1/2



1/1

PR081
180 mm
GRACEY
3/4

1/1

PR082
180 mm
GRACEY
5/6

1/1

PR083
180 mm
GRACEY
7/8

1/1

PR084
180 mm
GRACEY
11/12

1/1

PR085
180 mm
GRACEY
13/14

1/1

PR086
180 mm
GRACEY
U15/30

1/1

PR087
180 mm
GRACEY
H6/H7

ÖZEL KASETLERLE SETİNİZİ OLUŞTURUN

1/2 Gracey Implant Scalers

3/4 Gracey Implant Scalers

5/6 Gracey Implant Scalers

7/8 Gracey Implant Scalers

11/12 Gracey Implant Scalers

13/14 Gracey Implant Scalers

U15/30 Implant Scalers

H6/H7 Implant Scalers

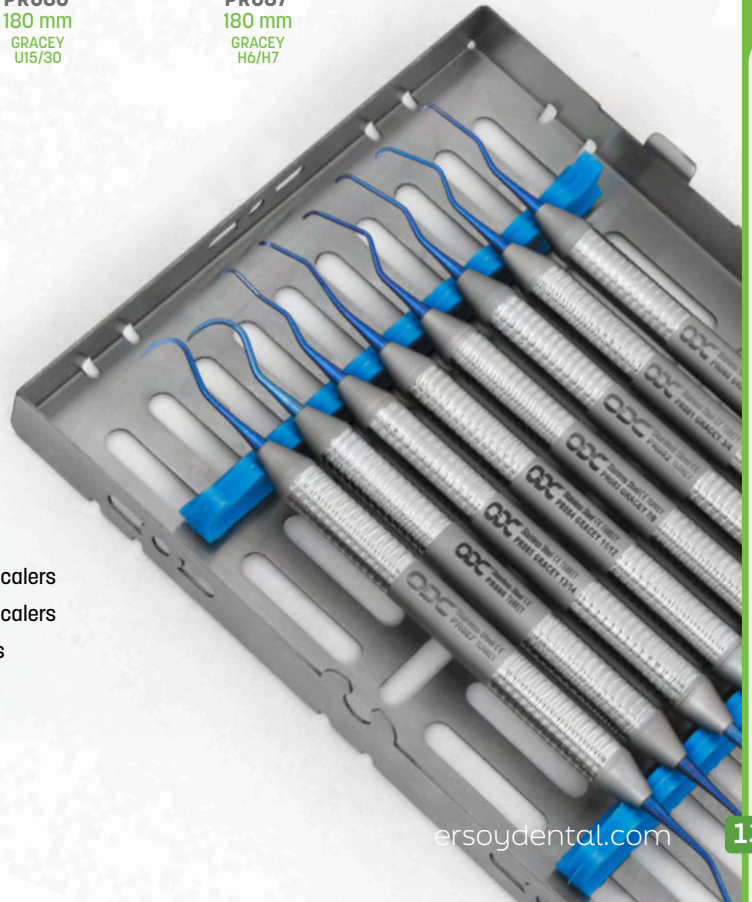



3mm
6mm
8mm
11mm

CP-11
PS001
160 mm
1/1
RIGID



1mm 2mm
3mm
5mm
7mm 8mm
9mm 10mm

CP-10
PS005
160 mm
1/1



3mm
6mm
9mm
12mm

CP-12
PS002
160 mm
1/1



3mm
6mm
8mm
11mm

NABER
PS006
160 mm
1/1



5mm
10mm
15mm

CP-15UNC
PS003
160 mm
1/1



MARYLAND
PS007
160 mm
1/1



3,5mm
5,5mm
7,5mm

WHO
PS004
160 mm
1/1



- 1mm
- 2mm
- 3mm
- 5mm
- 7mm
- 8mm
- 9mm
- 10mm

WILLIAMS
PS008
160 mm
1/1
RIGID

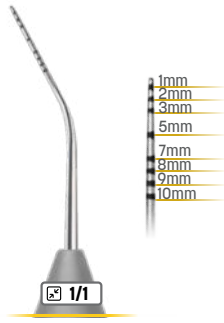

PS009
180 mm
MERRIT A



PS010
180 mm
MERRIT B

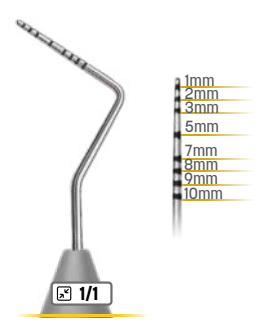

PS011
180 mm
GOLDMAN-FOX



PS012
180 mm
UNIVERSITY OF MICHIGAN



PS013
180 mm
26 G



PS014
180 mm
???????

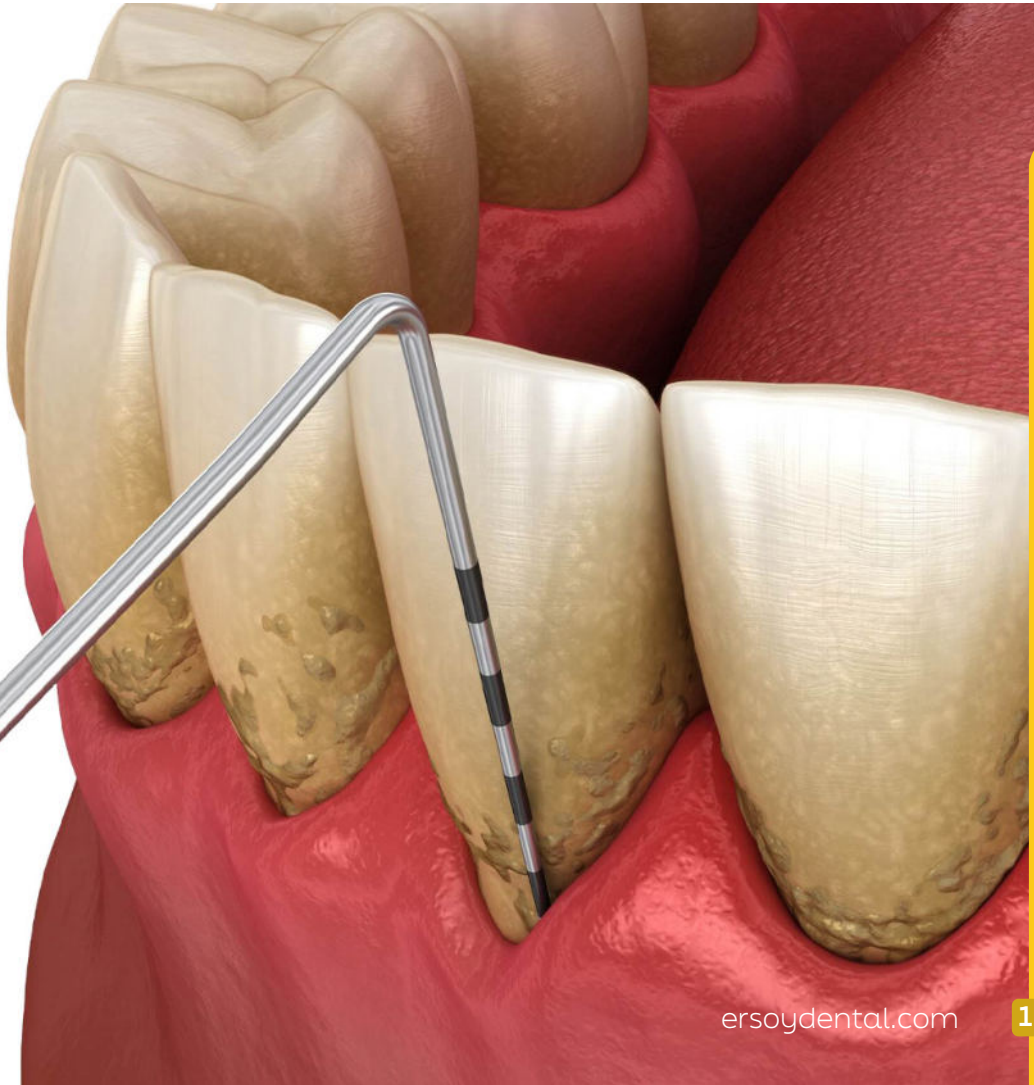



PD027
165 mm
OCHSEMBEIN
1
1/1



PD028
165 mm
OCHSEMBEIN
2
1/1



PD029
170 mm
TG CHISELS
2
1/1



PD030
170 mm
OCHSEMBEIN
3
1/1



PD031
170 mm
OCHSEMBEIN
4
1/1



PD032
175 mm
FEDI
1
1/1



PD033
175 mm
FEDI
2
1/1



PD034
170 mm
FEDI
3
1/1



PD035
170 mm
OCHSEMBEIN
4
1/1



PD036
170 mm
RHODES BACK ACTION
1/1



KT001
170 mm
U15/J30
1/1



KT002
170 mm
J14/15
1/1



KT003
170 mm
NVO
1/1



KT004
170 mm
NV11/12
1/1



KT005
170 mm
NV13/14
1/1



KT006
170 mm
TAYLOR
2/3
1/1



KT007
170 mm
204
1/1



KT008
170 mm
204S
1/1



KT009
170 mm
204SD
1/1



KT010
170 mm
2/3
1/1



KT011
170 mm
CRANE-CAPLAN
6
1/1



KT012
170 mm
YOUNGER-GOOD
7/8
1/1



KT013
170 mm
RULE
23/24
1/1



KT014
170 mm
I. UNIVERSITY
17/18
1/1



KT015
170 mm
TOWNER-JAQUETTE
U15/J33
1/1



KT016
170 mm
TOWNER-JAQUETTE
H5/J33
1/1



KT017
170 mm
TOWNER-JAQUETTE
H6/H7
1/1





KT018
170 mm
1/1



KT019
170 mm
1/1

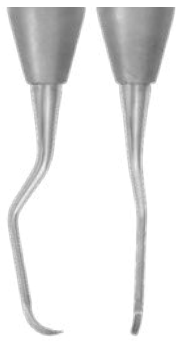

KT020
170 mm
1/1



KT021
170 mm
1/1



KT022
170 mm
1/1



KT023
170 mm
1/1



KT024
170 mm
1/1



KT025
170 mm
1/1



KT026
170 mm
1/1



KT028
170 mm
1/1



KT029
170 mm
1/1



KT030
170 mm
1/1

KOMPOZİT ALETLER COMPOSITE INSTRUMENTS

Endodontik prosedürlerde, Ekskavatörler çürükleri ve yumuşak dentini kavite duvarlarından ve zeminlerinden kazıp çıkarmak ve bunları diş dolguları için hazır hale getirmek için kullanılır. Daha sonra temizlenen bölgeye dolgu malzemesi yerleştirilir. Bu dolgu maddesini (amalgam vb.) yerleştirmek, oymak ve şekillendirmek için kompozit aletler kullanılır.

In endodontic procedures, Excavators are used to excavate and remove caries and soft dentin from cavity walls and floors, making them ready for dental fillings. Then the filling material is placed on the cleaned area. Composite instruments are used to place, carve and shape this filling material (amalgam etc.). For this reason, the products come into contact with archwire, coil springs, metal band, elastic band (auxiliary attachments), bracket, teeth, blood and bonding (adhesive) according to their intended use.



ERSOY
DENTAL

ODC
CERRAHI ALETLER

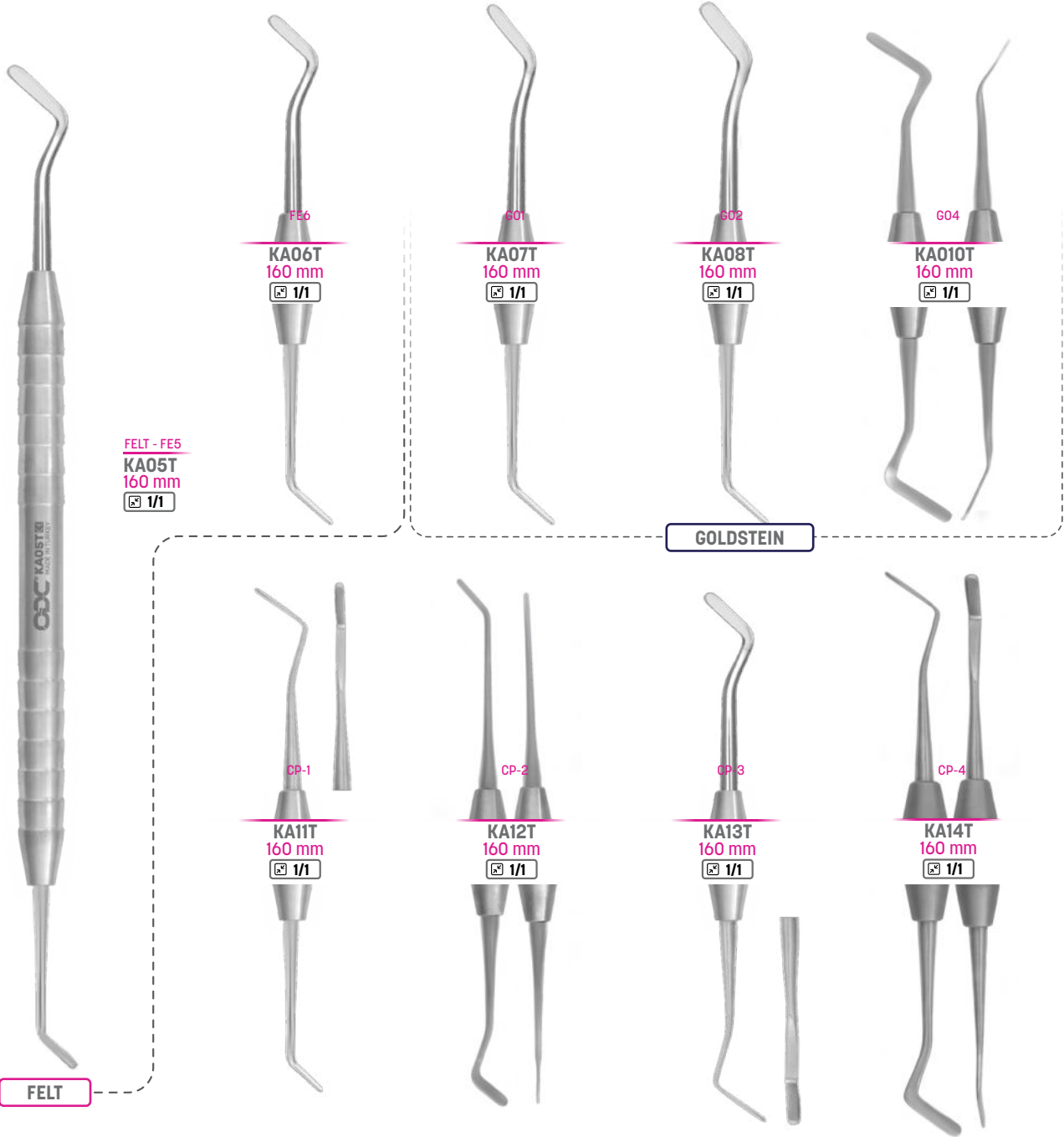



1
KA001
160 mm
1/1



2
KA002
160 mm
1/1



3
KA003
160 mm
1/1

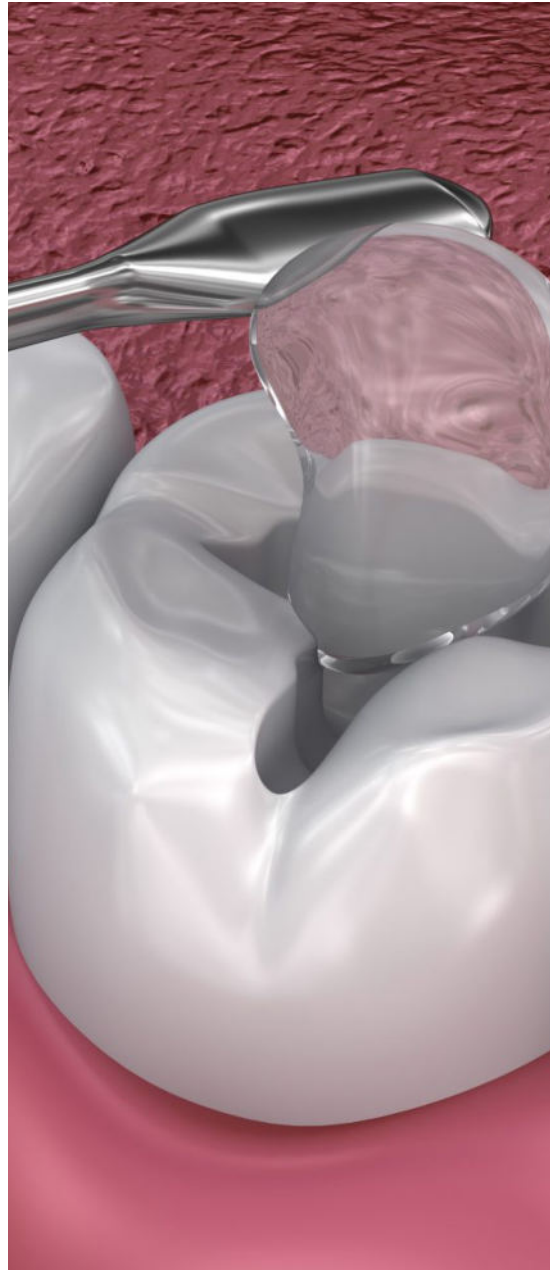

KA009
160 mm
USC
1/1



KA010
160 mm
FRAHM
1/1



1/2
KA011
160 mm
1/1



4/5
KA012
160 mm
1/1



3/6
KA014
160 mm
1/1



1
KA015
160 mm
1/1



KA016
160 mm
1/1



KA017
160 mm
1/1



KA018
160 mm
1/1



KA019
160 mm
1/1



KA020
160 mm
1/1



KA021
160 mm
1/1



1
KA022
160 mm
1/1



2
KA023
160 mm
1/1



3
KA024
160 mm
1/1



1L
KA025
160 mm
1/1



2L
KA026
160 mm
1/1



3L
KA027
160 mm
1/1

TIRTIKLI SERRATED

DÜZ SMOOTH

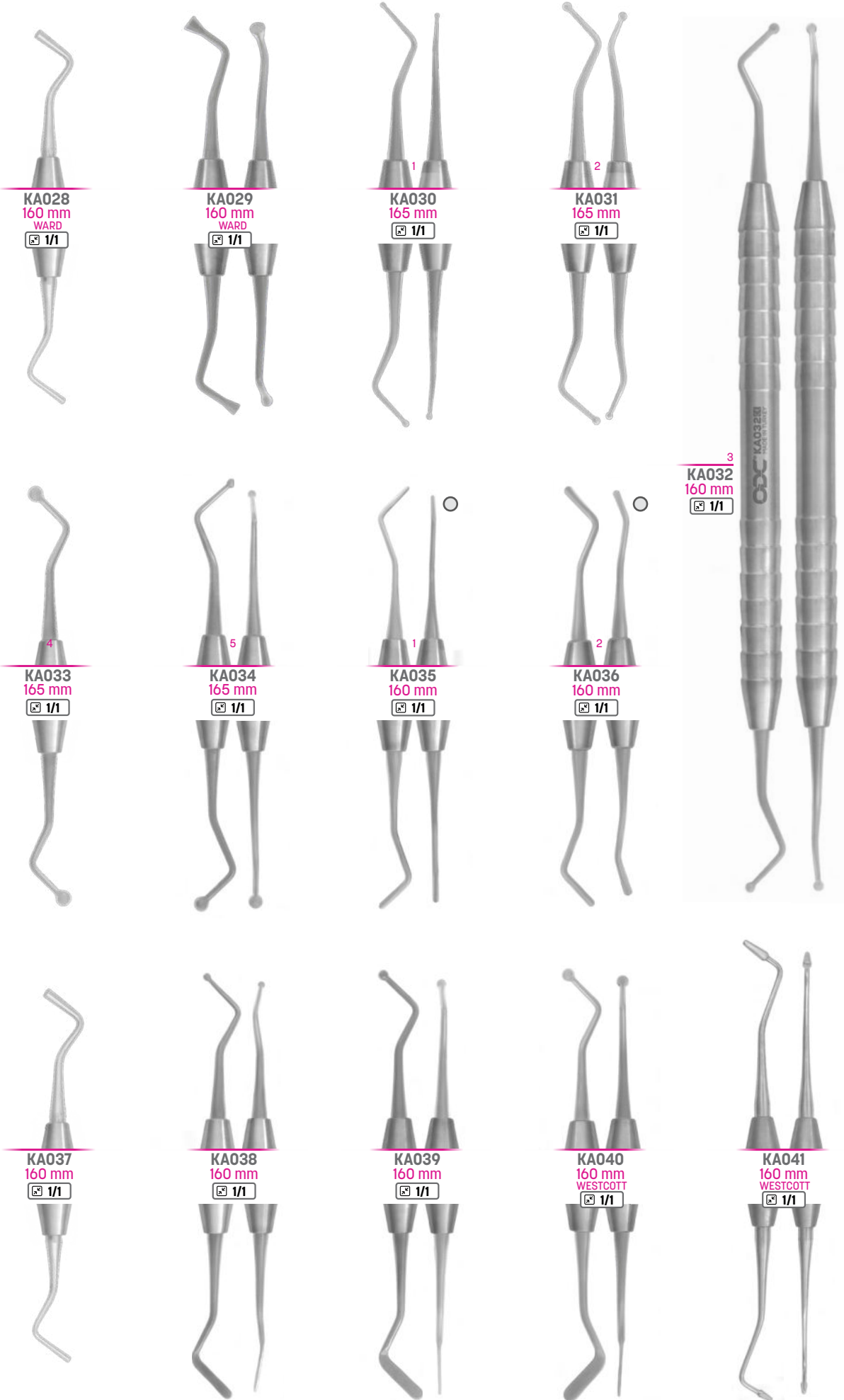



KA042
160 mm
☒ 1/1



KA043
160 mm
☒ 1/1



KA044
160 mm
☒ 1/1

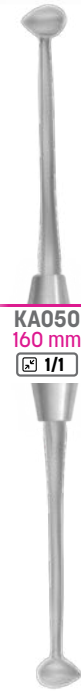

KA050
160 mm
☒ 1/1



KA051
160 mm
☒ 1/1



KA052
160 mm
☒ 1/1

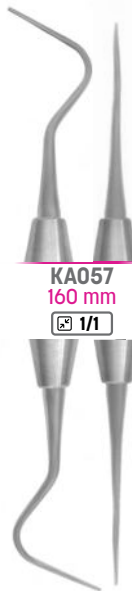

KA057
160 mm
☒ 1/1



KA058
165 mm
☒ 1/1



KA059
165 mm
☒ 1/1



KA060
160 mm
☒ 1/1



KA061
160 mm
☒ 1/1



KA062
160 mm
☒ 1/1





KA70A
170 mm
1/1



KA70C
170 mm
1/1



KA70E
170 mm
1/1



KA70F
170 mm
1/1



KA70M
170 mm
1/1

KOMPOZİT ŞEKİLENDİRİCİ SET



KA70B
170 mm
1/1



KA70D
170 mm
1/1



KA70H
170 mm
1/1



KA70K
170 mm
1/1



KA70L
170 mm
1/1

KOMPOZİT ŞEKİLLENDİRİCİ SET (ALTERNATİF SEÇENEKLER)



1/1

RD001



1/1

RD002



1/1

RD003



1/1

RD004



1/1

RD005



1/1

RD006



1/1

RD007



1/1

RD008



1/1

RD013



1/1

RD014



AINSWORTH
RD009
160 mm
1/1



RD010
160 mm
1/1

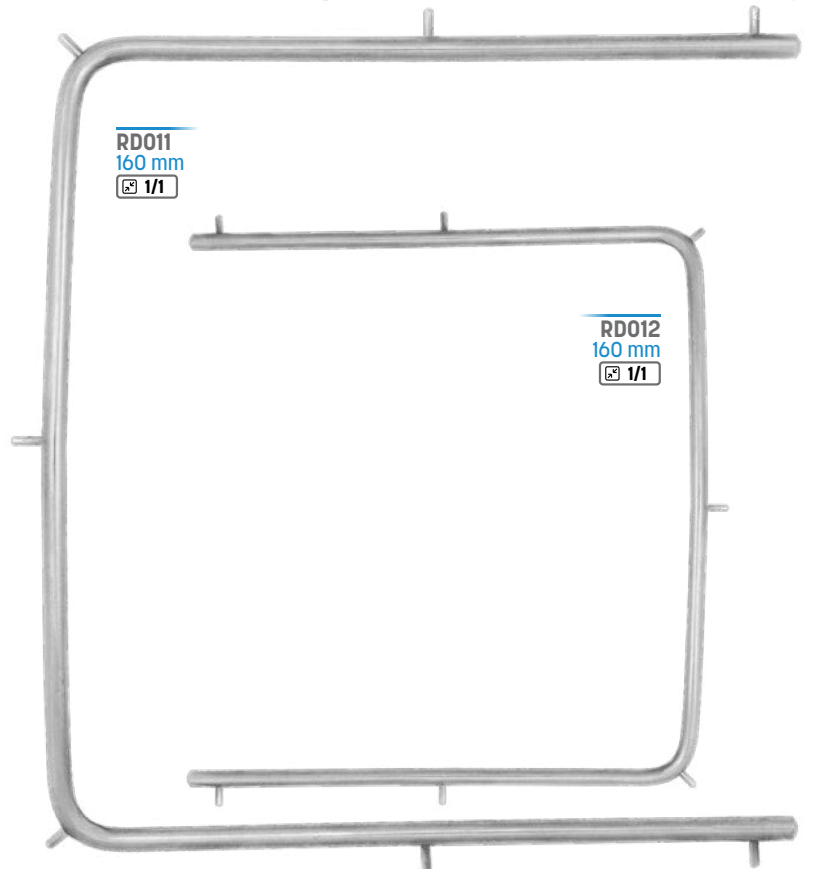

RD011
160 mm
1/1

RD012
160 mm
1/1

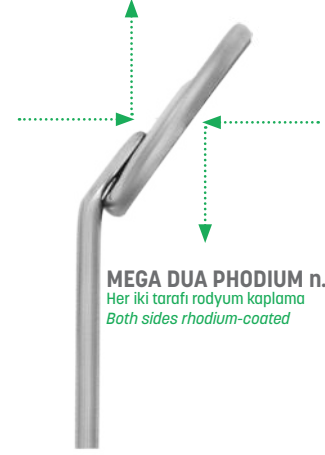
#3 - Ø 18 mm
AY001#4 - Ø 22 mm
AY002#5 - Ø 24 mm
AY003#4 - Ø 22 mm
AY004**MEGA DUA PHODIUM n.4**
Her iki tarafı rodyum kaplama
Both sides rhodium-coatedBasit Gövde
AY005
120 mm
☑ 1/1Kronik Soket
AY006
120 mm
☑ 1/1Basit Gövde
AY007
125 mm
☑ 1/1Kronik Soket
AY008
125 mm
☑ 1/1AY009
120 mm
☑ 1/1AY010
120 mm
☑ 1/1AY011
120 mm
☑ 1/1

Solid

Hollow



PB001
170 mm
23
1/1



PB002
170 mm
11
1/1



PB003
170 mm
6
1/1



PB004
170 mm
9
1/1



PB005
170 mm
2
1/1



PB006
170 mm
10
1/1



PB007
170 mm
12
1/1



PB008
170 mm
6A
1/1



PB009
170 mm
8A
1/1



PB010
170 mm
17A
1/1



PB011
170 mm
3A
1/1



PB012
170 mm
3
1/1



AT001



AT002

METAL TİP

Ø 35 mm
h. 35 mm
AT003inox
STAINLESS
STEELAT004
170 mmAT005
160 mmOTOKLAVLANABİLİR
PLASTİK TİP

YUKARI EĞRİ
CURVED UP
Ø 0,9 mm

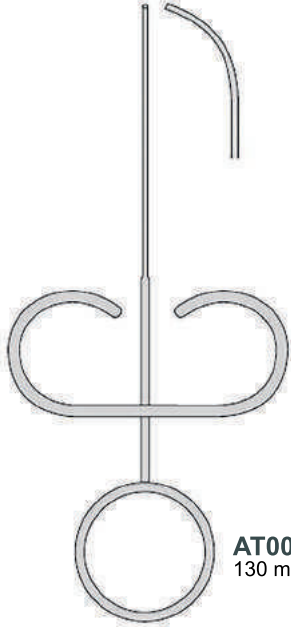

YANA EĞRİ
CURVED TO SIDE
Ø 0,9 mm

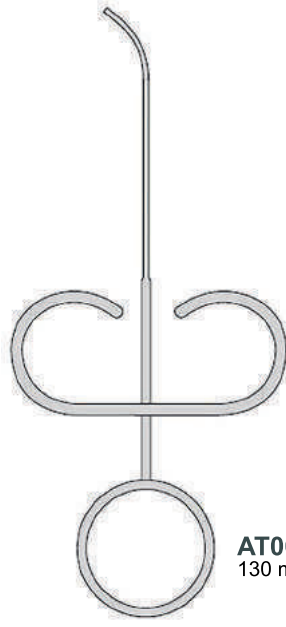

DÜZ
STRAIGHT
Ø 1,2 mm

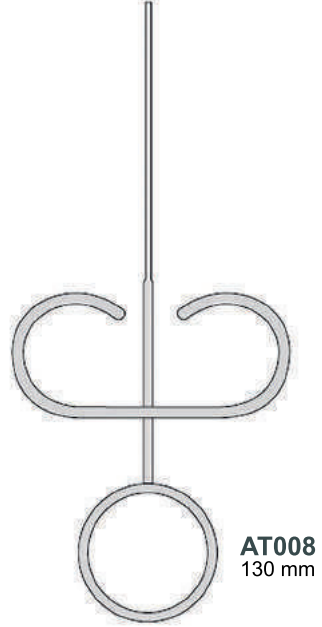

YANA EĞRİ
CURVED TO SIDE
Ø 1,2 mm

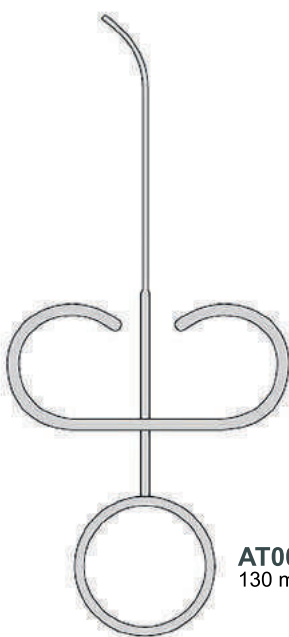

YUKARI EĞRİ
CURVED UP
Ø 1,2 mm

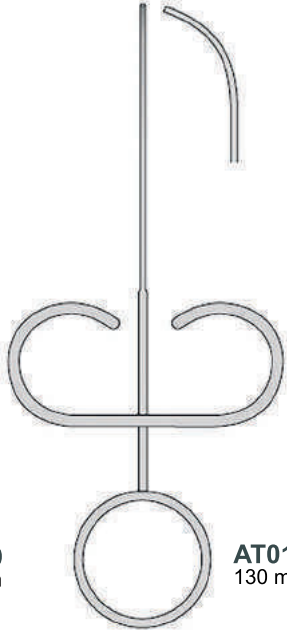

YANA EĞRİ
CURVED TO SIDE
Ø 1,8 mm

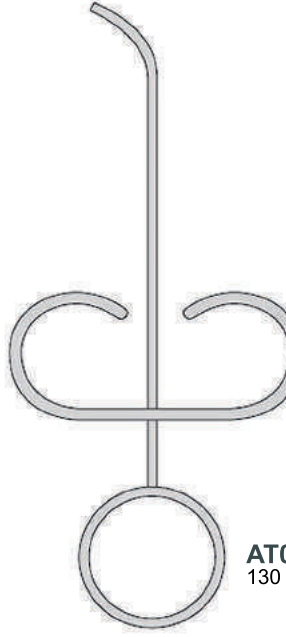

YUKARI EĞRİ
CURVED UP
Ø 1,8 mm

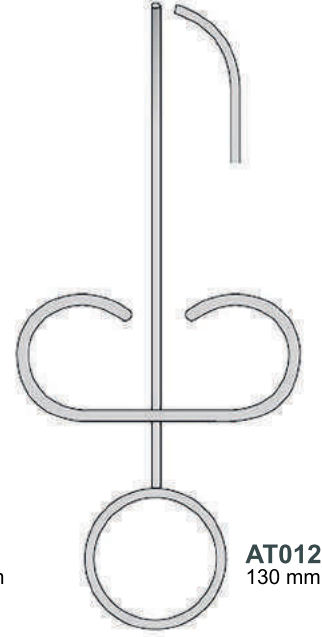

Büyük Ağı, 12 Parça
Molars, 12 pieces



1
MT015



2
MT017



40/3
MT019

Küçük Ağı, 12 Parça
Premolars, 12 pieces



41/4
MT016



41/5
MT018



41/6
MT020

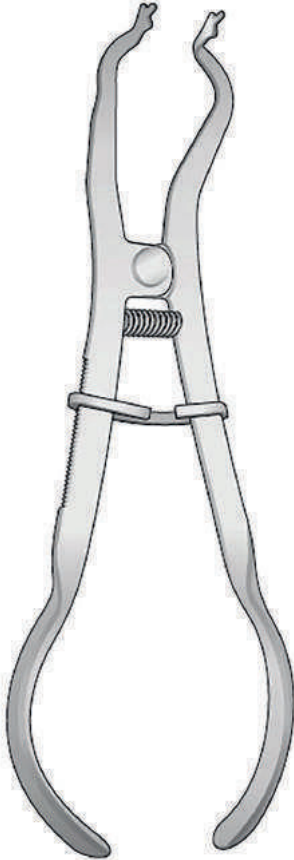

IVORY
MT021
170 mm

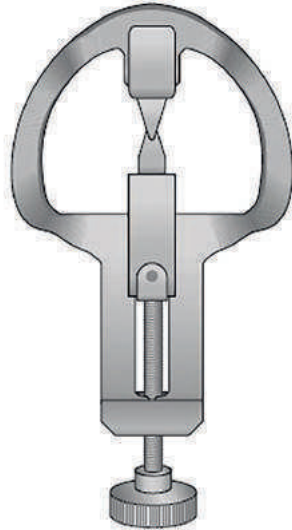

14
IVORY
MT022

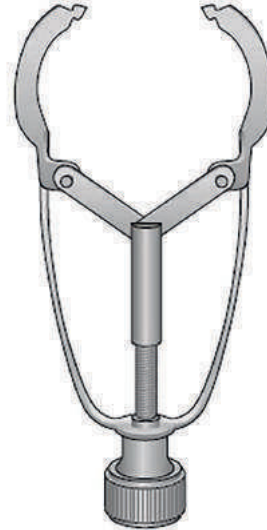

1
IVORY
MT023

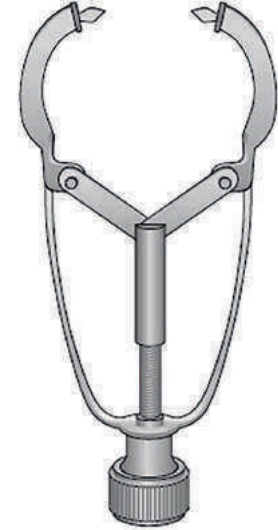

12
IVORY
MT024

Büyük Ağı, 12 Parça
Molars, 12 pieces

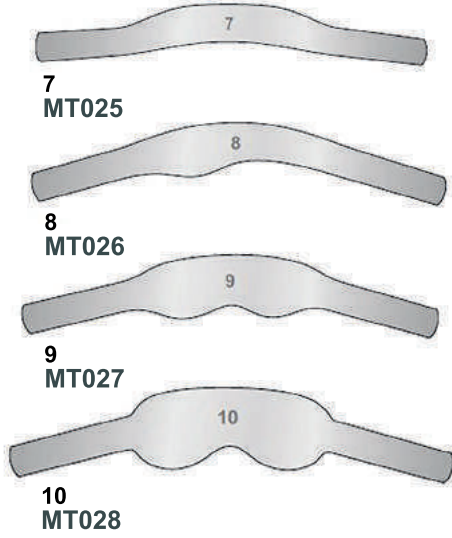

Küçük Ağı, 12 Parça
Premolars, 12 pieces

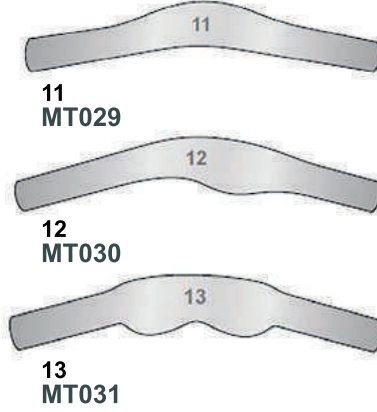

TOFFLEMIRE
Evrensel
Üniversal

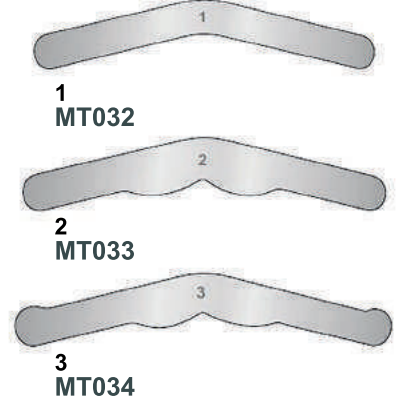

MT035 5 mm x 1mt
MT036 6 mm x 1mt
MT037 7 mm x 1mt



MT038 5 mm x 5mt
MT039 6 mm x 5mt
MT040 7 mm x 5mt

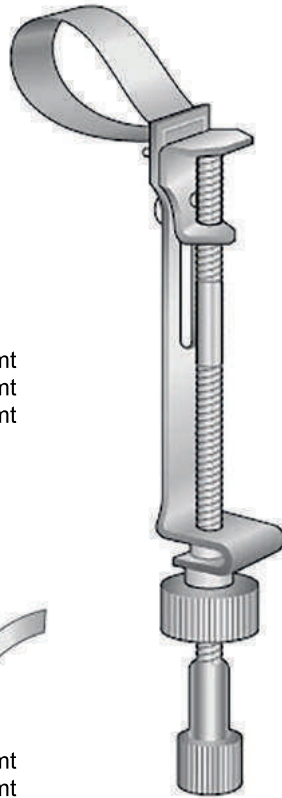

8
IVORY

MT041 5 mm
MT042 6 mm
MT043 7 mm



1
SAĞ
RIGHT



2
SOL
LEFT

1 - 2
NYSTRÖM
MT044



TOFFLEMIRE
MT045
Evrensel





SP001
180 mm
1/1



SP002
180 mm
1/1



SP003
180 mm
1/1



SP004
200 mm
1/1



SP005
140 mm
1/1



SP006
180 mm
1/1



SP007
185 mm
1/1



EV001
170 mm
0
1/1



EV002
170 mm
1
1/1



EV003
170 mm
2
1/1



EV005
170 mm
4
1/1



EV006
170 mm
5
1/1



EV007
170 mm
6
1/1



EV004
170 mm
3
1/1

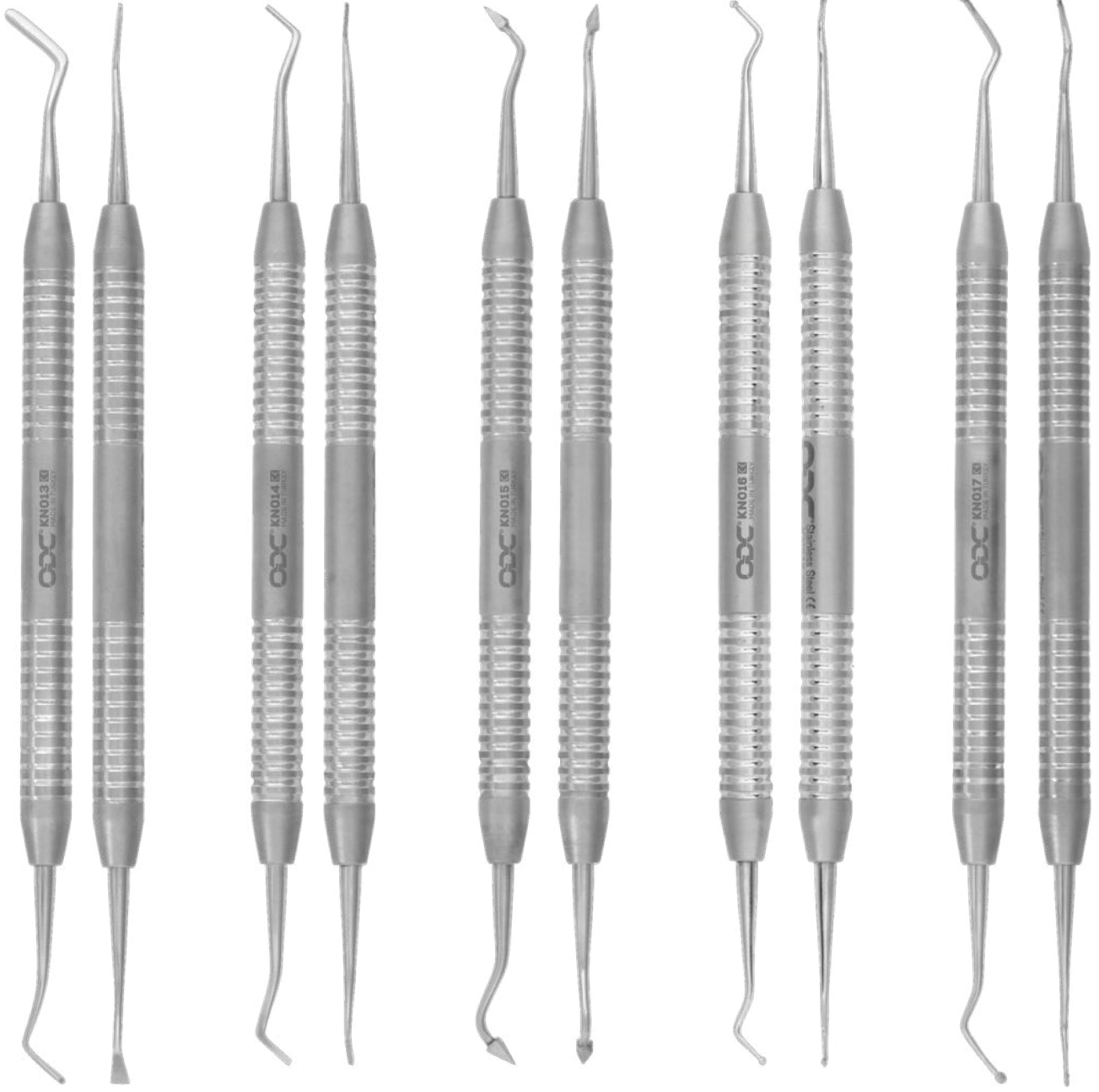

KN013
170 mm
1/1

KN014
170 mm
1/1

KN015
170 mm
1/1

KN016
170 mm
1/1

KN017
170 mm
1/1

**Dış Hekimlerinin Bulmakta Zorlandığı
ART El Aletleri,
Artık Türkiye'de Üretiliyor.**

Dentists' Struggle to Find
Advanced Dental Tools
Now Produced in Turkey.



CERRAHİ SURGICAL

Cerrahi alet, ameliyat sırasında kullanılan bir tıbbi cihazdır. Aletlerin bozulması veya kırılması, cerrahi süreci uzatabilir, ekip stresini artırabilir ve istenmeyen komplikasyonlara yol açabilir. Dolayısıyla cerrahi girişimin başarısında cerrahi el aletlerinin yeri tartışılmazdır.

A surgical instrument is a medical device used during surgery. The malfunction or breakage of instruments can prolong the surgical process, increase team stress, and lead to unwanted complications. Therefore, the role of surgical hand instruments is indisputable in the success of a surgical procedure.



ERSOY
DENTAL

ODC
CERRAHİ ALETLER

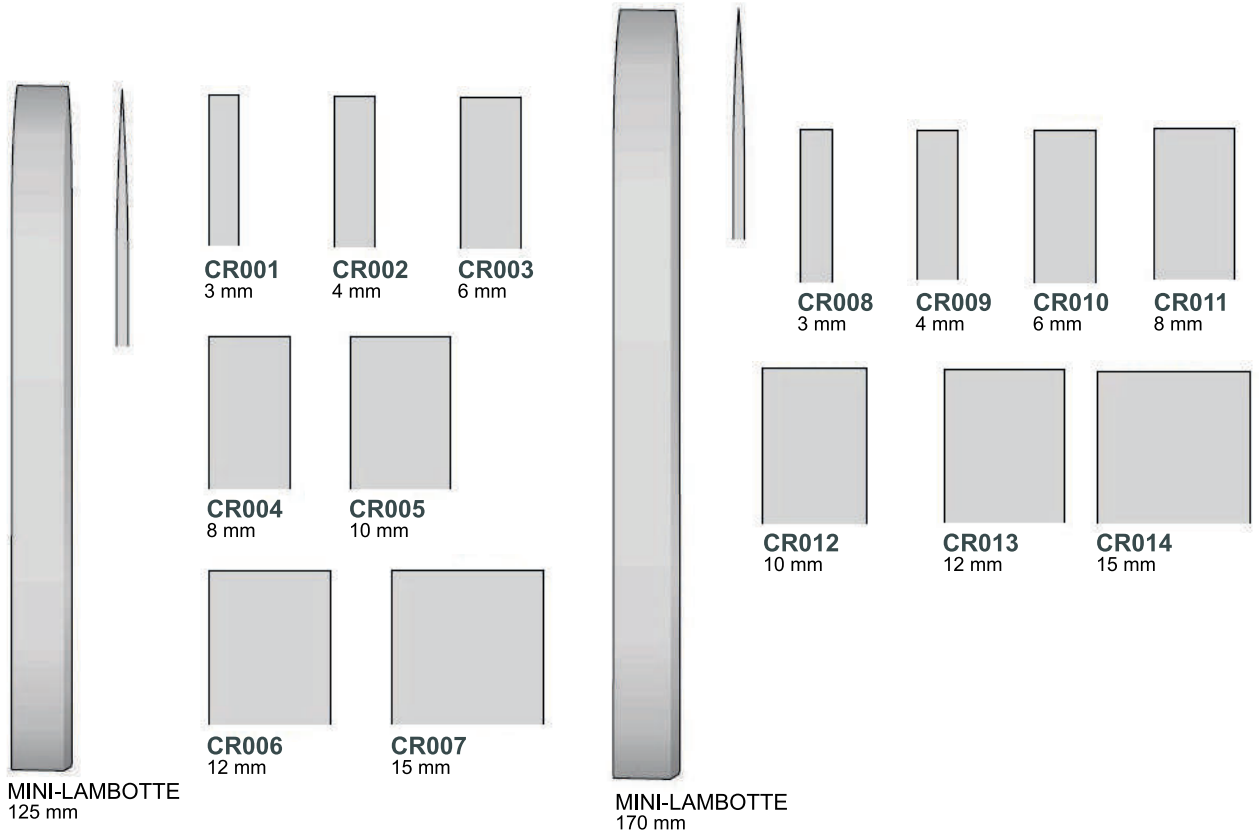

TEK TARAFLI KESİM

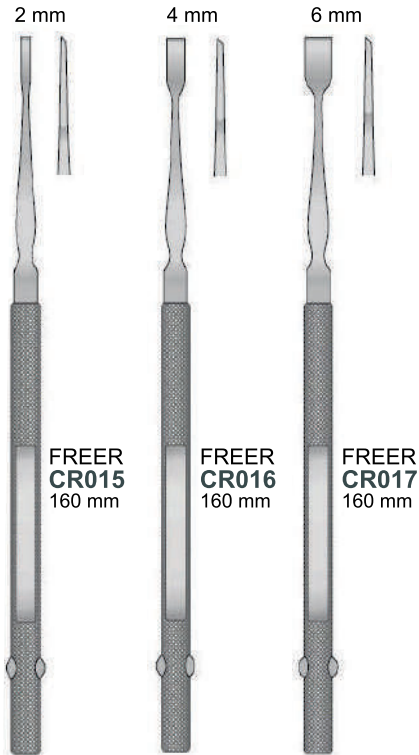

ÇİFT TARAFLI KESİM

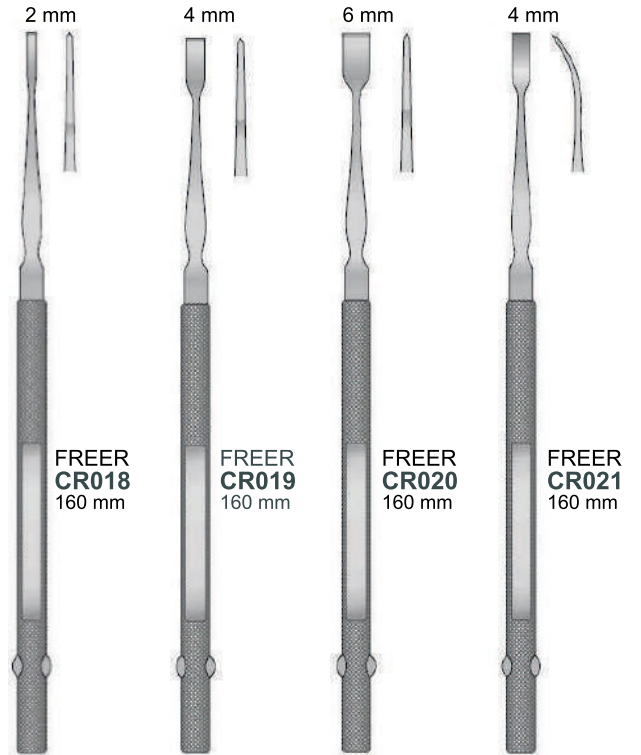

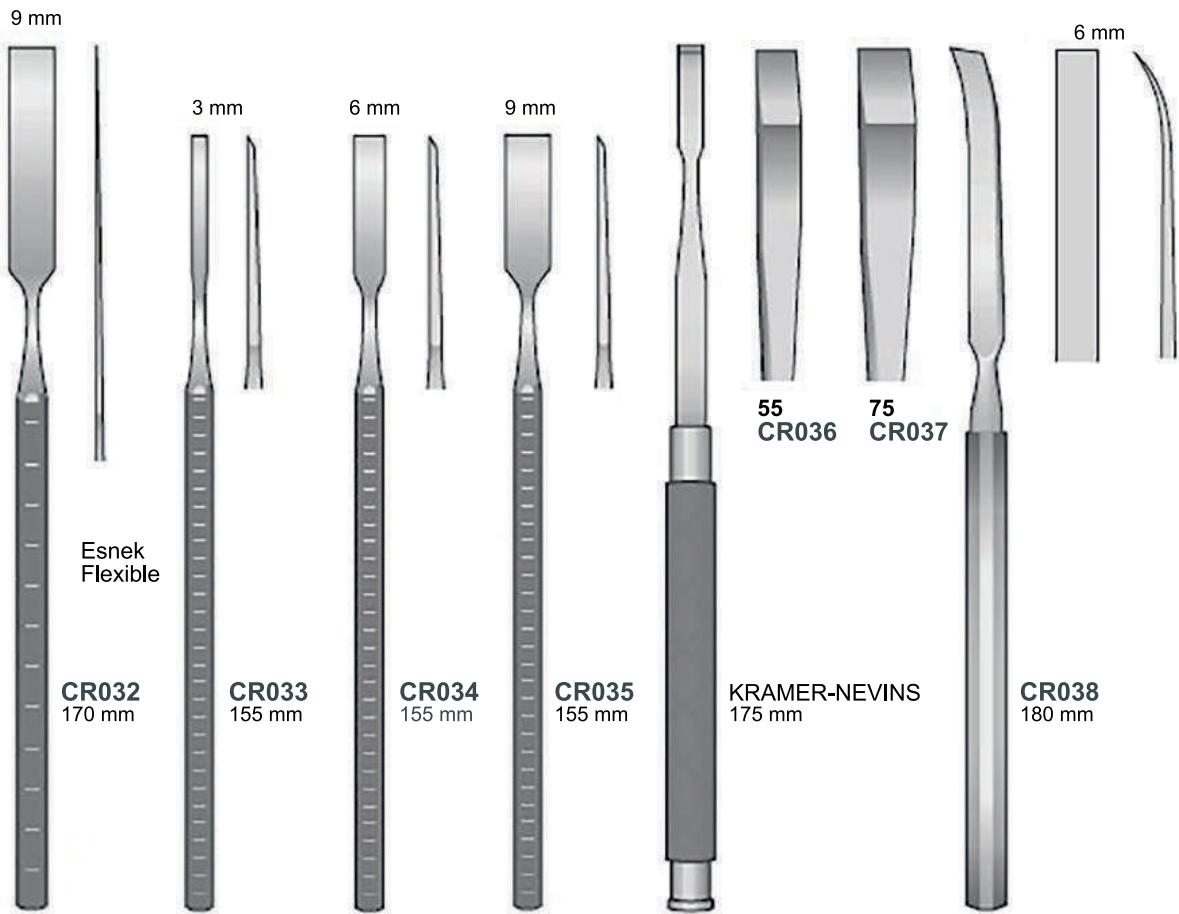
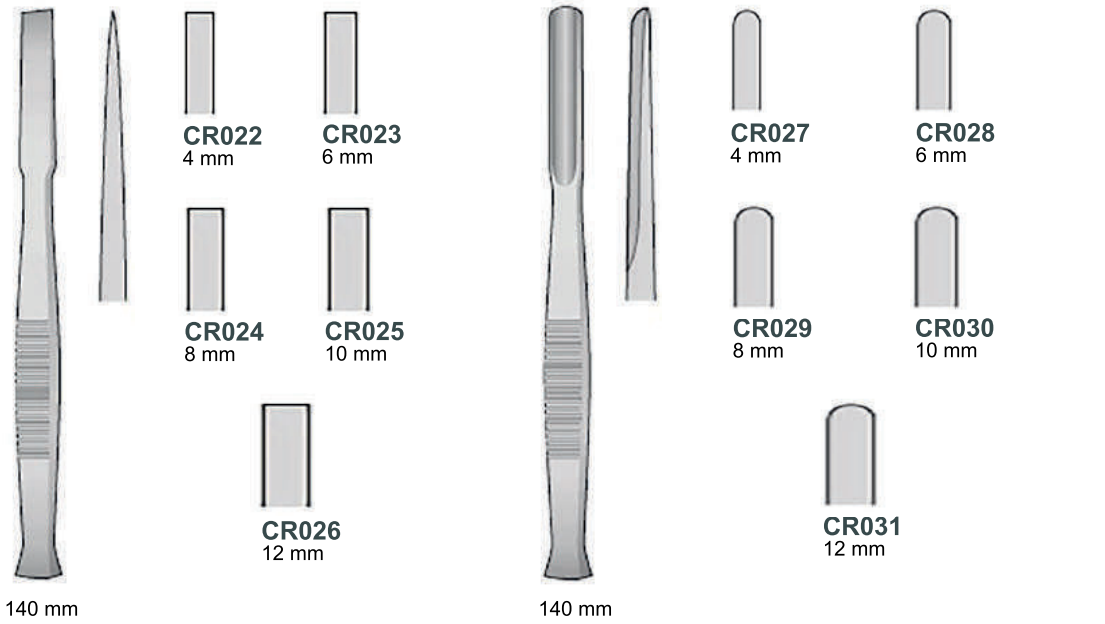

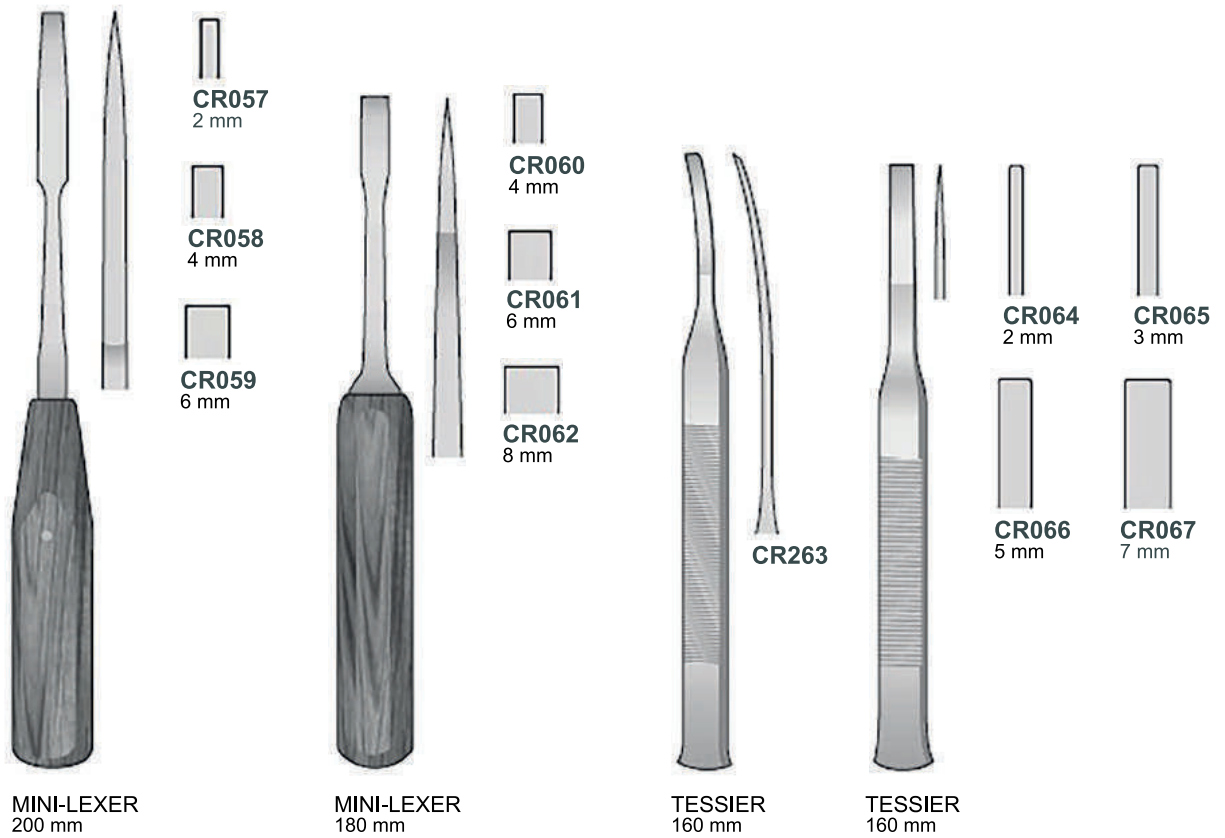
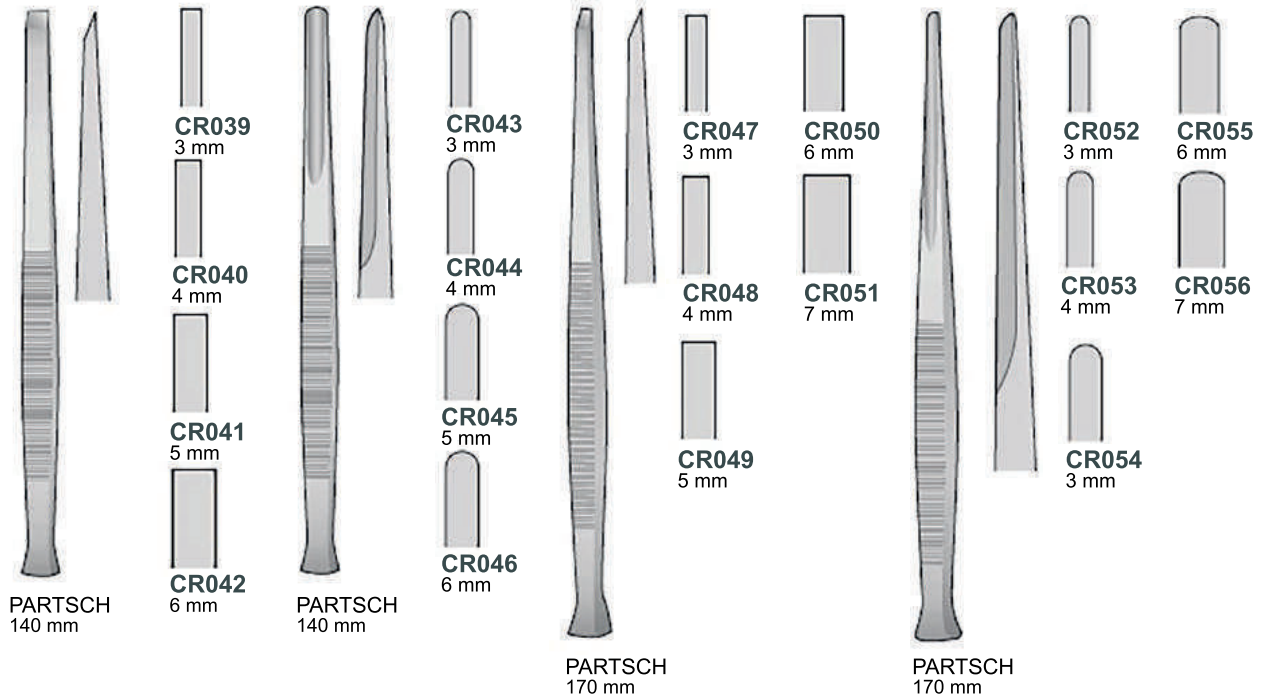

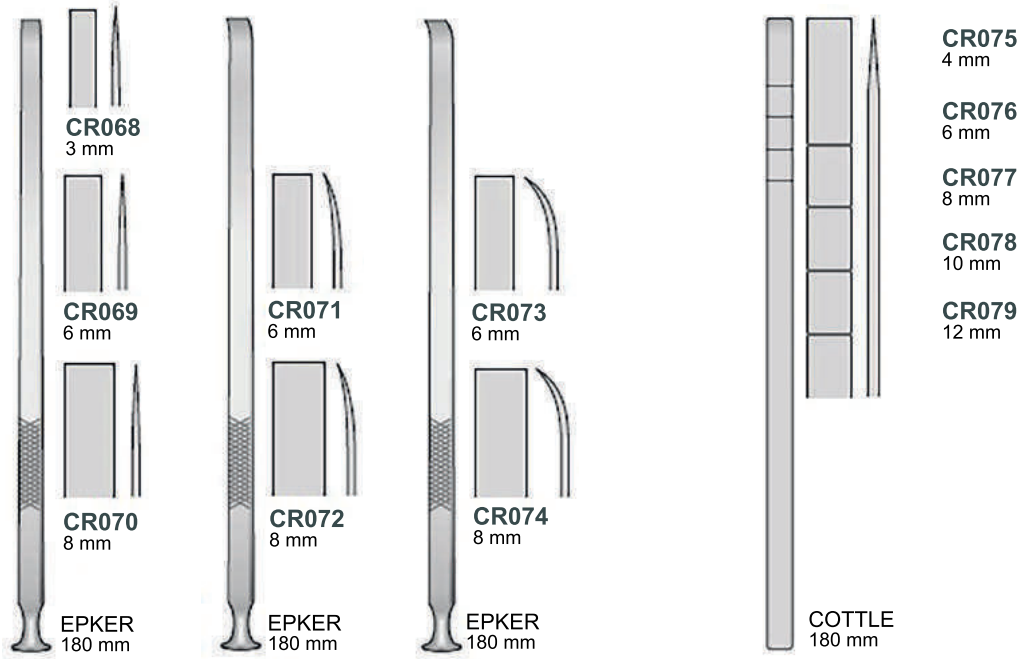
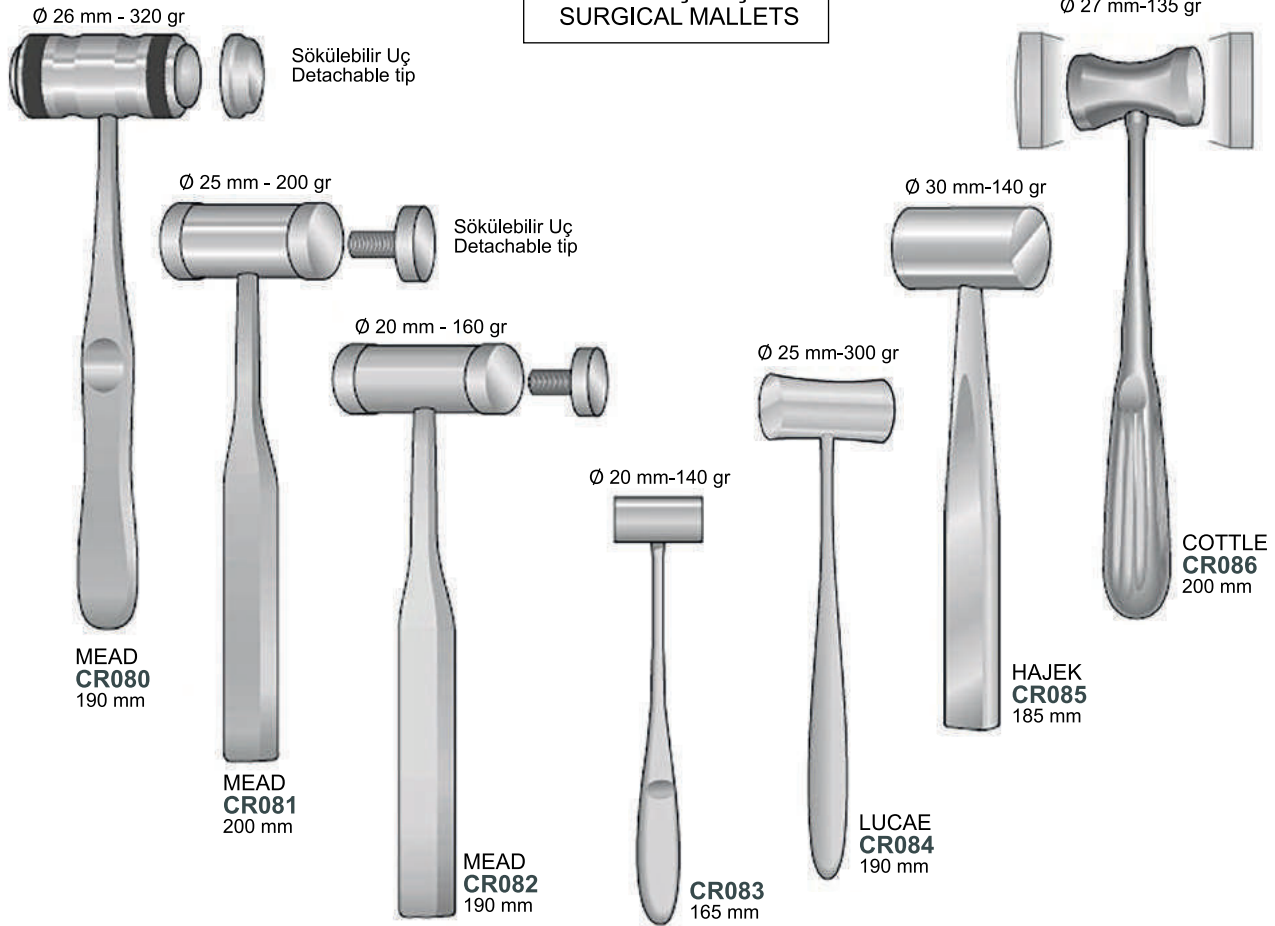
CERRAHI ÇEKİÇLER
SURGICAL MALLETS

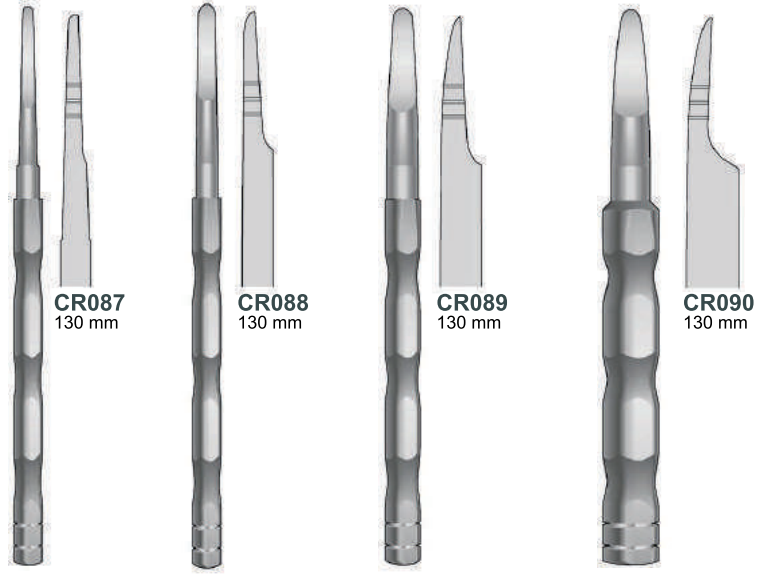
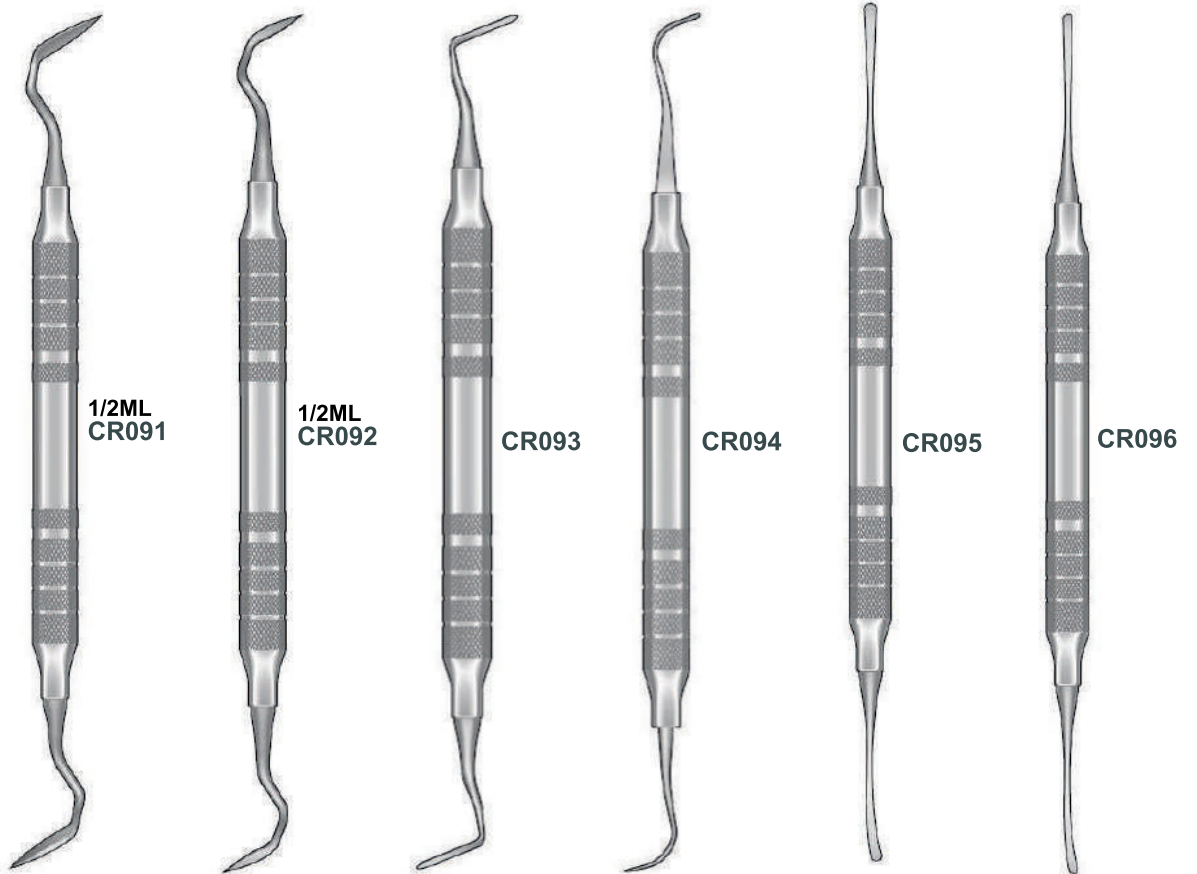
KEMİK GENİŞLETİCİLER
BONE EXPANDERSTÜNEL AÇMA ALETLERİ
TUNNELING INSTRUMENTS

1	Ölçü
0	Ø 1.60
7.5	Ø 1.80
10	Ø 2.00
13.5	Ø 2.40
15.5	Ø 3.60

2	Ölçü
0	Ø 1.90
7.5	Ø 2.20
10	Ø 2.35
13.5	Ø 3.60
15.5	Ø 4.40
21.5	Ø 4.50

3	Ölçü
0	Ø 2.80
7.5	Ø 3.20
10.5	Ø 3.35
13.5	Ø 3.60
21	Ø 4.40

4	Ölçü
0	Ø 3.10
7.5	Ø 3.70
10.5	Ø 3.90
15.5	Ø 4.30

5	Ölçü
0	Ø 3.90
10	Ø 5.00
13	Ø 5.20
20,5	Ø 6.30

6	Ölçü
0	Ø 5.50
10	Ø 6.20
13	Ø 6.30

1
Ø 1.6 mm



CR097
155 mm

2
Ø 1.9 mm



CR098
155 mm

3
Ø 2.8 mm



CR099
155 mm

4
Ø 3.10 mm



CR100
155 mm

5
Ø 3.90 mm



CR101
155 mm

6
Ø 5.50 mm



CR102
155 mm

1	Ölçü	2	Ölçü	3	Ölçü	4	Ölçü	5	Ölçü
0	Ø 1.50	0	Ø 2.10	0	Ø 2.60	0	Ø 3.00	0	Ø 3.50
5	Ø 1.90	5	Ø 2.60	5	Ø 3.00	5	Ø 3.50	5	Ø 3.90
8	Ø 2.20	8	Ø 2.80	8	Ø 3.30	8	Ø 3.80	8	Ø 4.20
10	Ø 2.40	10	Ø 3.00	10	Ø 3.50	10	Ø 4.00	10	Ø 4.40
12	Ø 2.60	12	Ø 3.20	12	Ø 3.70	12	Ø 4.20	12	Ø 4.60
14	Ø 2.80	14	Ø 3.40	14	Ø 3.90	14	Ø 4.40	14	Ø 4.80

1
Ø 1.6 mm



CR103
155 mm

2
Ø 1.9 mm



CR104
155 mm

3
Ø 2.8 mm



CR105
155 mm

4
Ø 3.10 mm



CR106
155 mm

5
Ø 3.90 mm



CR107
155 mm

6
Ø 5.50 mm



CR108
155 mm



CR109
155 mm



CR110
155 mm

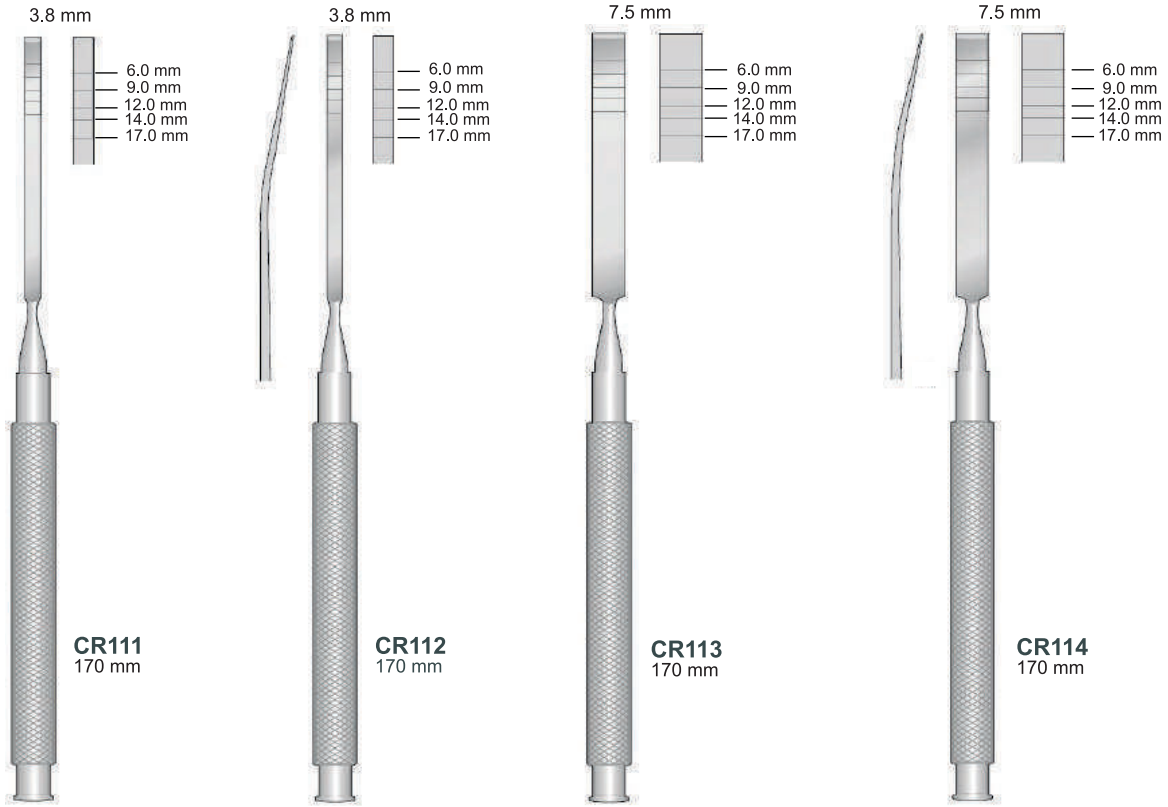

Sinüslift Küretleri
Sinuslift Kurettens



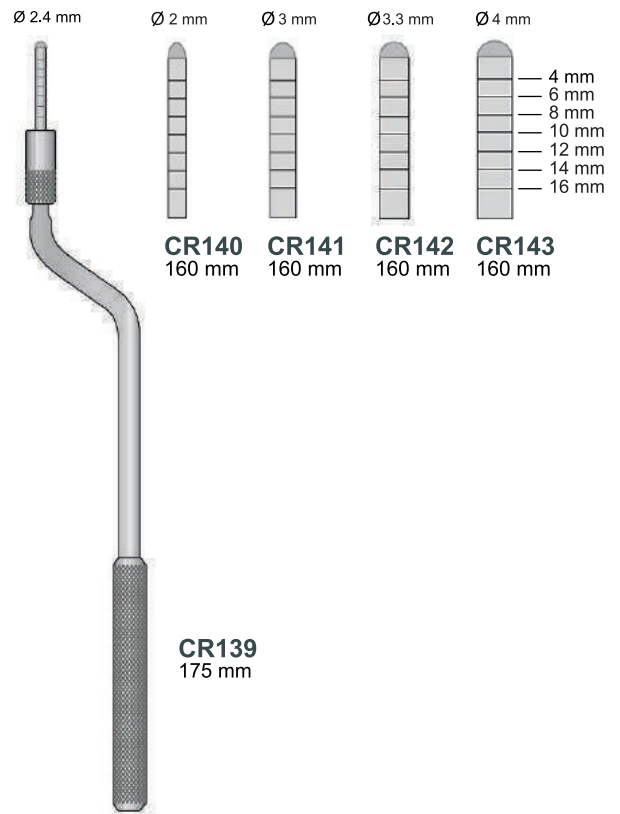
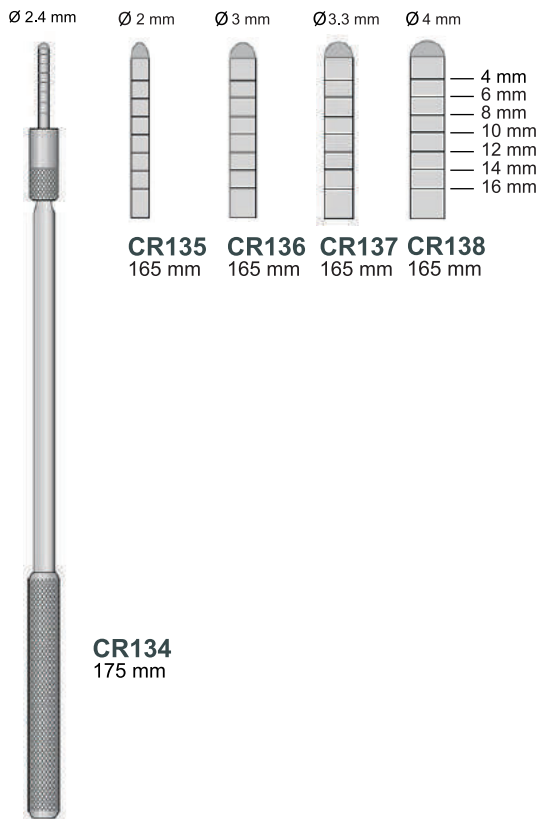
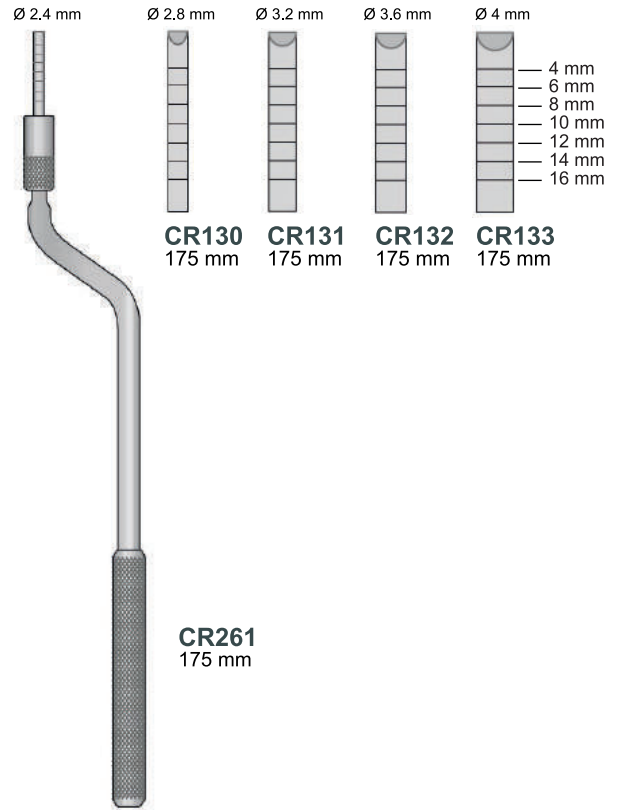
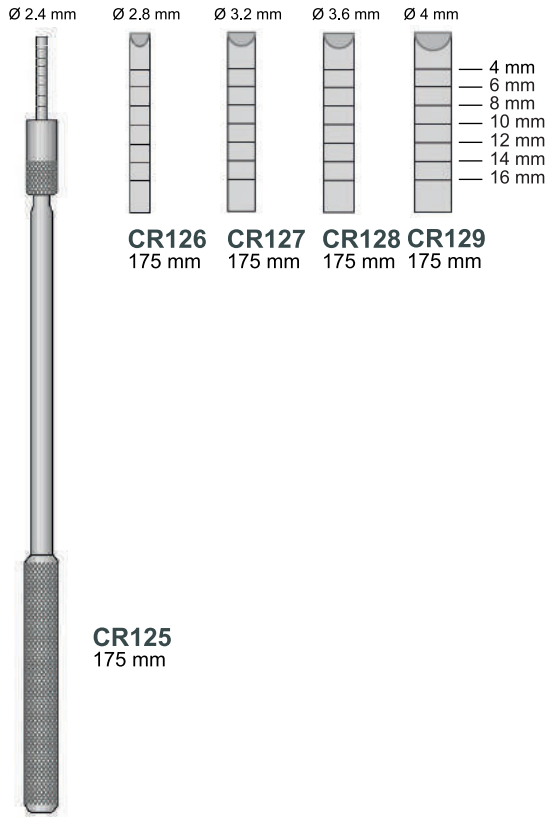

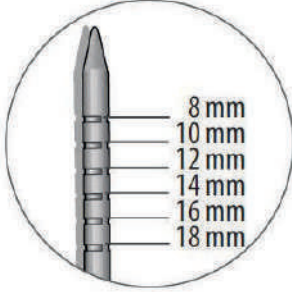

Kanal
Geniřletici
Alet /
Dilator

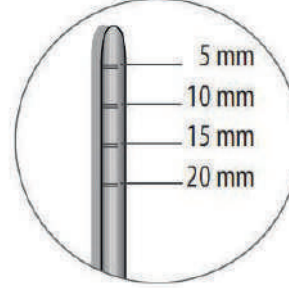

Yayıncı
Alet /
Spreader

Int.
Ext.

Konveks Tip
Convex Tip

A - Tip

B - Tip

Ø 2 mm

Ø 3 mm

Ø 3.3 mm

Ø 4 mm

Ø 3 mm

Ø 4 mm

Ø 5 mm



CR144
145 mm



CR145
145 mm



CR146
145 mm



CR147
145 mm



CR148
145 mm



CR149
145 mm



CR150
145 mm

**Doku için
For Tissue
Dişsiz
Non Serrated**

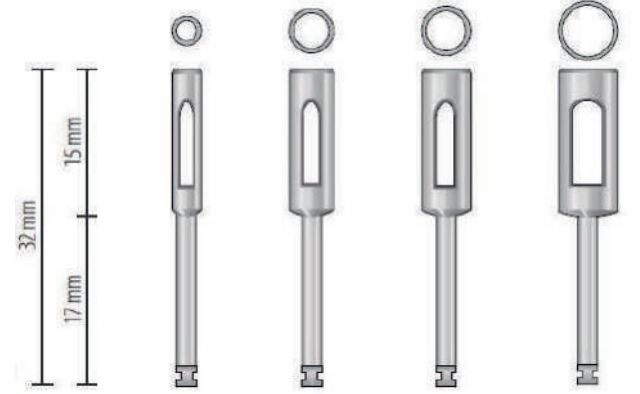

Ø mm	CR151	CR152	CR153	CR154
Int.	2.5	4.0	4.5	5.5
Ext.	3.0	4.5	5.0	6.0

**Kemik için
For Bone
Dişli
Serrated**

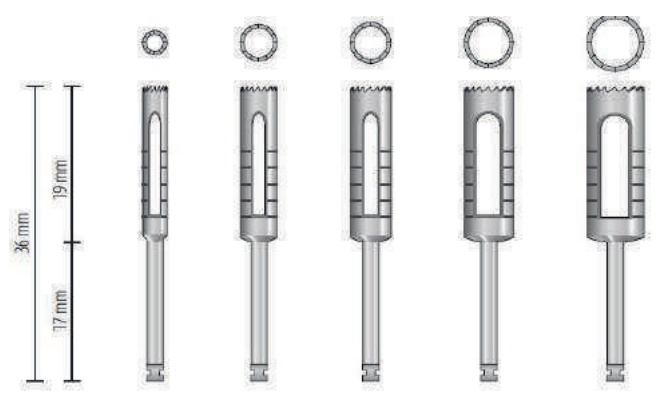

Ø mm	CR155	CR156	CR157	CR158	CR159
Int.	2.5	4.0	4.5	5.5	6.5
Ext.	3.0	4.5	5.0	6.0	7.0

**Doku Pançları
Tissue Punches**

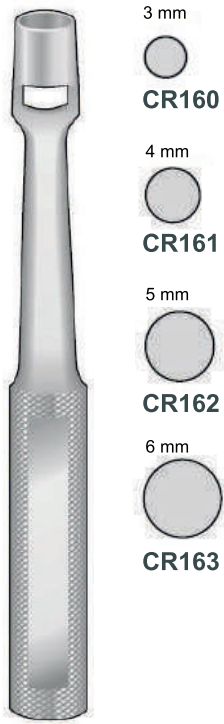

KEYES
100 mm



KEYES
90 mm

**İmplant Derinlik Ölçer
Implant depth gauge with ball end**

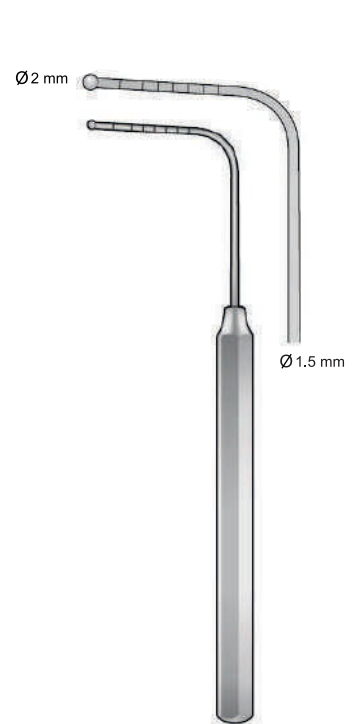

CR169
100mm

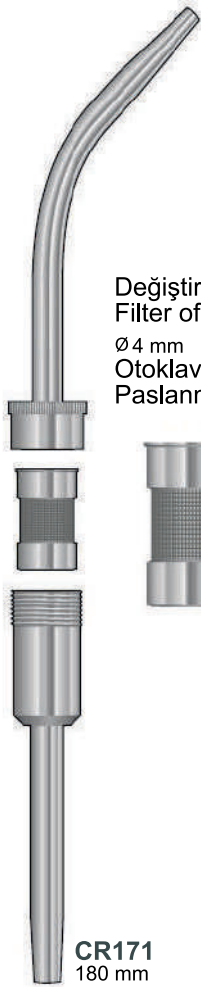
Kemik Yuvası
Bone WellPaslanmaz Çelik
Stainless SteelCR170
35 mmDeğişirme Filtresi
Filter of replacement
Ø4 mm
Otoklavlanabilir
Paslanmaz ÇelikCR171
180 mmCR172
185 mmLUNIATSCHEK
CR173
170 mmCR174
180 mm

Ø int. 2.5 mm
Ø ext. 3.5 mm

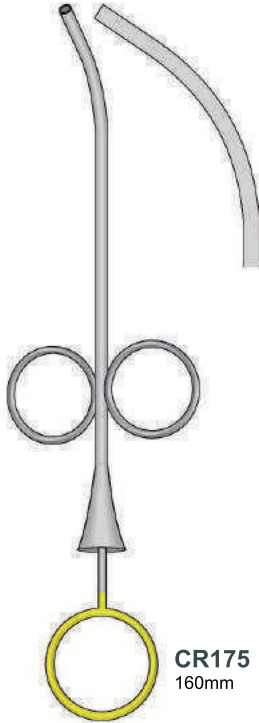

CR175
160mm

Ø int. 3.5 mm
Ø ext. 4.5 mm



CR176
160mm

Ø int. 4.4 mm
Ø ext. 5.5 mm

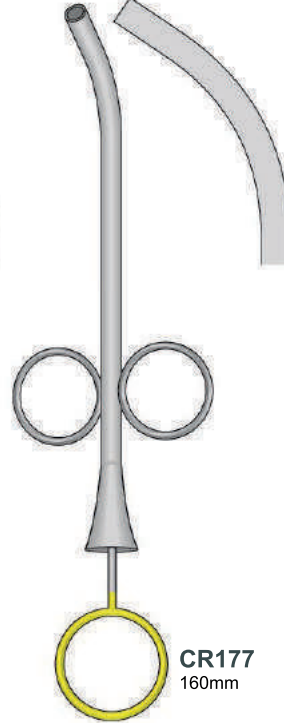

CR177
160mm

Ø int. 6 mm
Ø ext. 7 mm

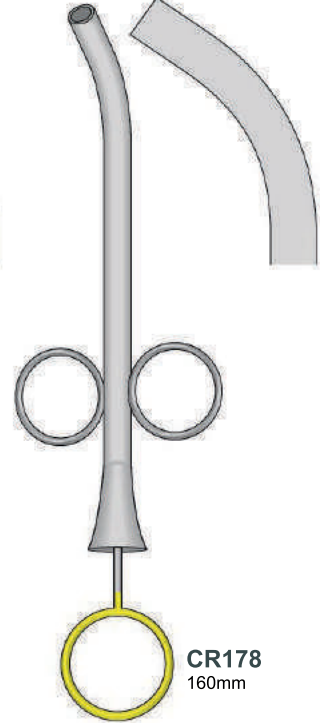

CR178
160mm



CR179
Alt / Titanium
Lower / Titanium



CR180
Üst / Titanium
Upper / Titanium



CR181
Sap / Vidalı
Handle / With screw

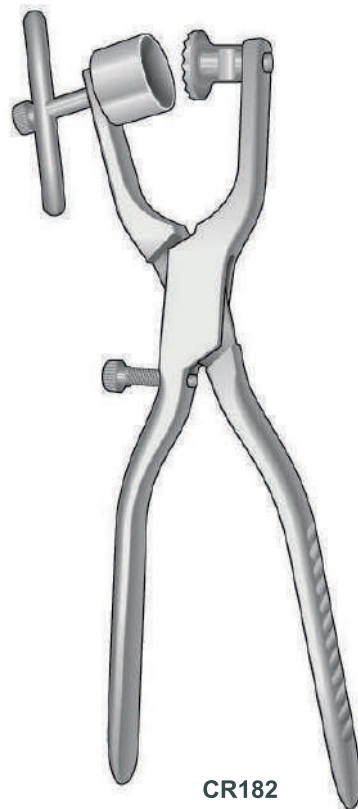

CR182

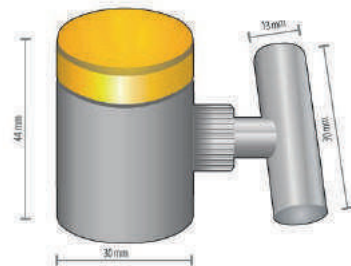

CR183
SMALL

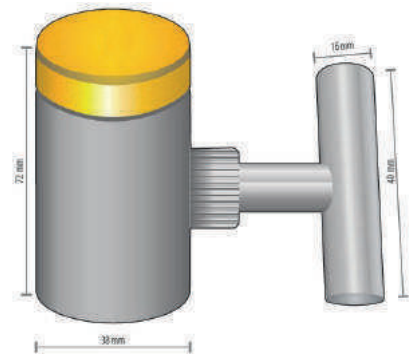

CR184
LARGE

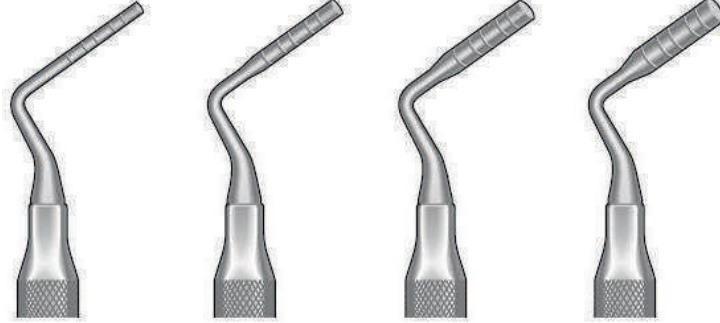

**Dişsiz Tip
Non Serrated**

**Dişli Tip
Serrated**

CR185	Ø 1.8	Ø 2.8	CR189	Ø 1.8	Ø 2.8
CR186	Ø 3.2	Ø 3.8	CR190	Ø 3.2	Ø 3.8
CR187	Ø 4.2	Ø 4.8	CR191	Ø 4.2	Ø 4.8
CR188	Ø 5.0	Ø 5.8	CR192	Ø 5.0	Ø 5.5

Ø 3.0 mm



CR193
155 mm

Ø 5.0 mm



CR194
155 mm

Ø 4.0 mm



CR195
155 mm

Ø 3.0 mm



CR196
155 mm

Ø 5.0 mm



CR197
155 mm

3 mm



CR198
170 mm

6 mm



CR199
170 mm

**İç Ölçüm
Misura interna**

- CR200 Ø 3 mm
- CR201 Ø 4 mm
- CR202 Ø 5 mm

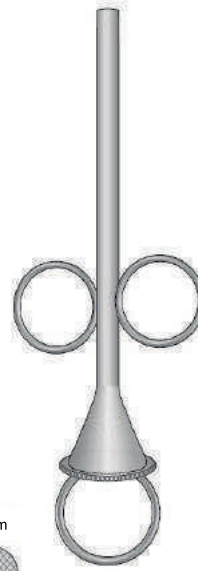

FOITZIK
140 mm

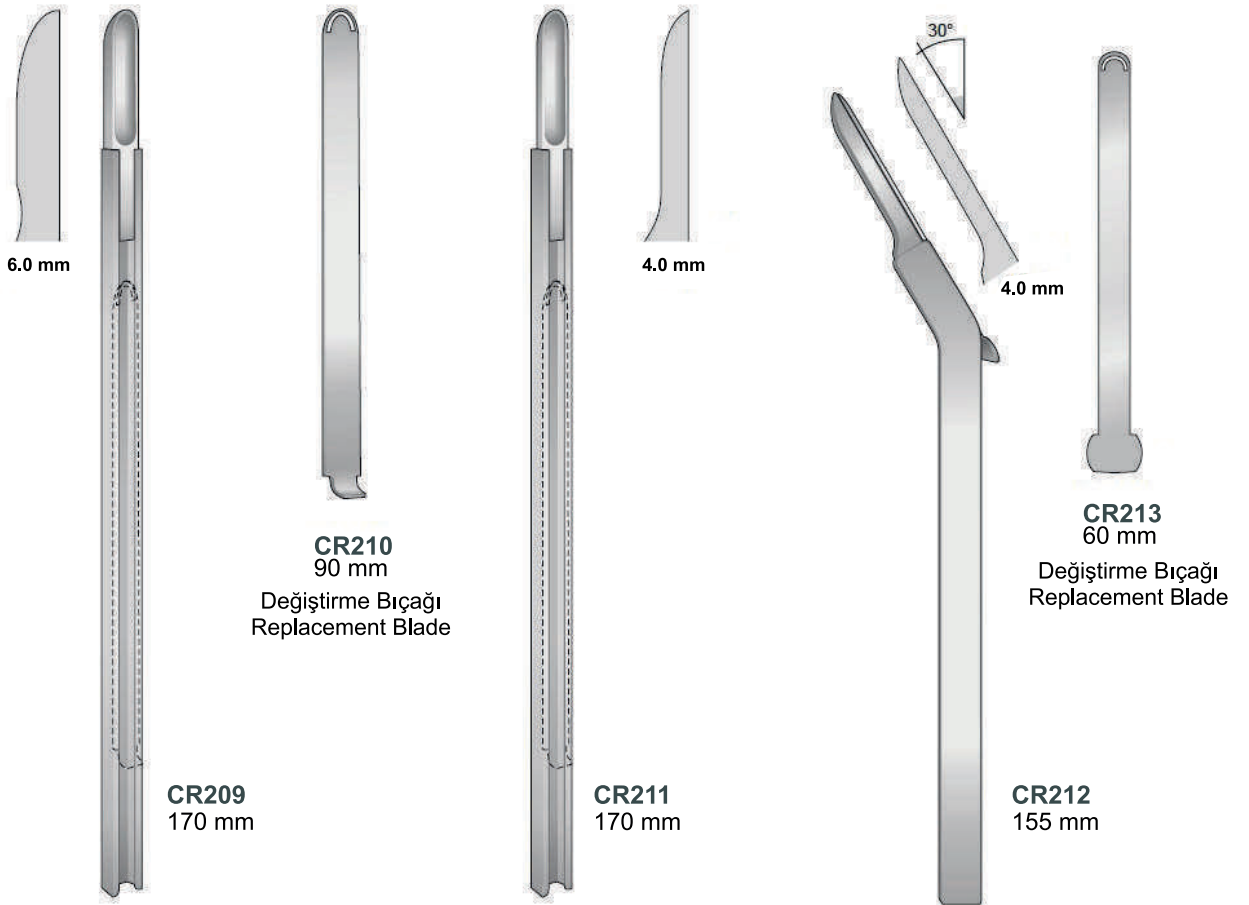
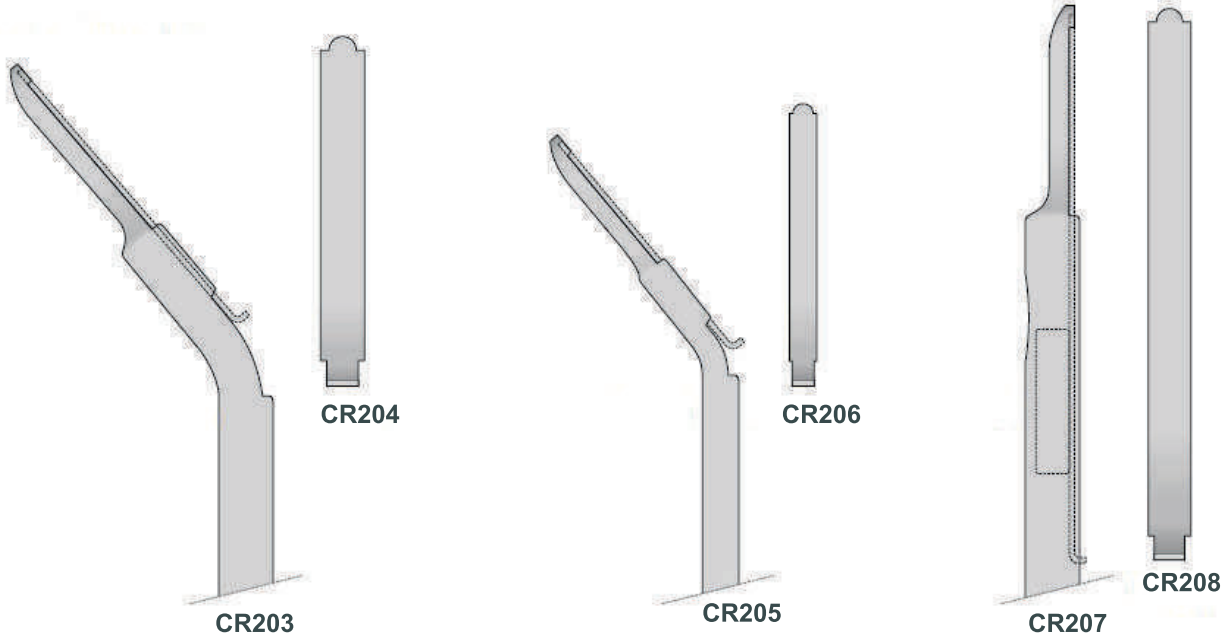

Ölçüm Aralığı: 0 - 20 mm
Measuring range : 0 - 20 mm

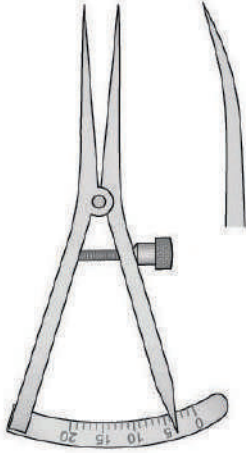

CASTROVIEJO
CR214
90 mm



CR215
100 mm



CR216
200 mm



CR217
125 mm



CR218
95 mm

Ölçüm Aralığı: 0 - 40 mm
Measuring range : 0 - 40 mm

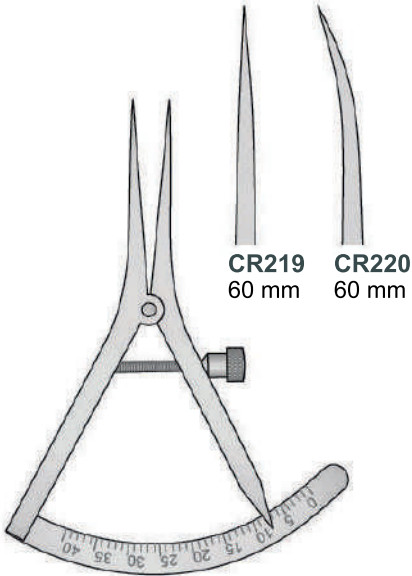

CASTROVIEJO
90 mm

CR219
60 mm

CR220
60 mm

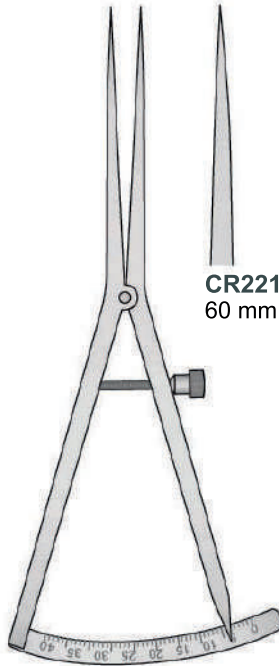

CASTROVIEJO
170 mm

CR221
60 mm

CR222
60 mm

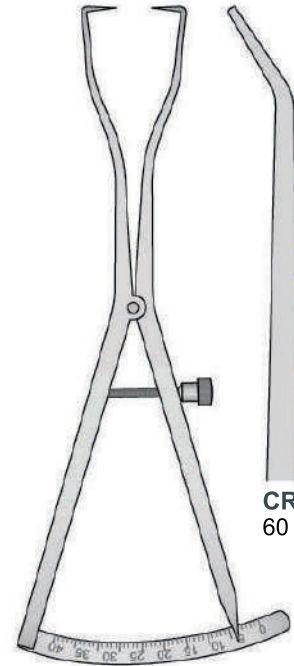

CASTROVIEJO
170 mm

CR223
60 mm

ÜÇ BOYUTLU İMPLANTOLOJİ KALİPERİ

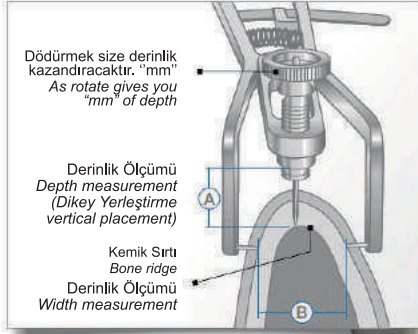

CR224

Implantoloji Kalibre Üç Boyutlu
Implantology Calliper Tridimensional

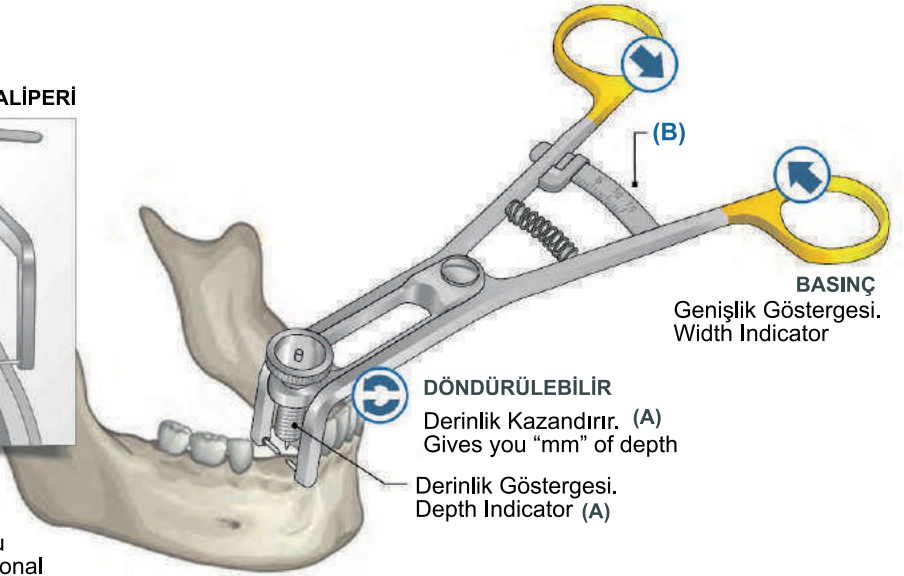
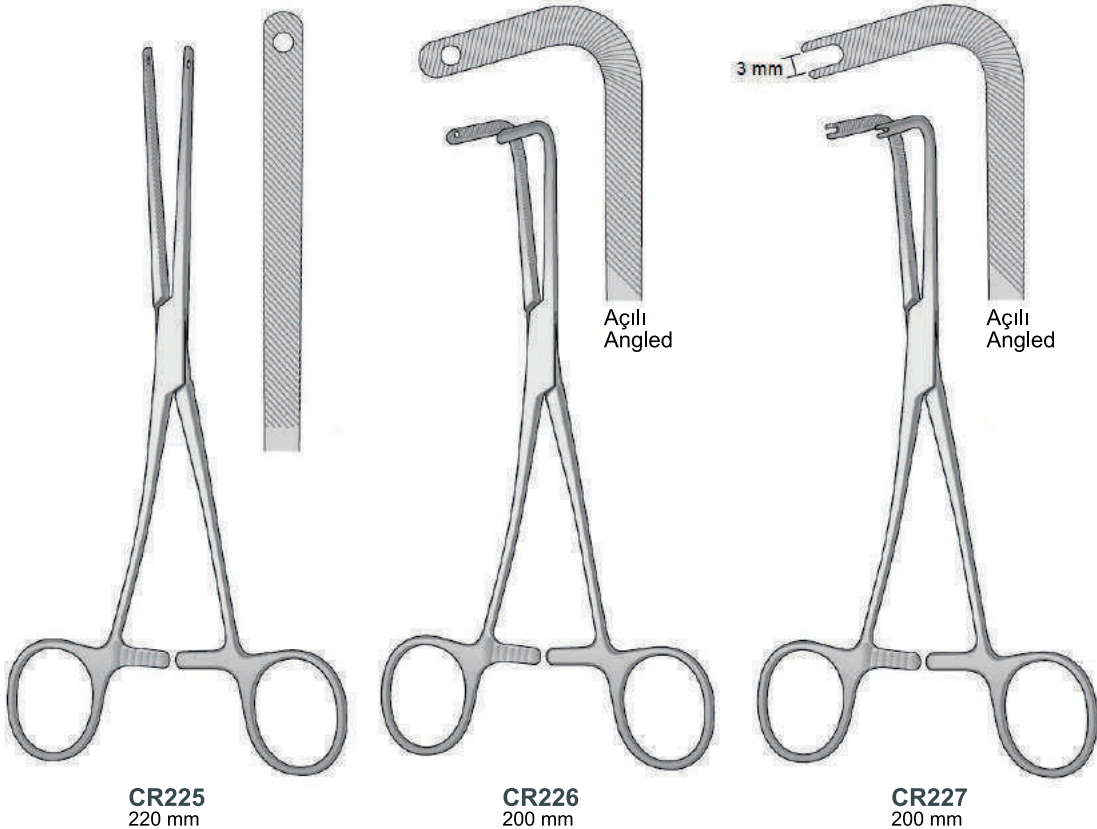
Kemik Tutma Kelepçeleri
Bone Holding Clamps

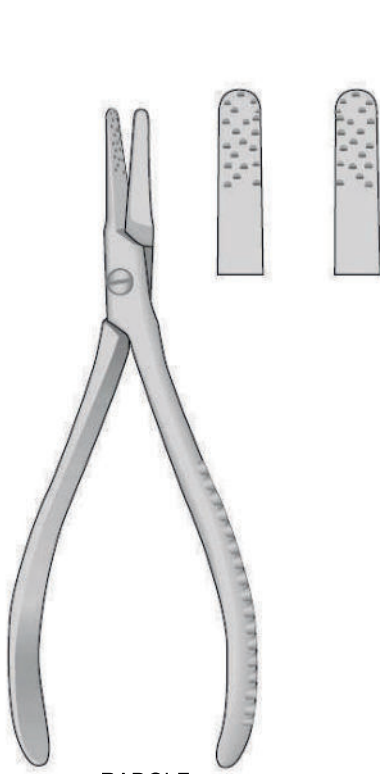

**RADOLF
CR228**
135 mm

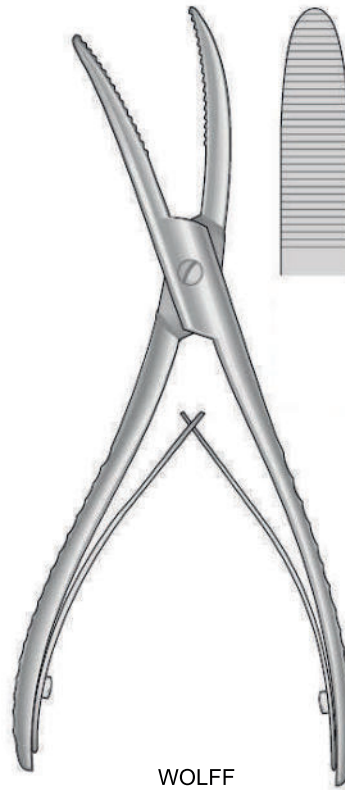

**WOLFF
CR229**
180 mm

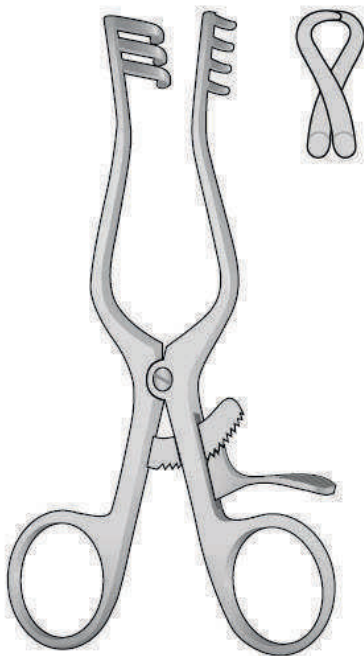

**WEITLANER
CR230**
165 mm

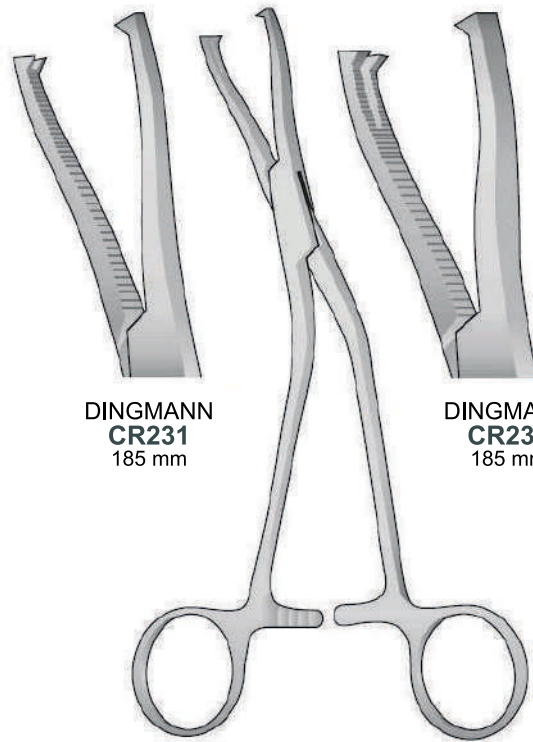

**DINGMANN
CR231**
185 mm

**DINGMANN
CR232**
185 mm

DINGMANN
185 mm

CR233
100 mm



CR234
130 mm



CR235
150 mm



CR236
150 mm



CR237



CR238
145 mm



CR239



CR240



CR241



CR242



CR243
155 mm



ASPIRATÖR UÇLARI

Ø 2.0 mm

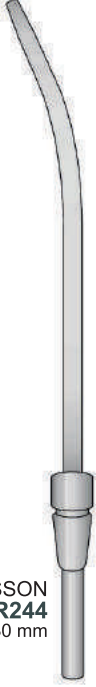
MC. KESSON
CR244
180 mm

Ø 3.0 mm

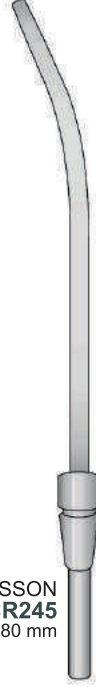
MC. KESSON
CR245
180 mm

Ø 4.0 mm

MC. KESSON
CR246
180 mm

Ø 4.0 mm

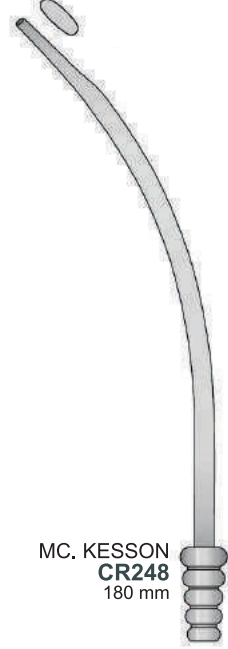
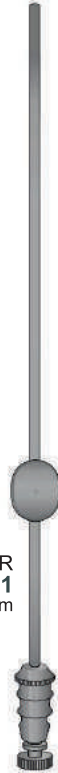
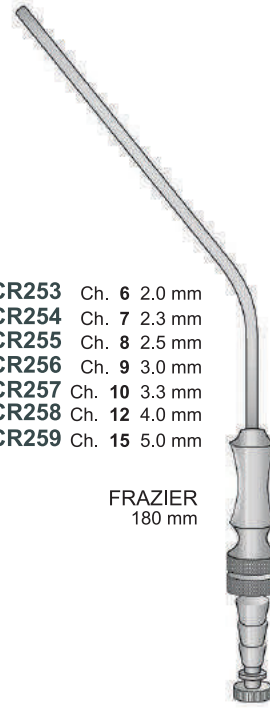
MC. KESSON
CR247
180 mmMC. KESSON
CR248
180 mmYANKAUER
CR249
310 mmYANKAUER
CR250
310 mmYANKAUER
CR251
310 mmYANKAUER
CR252
310 mm

CR253	Ch. 6	2.0 mm
CR254	Ch. 7	2.3 mm
CR255	Ch. 8	2.5 mm
CR256	Ch. 9	3.0 mm
CR257	Ch. 10	3.3 mm
CR258	Ch. 12	4.0 mm
CR259	Ch. 15	5.0 mm

FRAZIER
180 mm

ASPIRATÖR UÇLARI

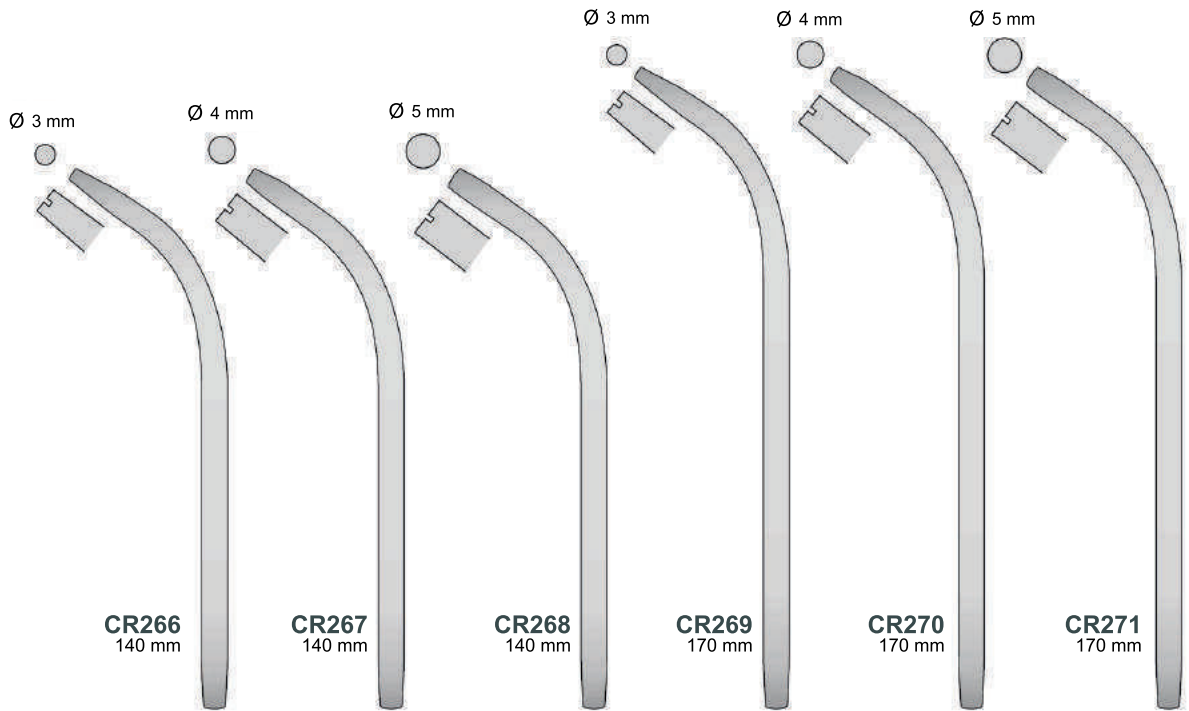
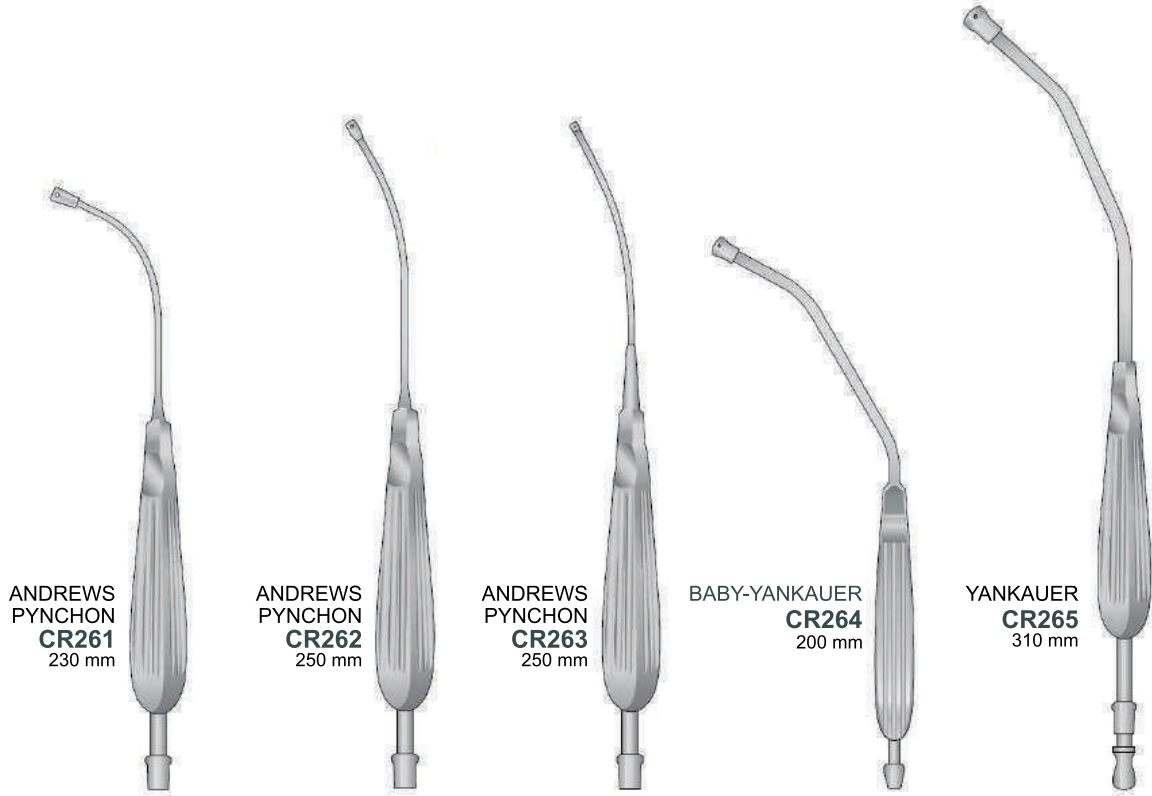

KARPÜL TABANCASI

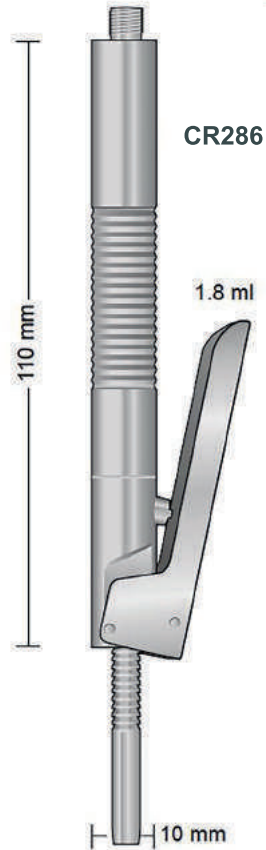
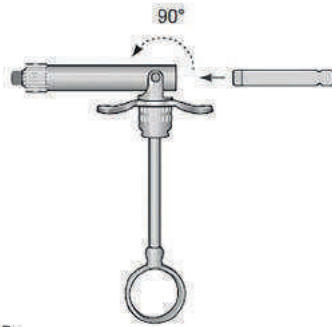
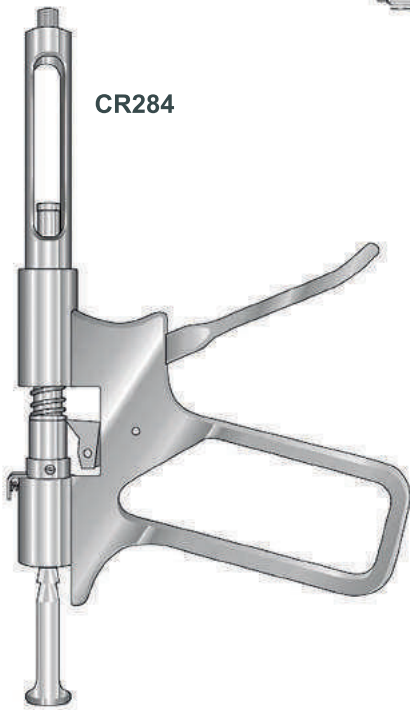
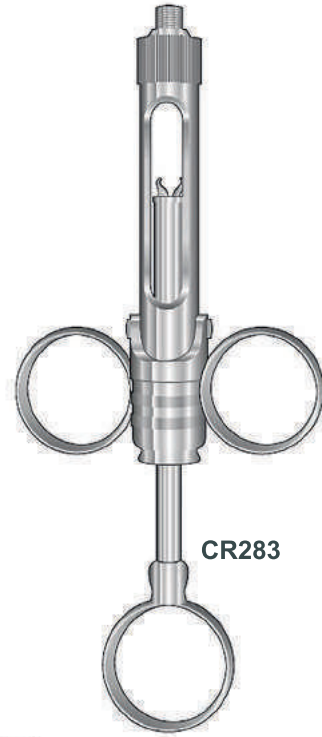
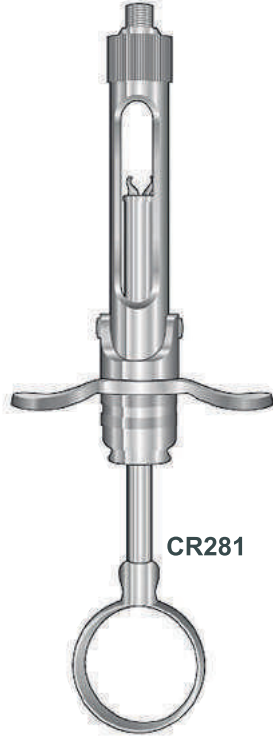
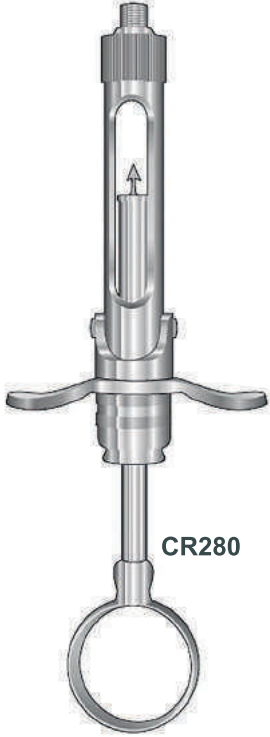



ÇENE CERRAHİSİ MAXILLOFACIAL SURGERY

Ağız Diş ve Çene Cerrahisi, bütün yaş aralığındaki bireylerin ağız, diş ve çene bölgelerindeki sert ve yumuşak dokuların hastalıkları, yaralanmaları ve bozukluklarının düzeltilmesi için gerekli tanı ve tedavi yöntemlerini uygulayan Anabilim Dalı'dır.

Oral and Maxillofacial Surgery is the Department that applies the necessary diagnostic and treatment methods to correct the diseases, injuries and disorders of the hard and soft tissues in the mouth, teeth and jaw areas of individuals of all ages.



ERSOY
DENTAL

ODC
CERRAHI ALETLER



ADAMS
MS001
500 mm



LANGENBECK
MS002
Ø 26 / 20 mm



MAUNDER
MS003
95 mm



PİTHA
MS004
28x30 mm

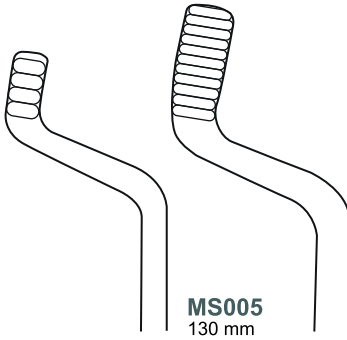

MS005
130 mm

MS006
130 mm



ROSER-KÖNIG
130 mm



HEİSTER
MS007
130 mm



DENHARDT
MS008
130 mm

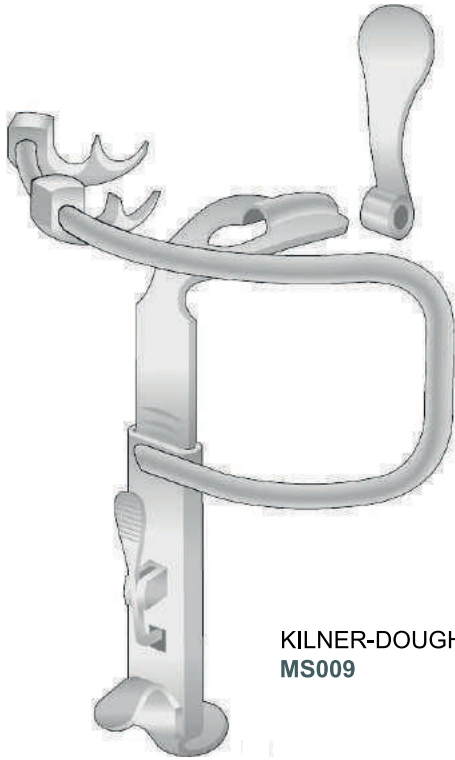

KILNER-DOUGHTY
MS009



Fig.1
MS010
68x30 mm



Fig.2
MS011
77x34 mm



Fig.3
MS012
82x39 mm

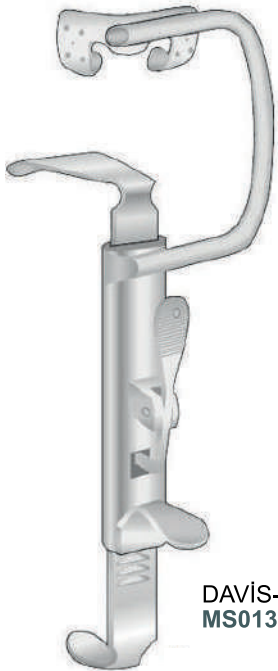

DAVIS-BOYLE
MS013

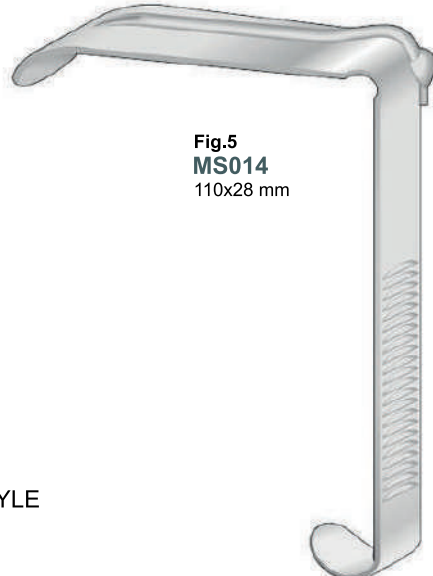

Fig.5
MS014
110x28 mm

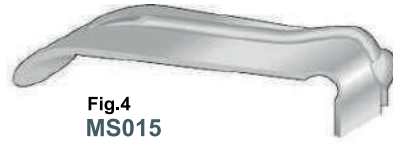

Fig.4
MS015
95x27 mm



Fig.3
MS016
80x27 mm



Fig.2
MS017
65x26 mm



Fig.1
MS018
30x20 mm



Fig.3
MS020
100x25 mm

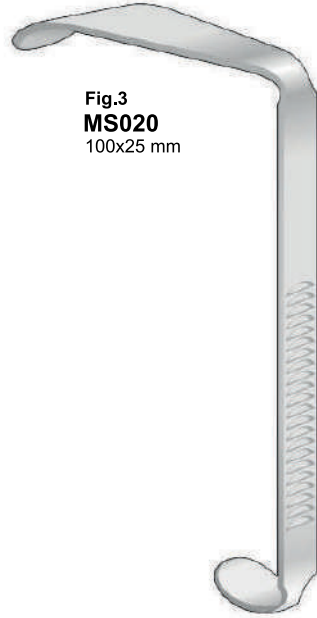

Fig.2
MS021
85x25 mm



Fig.1
MS022
75x25 mm

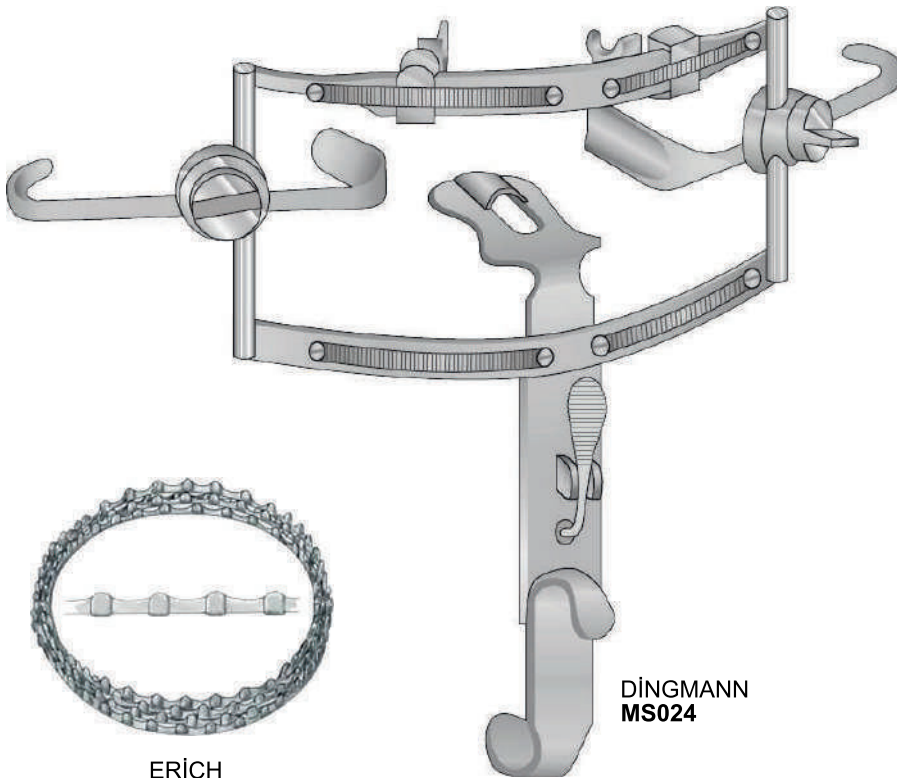

Fig.1
MS025
62x26 mm

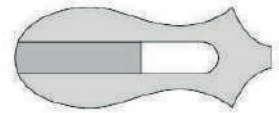

Fig.2
MS026
65x30 mm

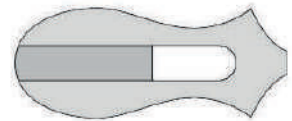
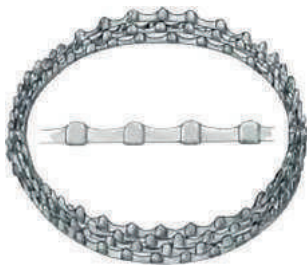
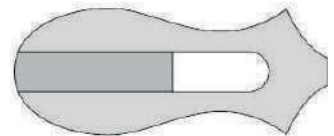

Fig.3
MS027
78x32 mm



ERICH
MS023



MARTÍN-SIMPLEX
MS028
105 mm



CAWOOD
MINNESOTA
MS029
145 mm



MS030
19 mm
150 mm
Wood



MS031
15 mm
150 mm



DOYEN

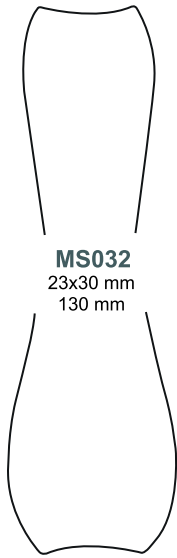

MS032
23x30 mm
130 mm

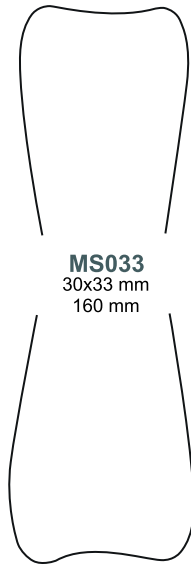

MS033
30x33 mm
160 mm



OBWEGESER
MS034
12 mm

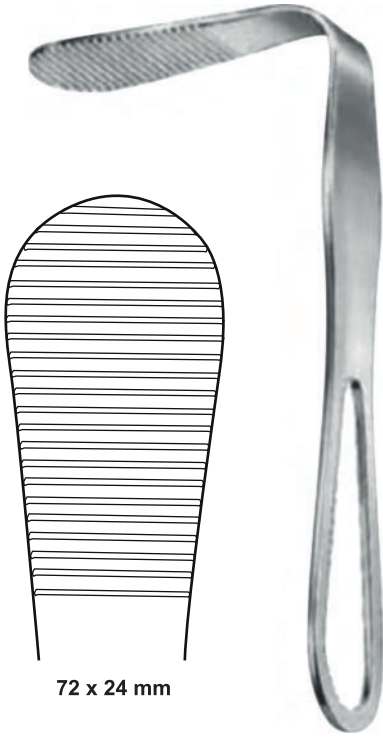

HARTMANN
MS035
150 mm

72 x 24 mm

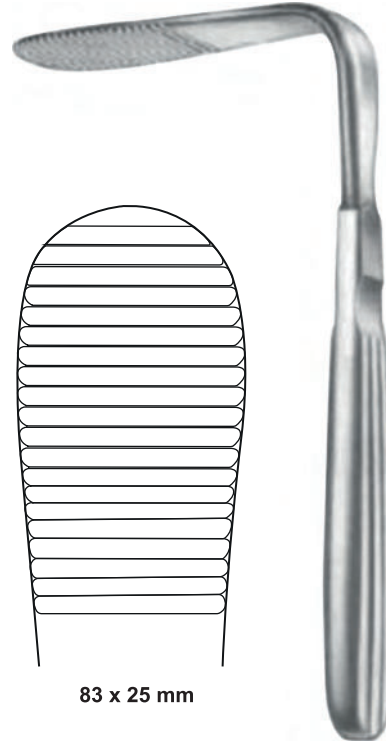

TOBOLD
MS036
150 mm

83 x 25 mm

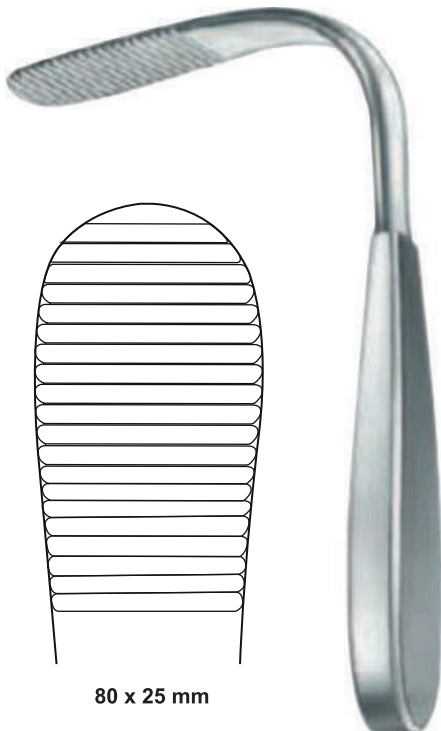

TOBOLD
MS037
160 mm

80 x 25 mm

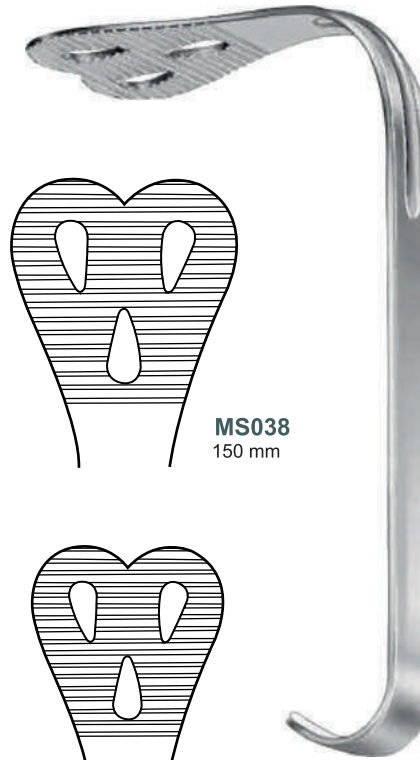

MS038
150 mm

WIEDER
150 mm

MS039
140 mm



MS040
230 mm

MS041
210 mm

MS042
210 mm

MS043
250 mm

**ECKELT
MS044**
210 mm

**ECKELT
MS045**
210 mm

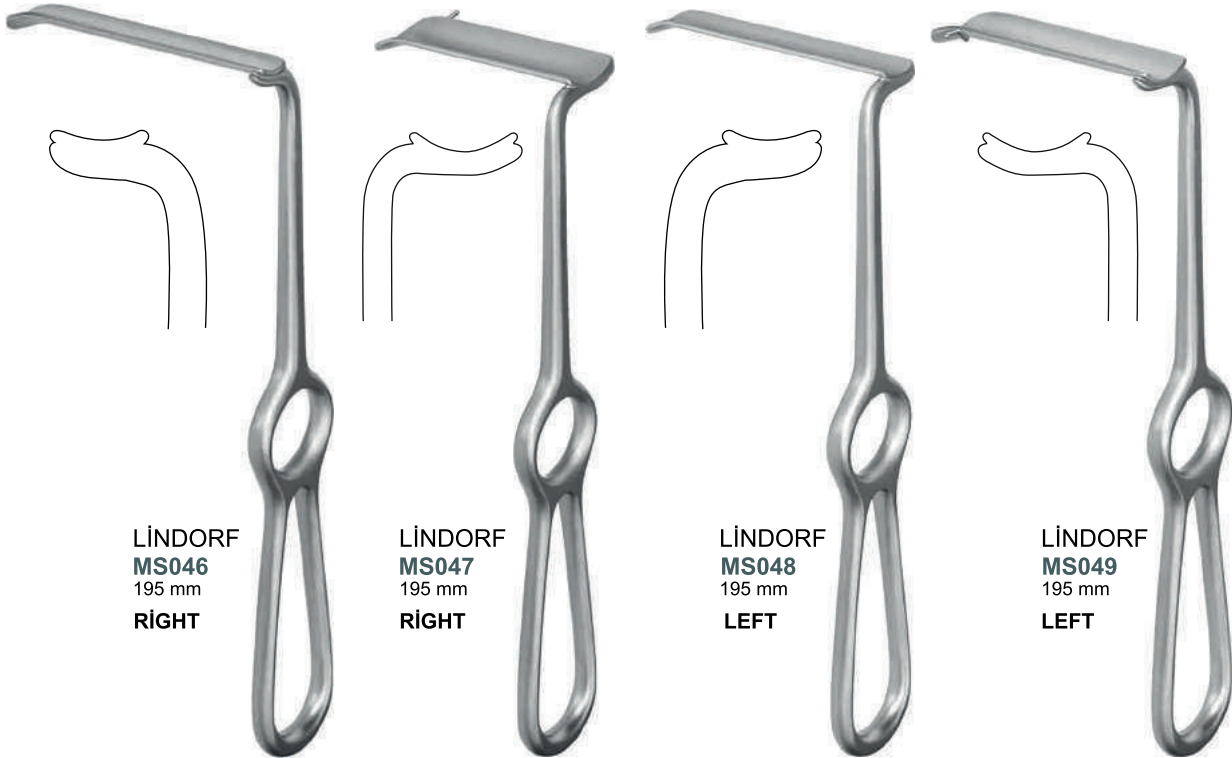

**LİNDORF
MS046**
195 mm
RIGHT

**LİNDORF
MS047**
195 mm
RIGHT

**LİNDORF
MS048**
195 mm
LEFT

**LİNDORF
MS049**
195 mm
LEFT



**SCHUCHARDT
MS050**
180 mm

**METZ
MS051**
195 mm

**SCHUCHARDT
MS052**
180 mm

**METZ LAUER
MS053**
195 mm

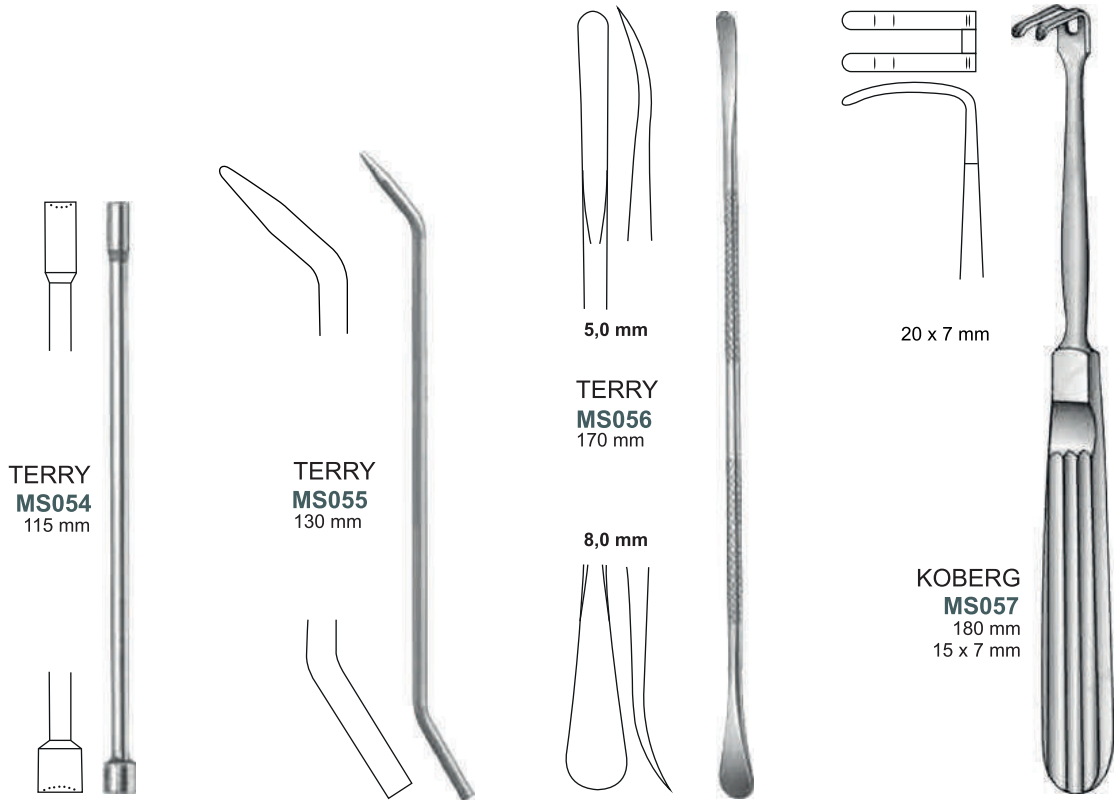

**TERRY
MS054**
115 mm

**TERRY
MS055**
130 mm

5,0 mm

**TERRY
MS056**
170 mm

8,0 mm

20 x 7 mm

**KOBERG
MS057**
180 mm
15 x 7 mm

OBWEGESER



MS058
175 mm
Periost Elevatör
Periosteal Elevator

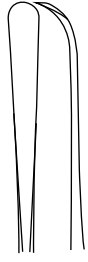

MS059
175 mm
Periost Elevatör
Periosteal Elevator

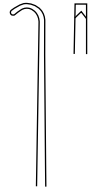

MS060

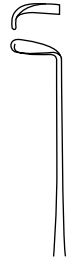

MS061

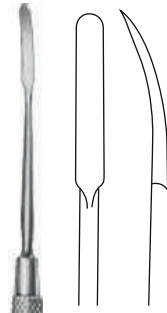

3 mm

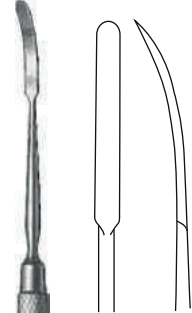

3,5 mm



MS062
180 mm



MS063
180 mm

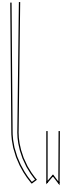

OBWEGESER



MS064
6 mm
175 mm



MS065
7 mm
175 mm



MS066
9 mm
175 mm

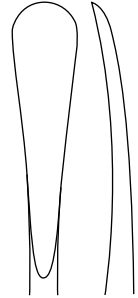

MS067
11 mm
175 mm



MS068
5 mm
200 mm



MS069
7 mm
200 mm



MS070
9 mm
200 mm



OBWEGESER



MS071
7,5 mm
175 mm



MS072
11 mm
175 mm



MS073
175 mm



MS074
175 mm



MS075
205 mm



MS076
205 mm

ROWE
190 mm



MS077
RİGH

MS078
LEFT



MS079
170 mm



DONOVAN
MS080
190 mm
16,5 mm



ROWE
MS081
150 mm

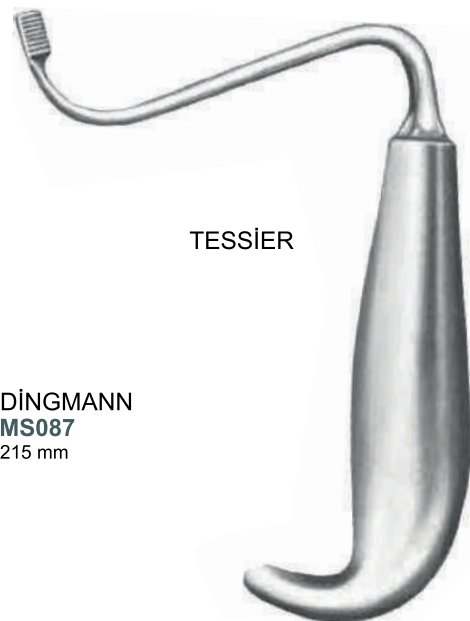
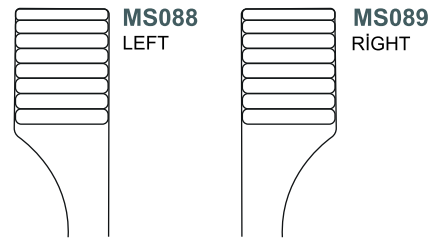
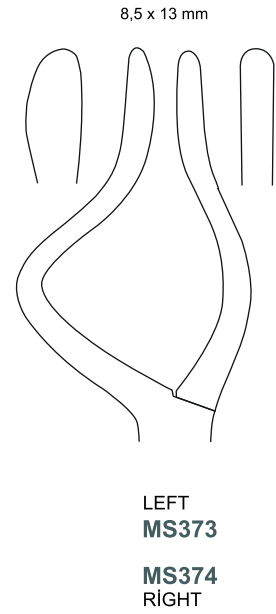
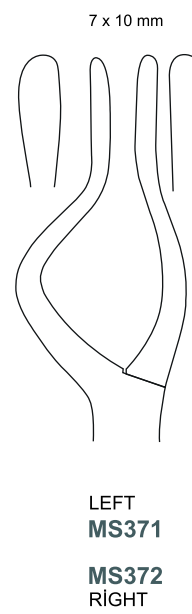
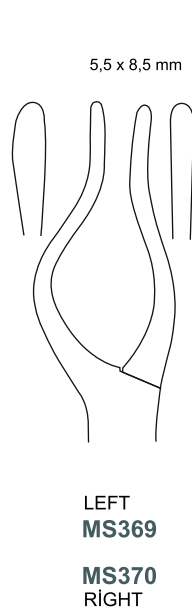
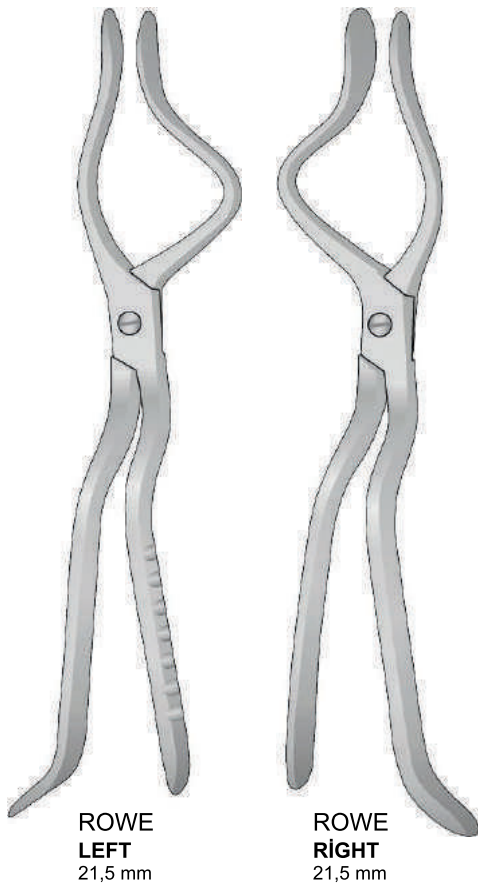

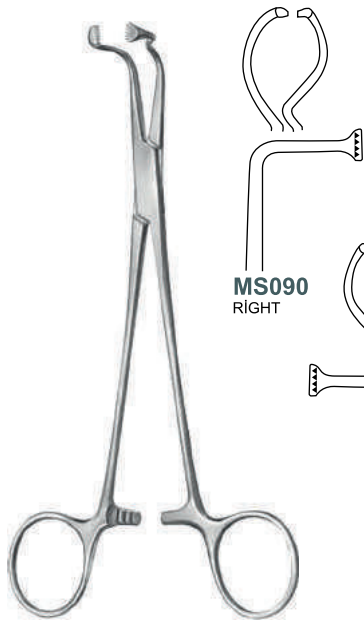

KEEN
175 mm

MS090
RIGHT



MS091
LEFT

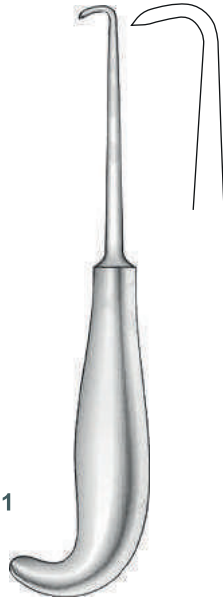

DİNGMANN-WILK
MS092
200 mm



TROCAR and DRILL GUIDE
MS093



STEINHAUSER
MS094
125 mm



STEINHAUSER
MS095
135 mm



WOLFORD
MS096
250 mm

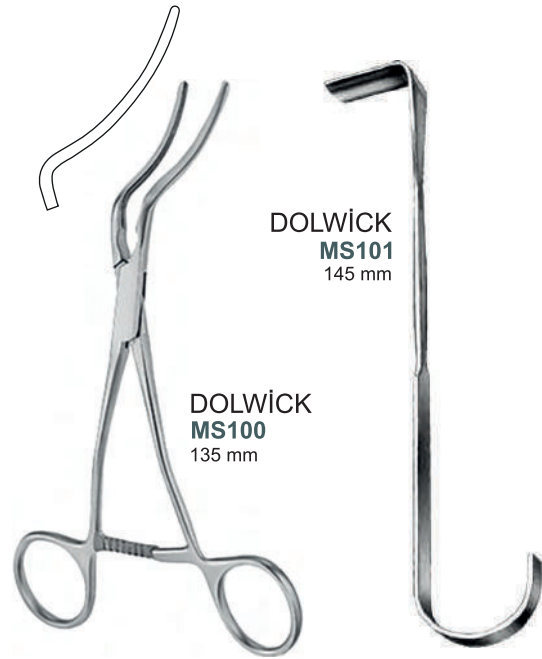

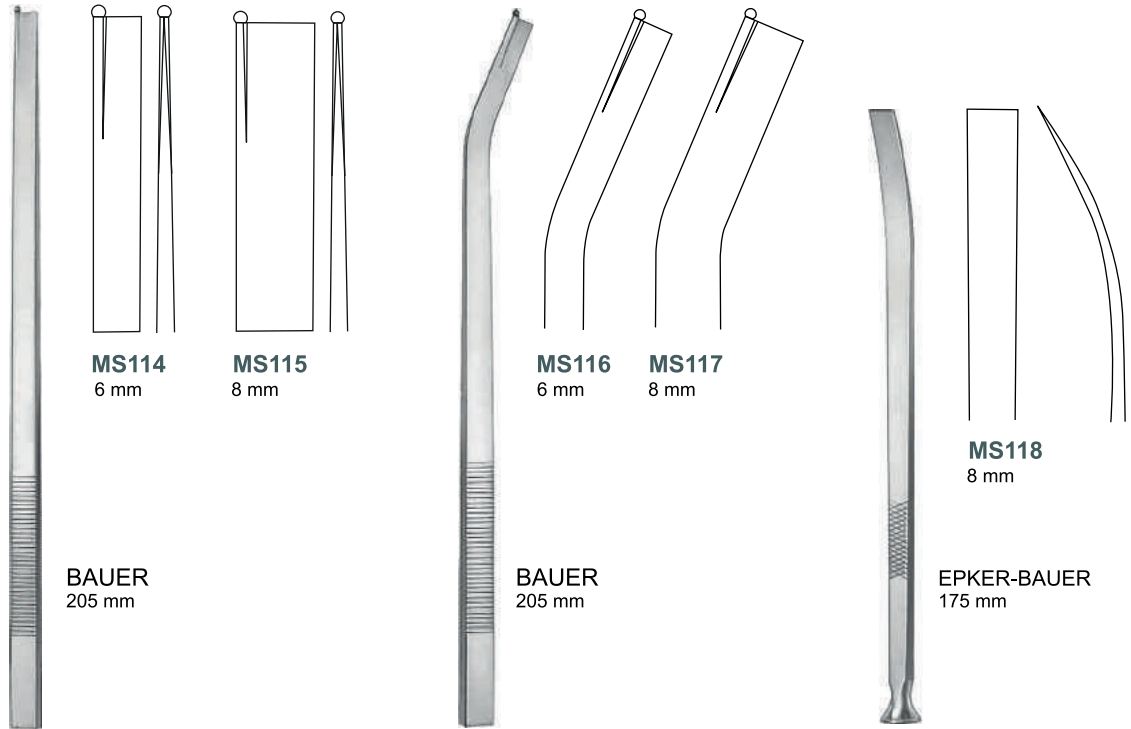
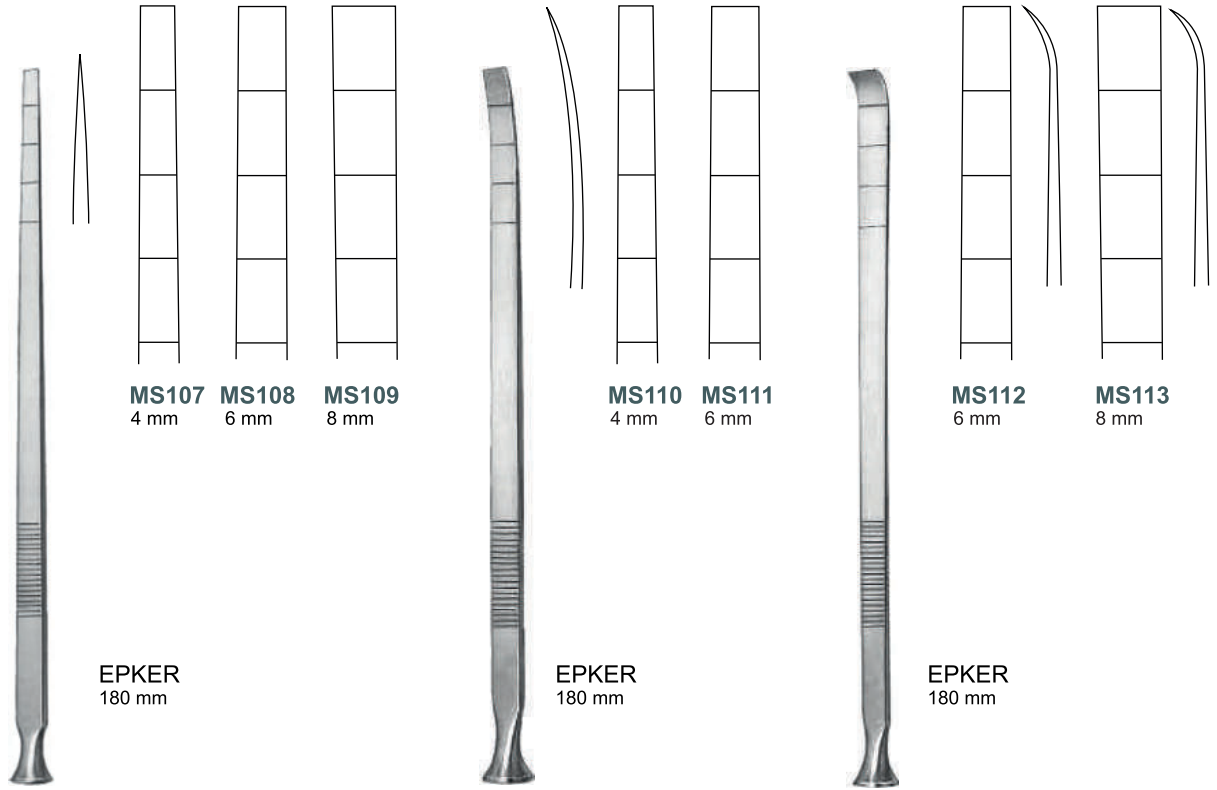

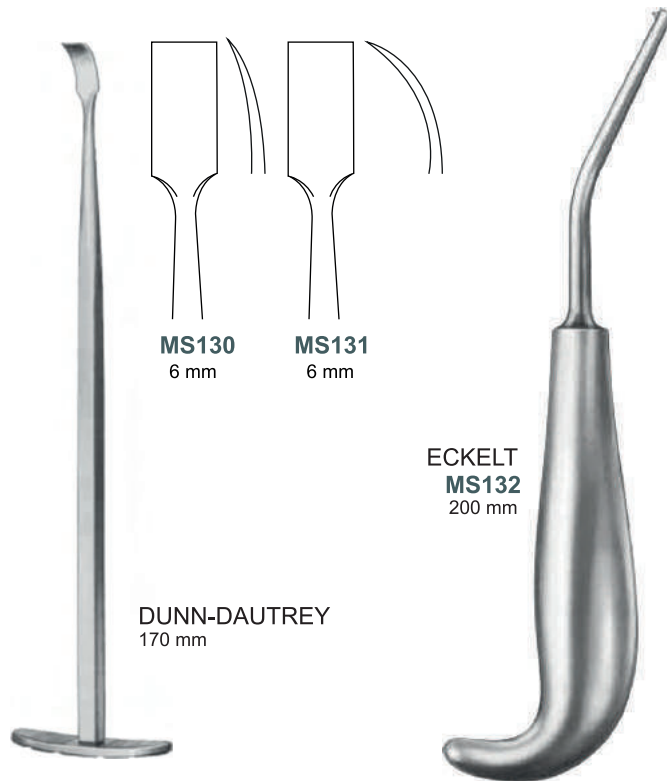
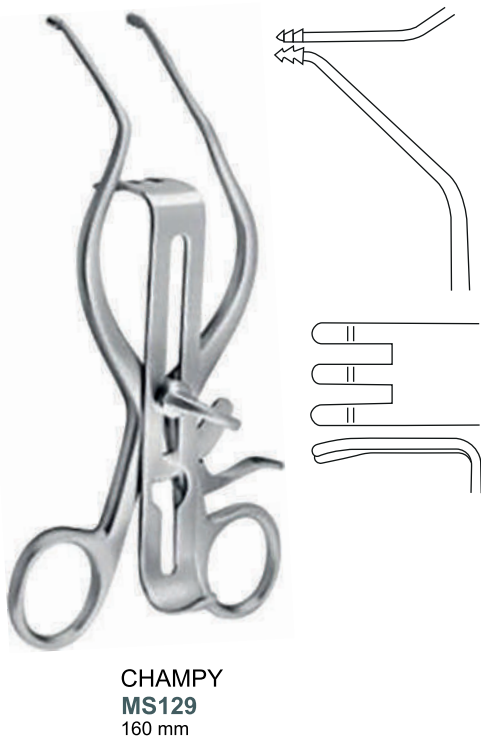
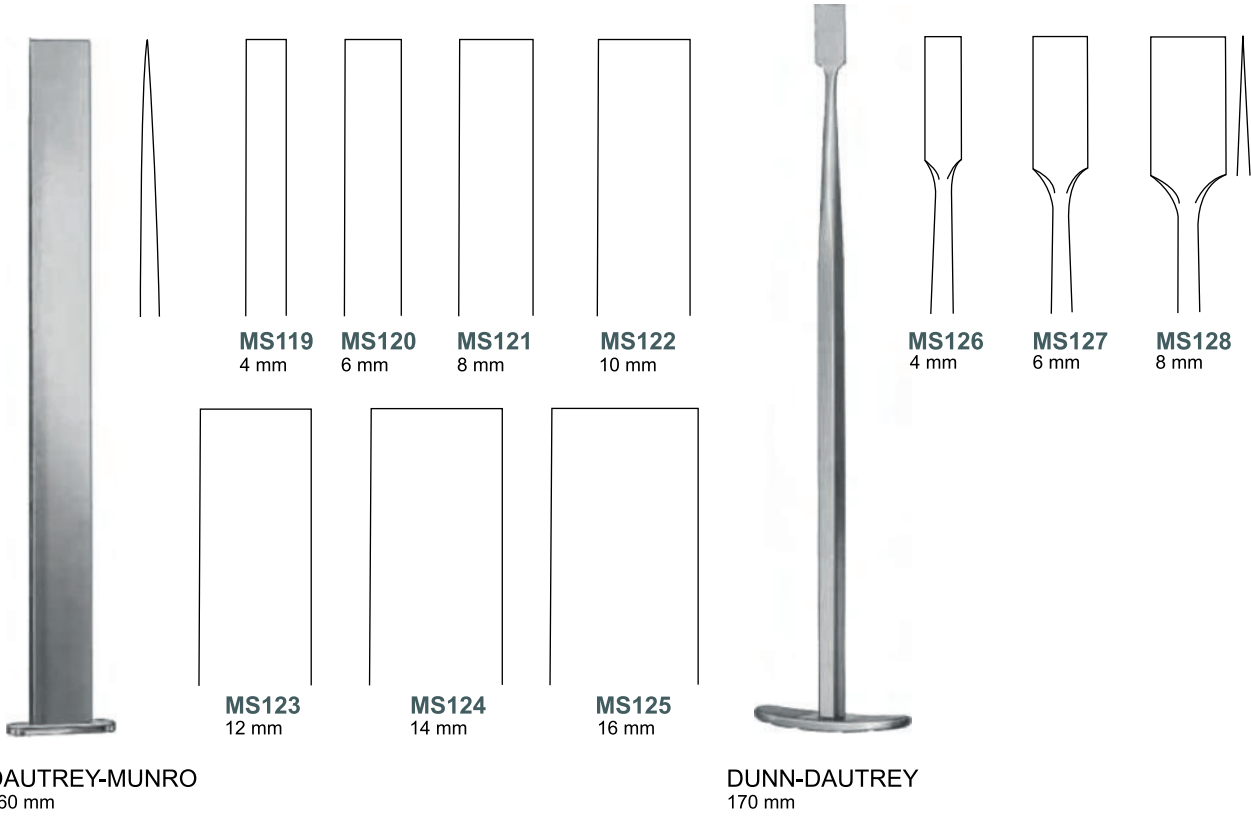

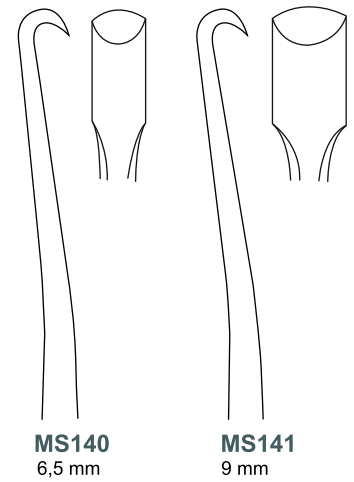
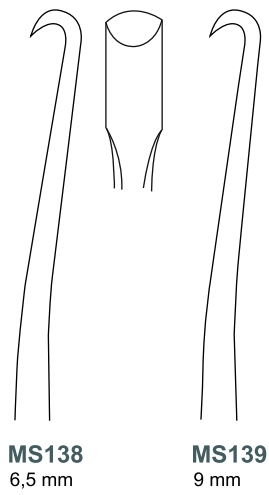
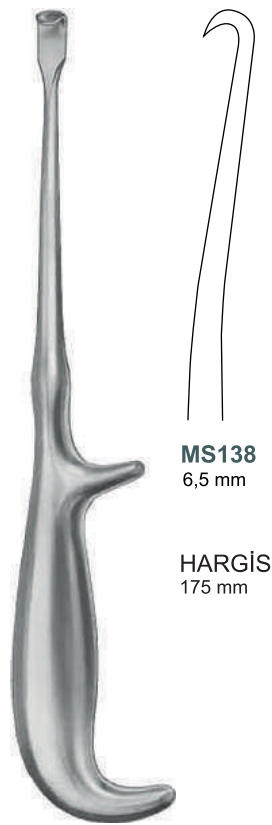
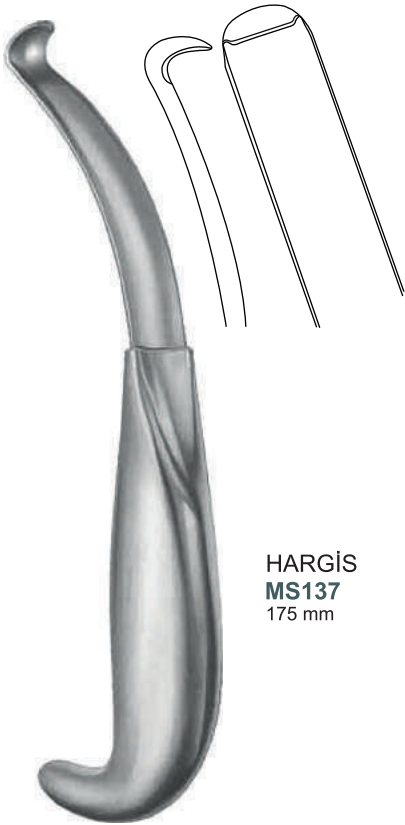
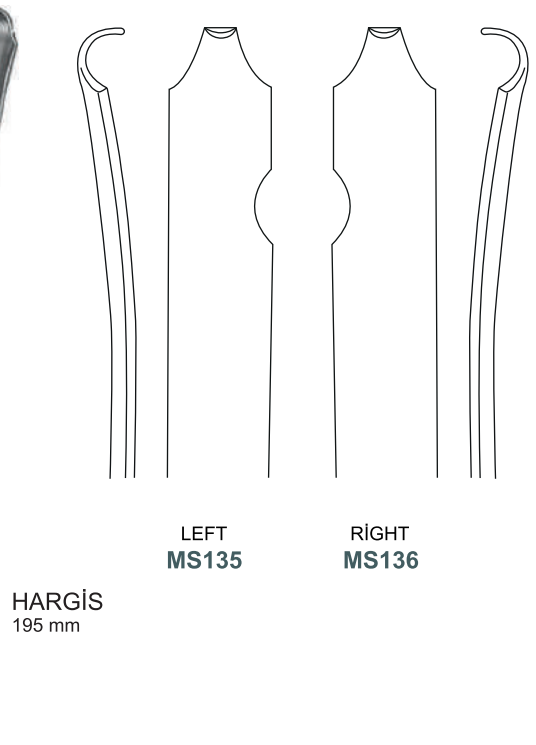
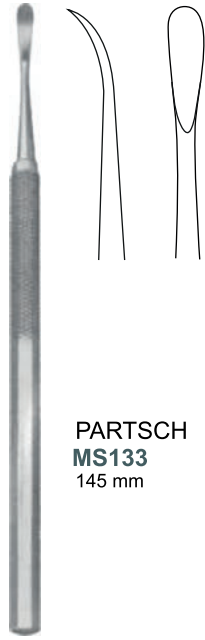



HARGİS
MS142
185 mm



HARGİS
MS143
185 mm



HARGİS
MS144
220 mm



HARGİS
MS145
220 mm



SMİTH
RIGHT
MS146
185 mm



SMİTH
LEFT
MS147
185 mm



SMİTH
MS148
235 mm



TERRY LEFT
MS149
170 mm



TERRY RIGHT
MS150
170 mm



TERRY MS151
165 mm



TERRY MS152
240 mm



TERRY MS153
170 mm



TERRY MS154
190 mm



RIGHT TERRY MS155
140 mm



LEFT TERRY MS156
140 mm



TURVEY MS157
170 mm

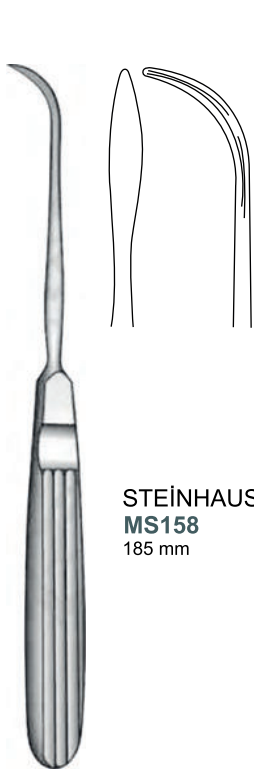

STEINHAUSER
MS158
185 mm



STEINHAUSER
MS159
270 mm

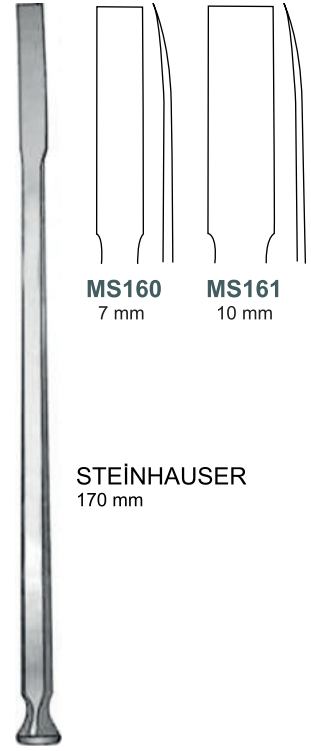

MS160
7 mm

MS161
10 mm

STEINHAUSER
170 mm

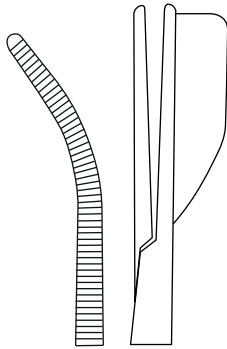

STEINHAUSER
RIGHT
MS162
160 mm

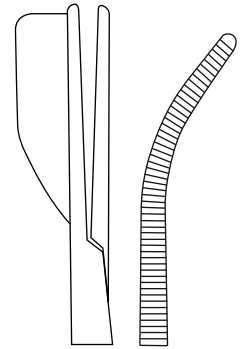

STEINHAUSER
LEFT
MS163
160 mm



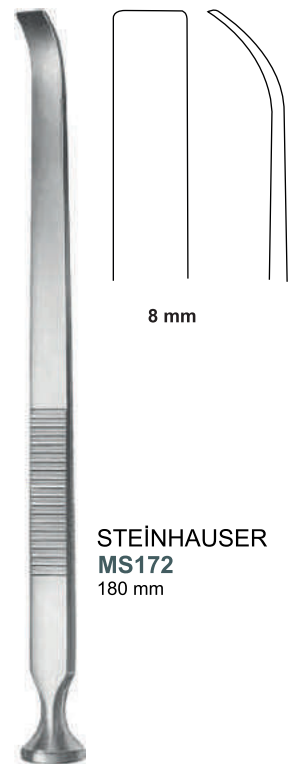
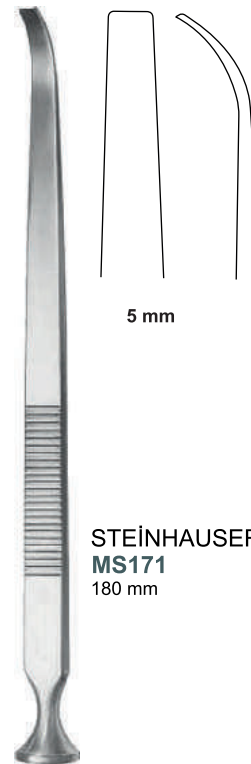
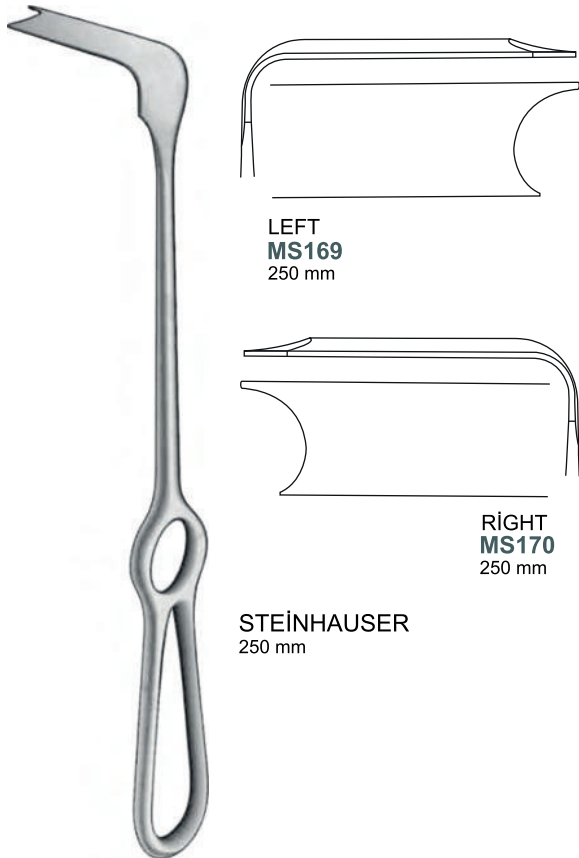
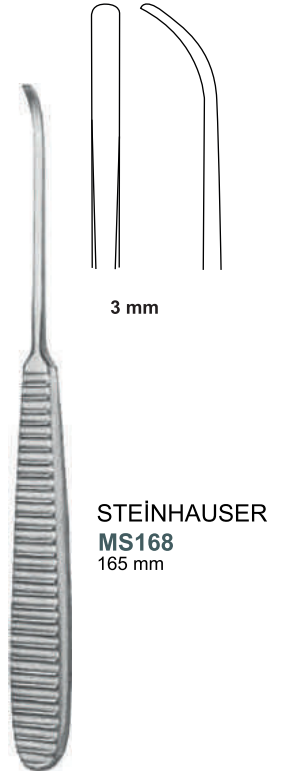
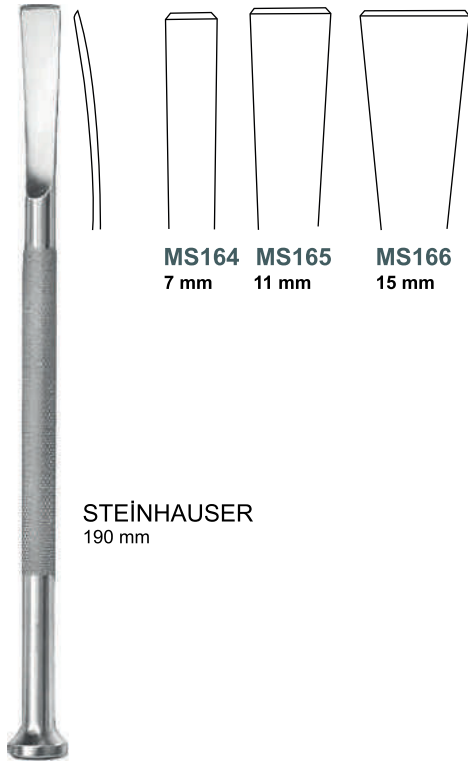



MS173
75 x 11/15 mm

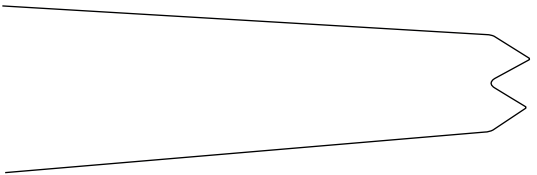

MS174
75 x 12/22 mm

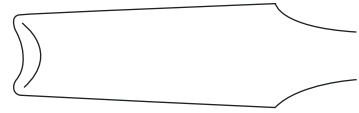

MS175
30 x 9/12 mm

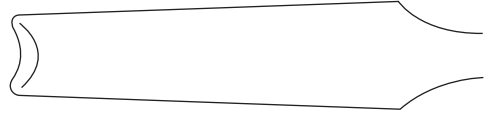

MS176
45 x 9/12 mm



MS177
60 x 9/12 mm

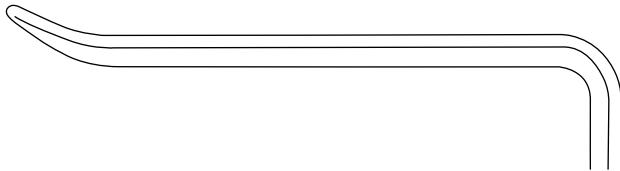

OBWEGESER
240 mm



WOLFORD
215 mm



MS178
6 mm

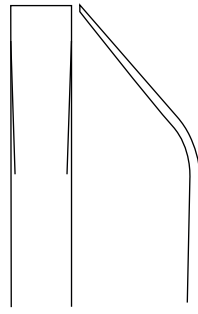

MS179
8 mm



OBWEGESER
240 mm



RIGHT
OBWEGESER
MS180
165 mm

OBWEGESER
MS181
170 mm



LEFT
OBWEGESER
MS182
165 mm

OBWEGESER
MS183
170 mm

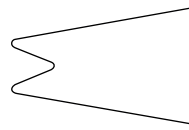

45 x 10/23 mm

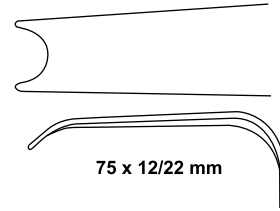

75 x 12/22 mm



OBWEGESER
180 mm



MS184
6 mm



MS185
7 mm



MS186
9 mm



MS187
11 mm



OBWEGESER
MS188
240 mm



OBWEGESER
MS189
240 mm

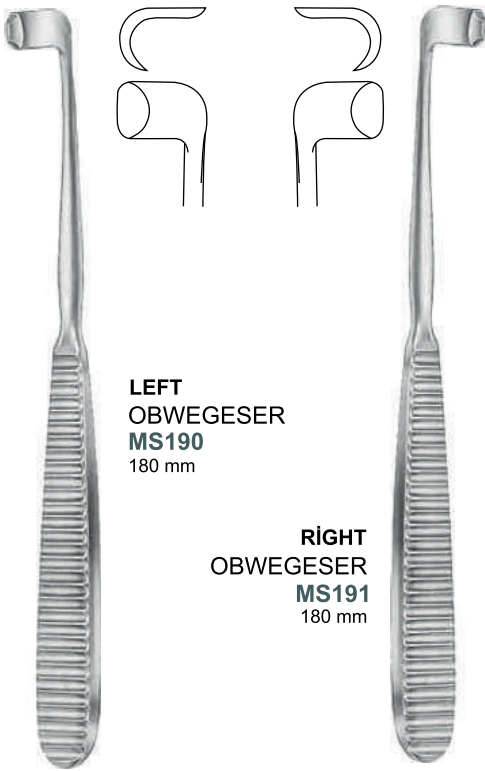

**LEFT
OBWEGESER
MS190
180 mm**

**RIGHT
OBWEGESER
MS191
180 mm**

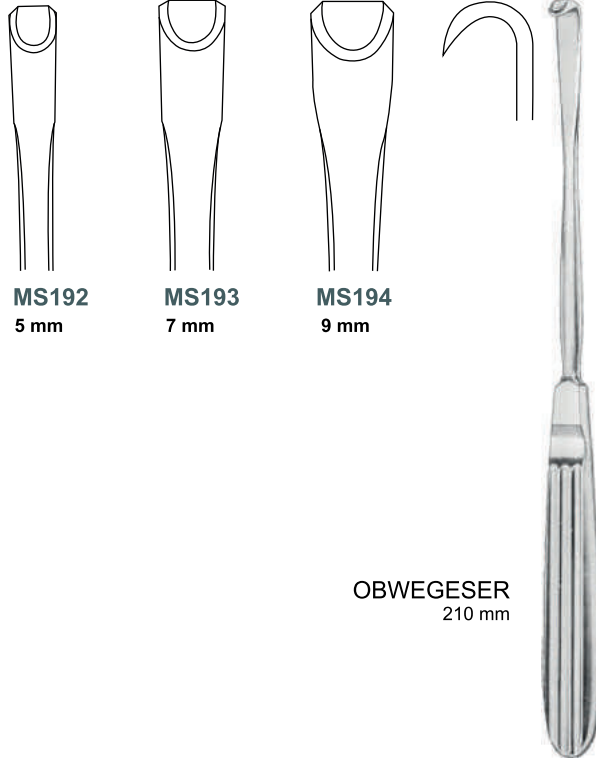

**MS192
5 mm**

**MS193
7 mm**

**MS194
9 mm**

**OBWEGESER
210 mm**

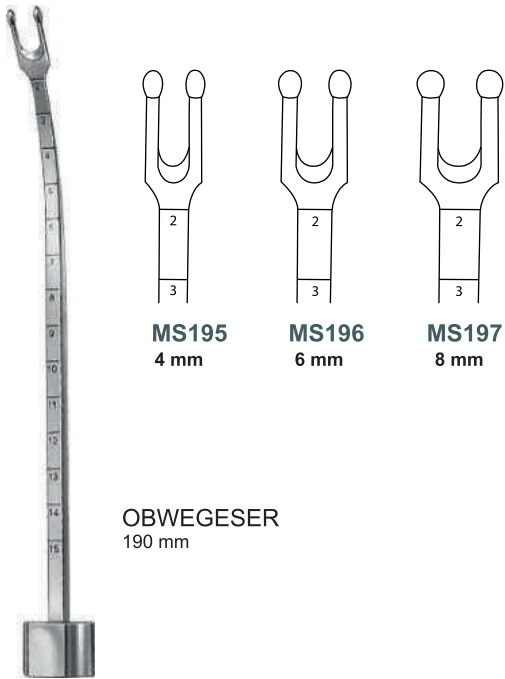

**MS195
4 mm**

**MS196
6 mm**

**MS197
8 mm**

**OBWEGESER
190 mm**



**MS198
15 mm**

**MS199
20 mm**

**OBWEGESER
220 mm**

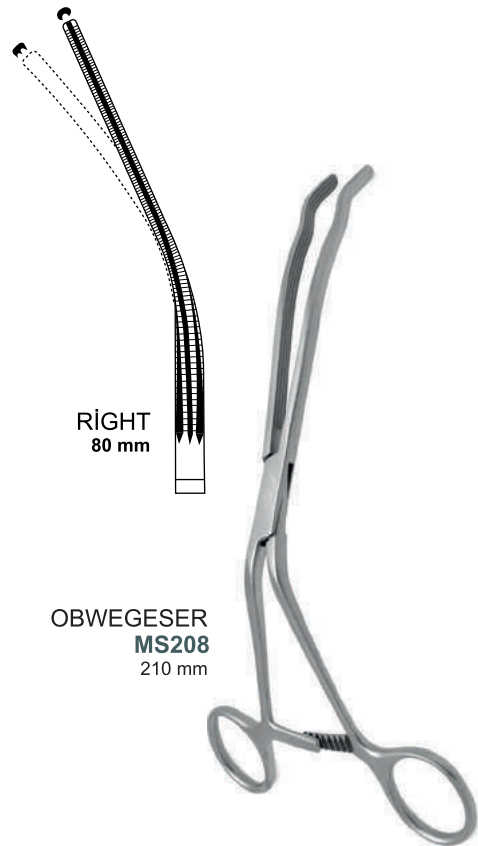
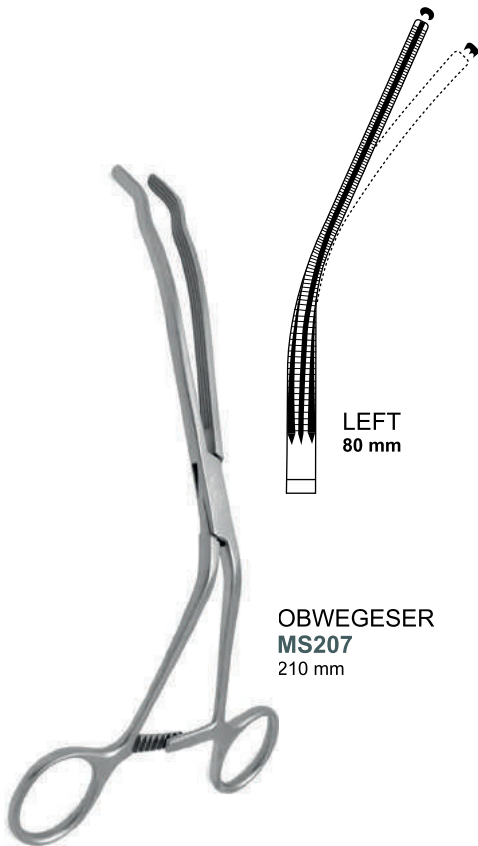
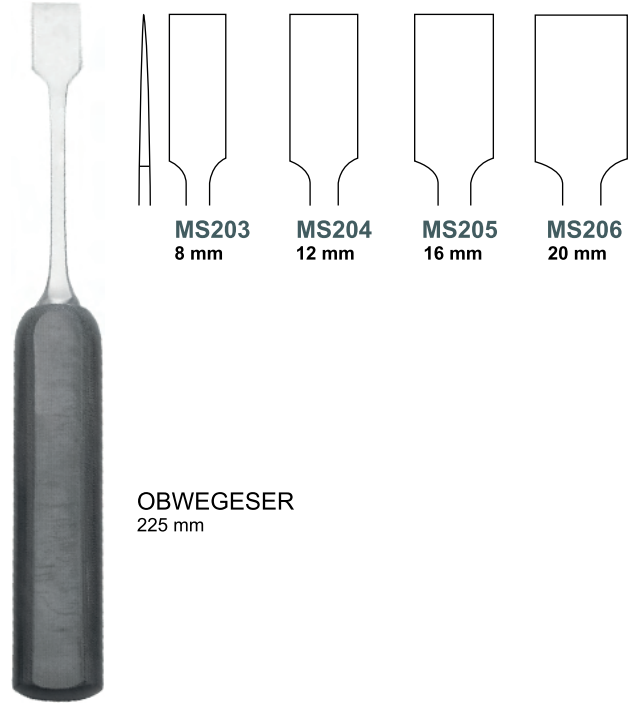
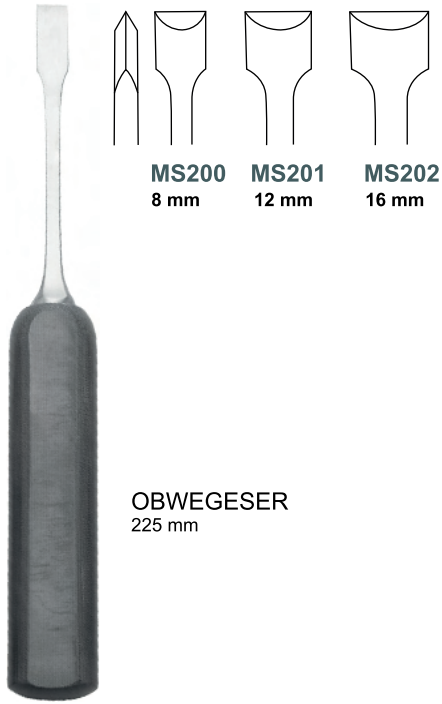

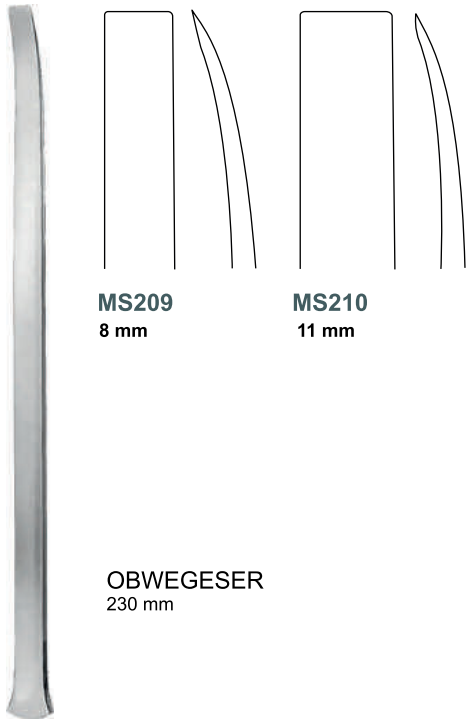

MS209
8 mm

MS210
11 mm

OBWEGESER
230 mm

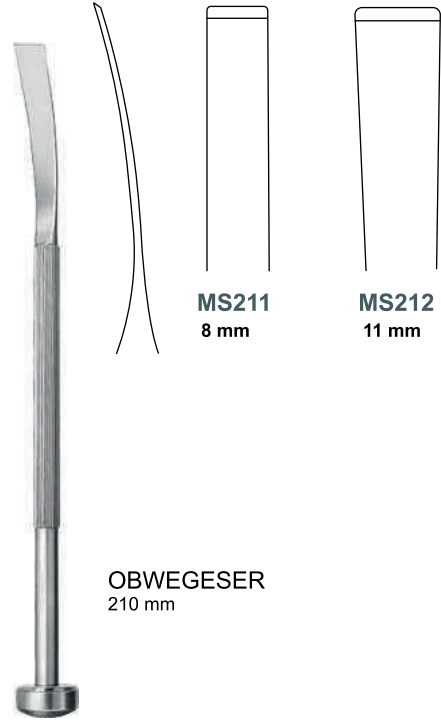

MS211
8 mm

MS212
11 mm

OBWEGESER
210 mm

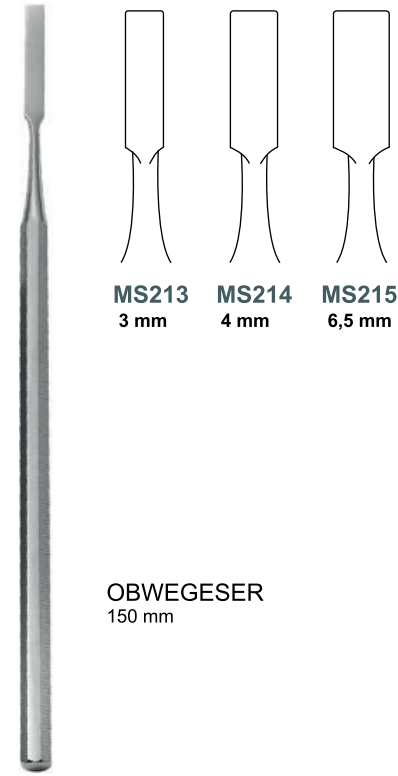

MS213
3 mm

MS214
4 mm

MS215
6,5 mm

OBWEGESER
150 mm

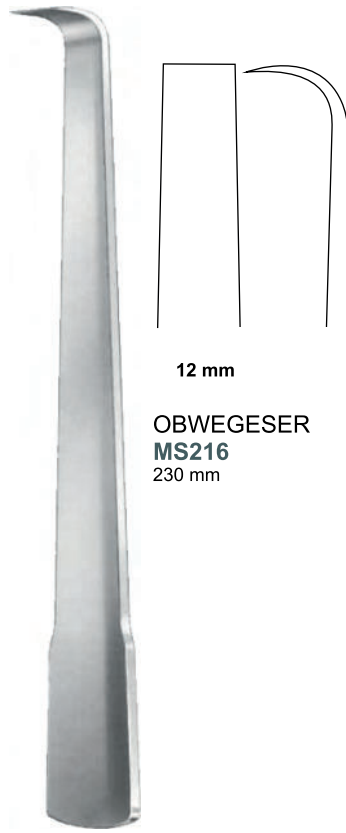

12 mm

OBWEGESER
MS216
230 mm

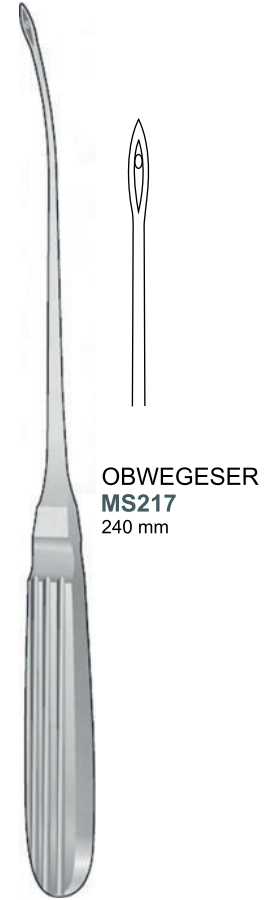

OBWEGESER
MS217
240 mm



OBWEGESER
MS218
175 mm



OBWEGESER
MS219
150 mm



TESSIER
MS220
190 mm

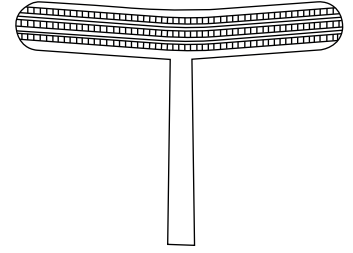
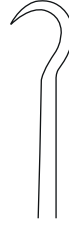

TESSIER
MS221
190 mm

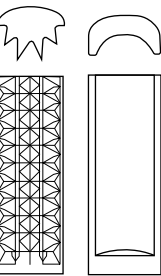

30 x 12 mm

OBWEGESER
MS222
180 mm

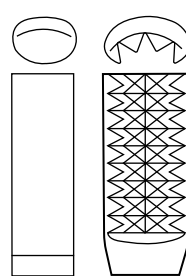

30 x 13,5 mm

OBWEGESER
MS223
180 mm

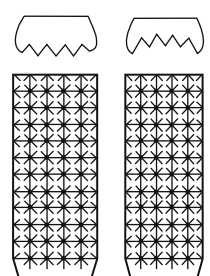
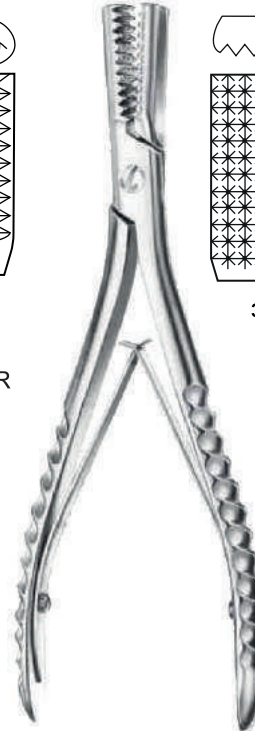

30 x 13,5 mm

OBWEGESER
MS224
180 mm



MS225 MS226

OBWEGESER
140 mm

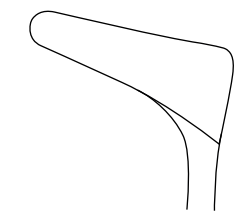
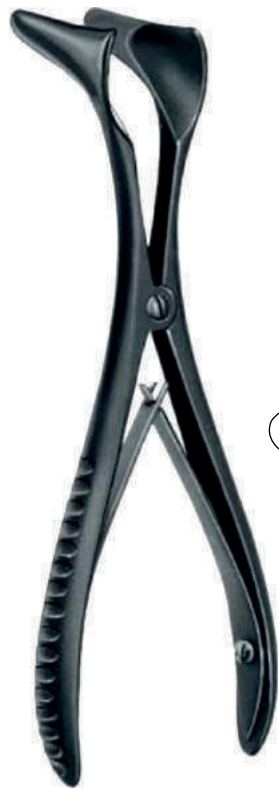

MS227
35 mm
135 mm

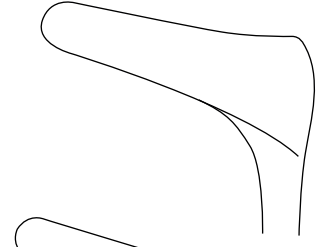

MS228
45 mm
140 mm

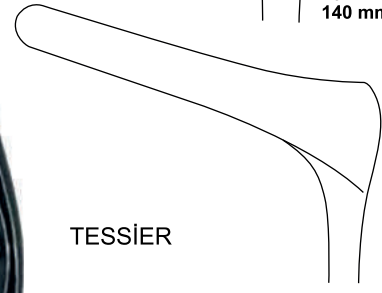

MS229
70 mm
155 mm

TESSIER



MS230
2 mm



MS231
3 mm



MS232
5 mm



MS233
7 mm



MS234
10 mm



MS235
14 mm



MS236
16 mm



MS237
5 mm



MS238
7 mm



MS239
10 mm

TESSIER
160 mm

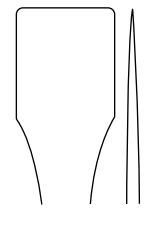

18 mm

TESSIER
MS240
160 mm

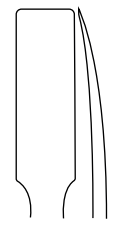

10 mm

TESSIER
MS241
180 mm

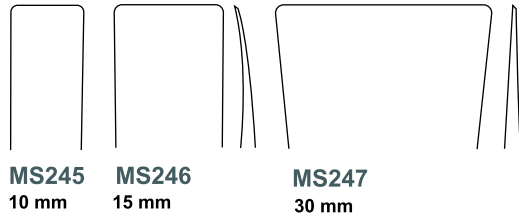
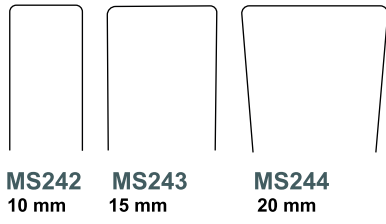

TESSIER
200 mm

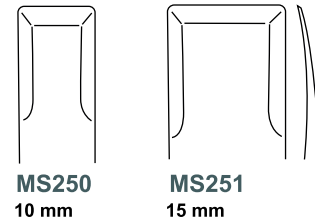
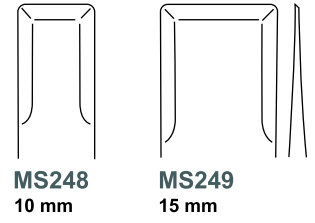

TESSIER
200 mm



MS252
210 mm
90 x 22 mm

MS253
265 mm
120 x 28 mm

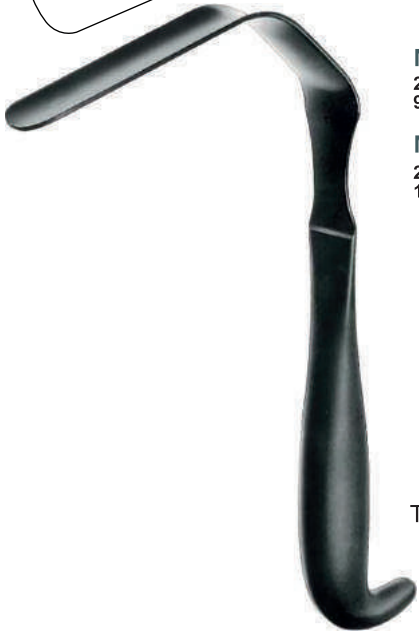

TESSIER



TESSIER

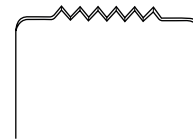

MS254
165 mm
36 x 50 mm

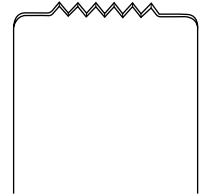

MS255
175 mm
52 x 50 mm

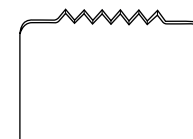

MS256
175 mm
59 x 50 mm

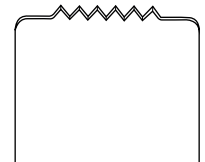

MS257
180 mm
66 x 50 mm



TESSIER
MS258
165 mm



TESSIER
MS259
180 mm

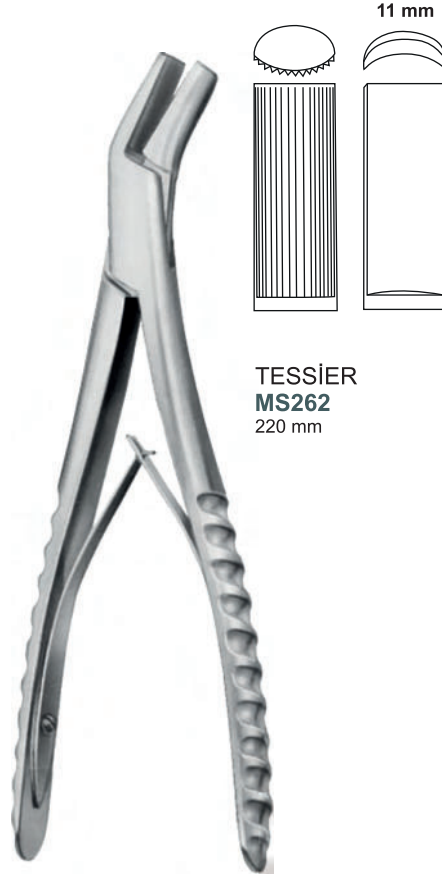

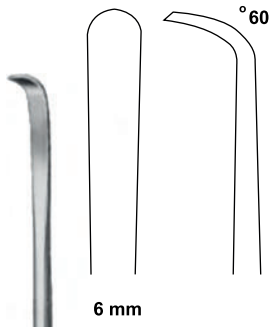

TESSIER
MS264
180 mm

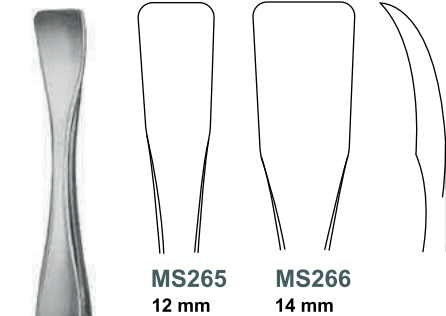

TESSIER
205 mm



TESSIER
MS267
210 mm
Ø 2,5 mm



TESSIER
MS268
165 mm
Ø 2,0 mm



TESSIER
MS269
140 mm
Ø 2,0 mm

TESSIER
MS270
220 mm
20 - 22 mm



TESSIER
MS271
220 mm
15 - 17 mm



TESSIER
MS272
220 mm
10 - 12 mm



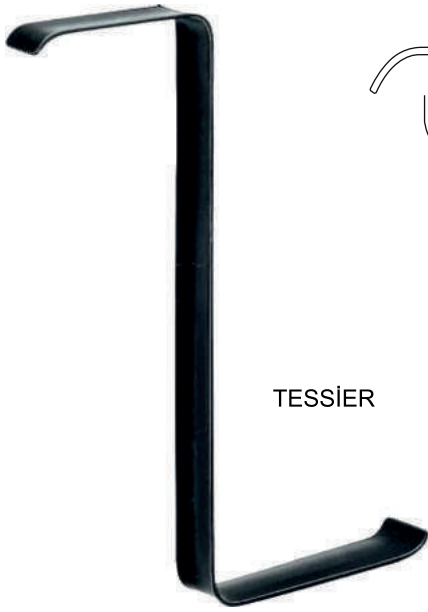

TESSIER

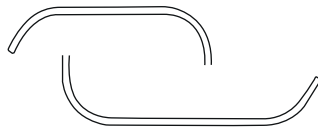

MS273
150 mm
30x12 / 38x16 mm

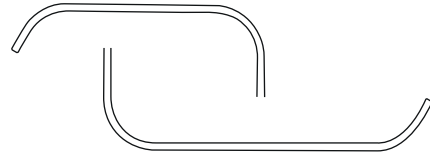

MS274
150 mm
35x12 / 45x16 mm

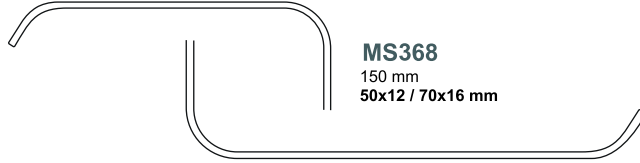

MS368
150 mm
50x12 / 70x16 mm



MS276
150 mm
20x13 / 30x15 mm



MS277
155 mm
28x13 / 36x15 mm



MS275
19x7 / 29x10 mm

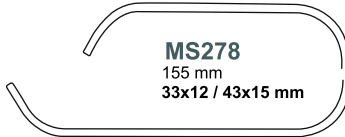

MS278
155 mm
33x12 / 43x15 mm

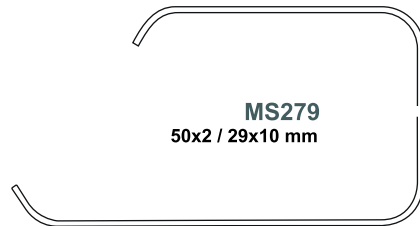

MS279
50x2 / 29x10 mm



TESSIER
205 mm



TESSIER
205 mm



TESSIER
205 mm



TESSIER
MS280
190 mm



TESSIER
MS281
180 mm



MS282
220 mm



TESSIER
MS283
190 mm

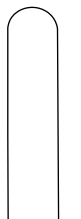

Fig.1
MS284
8 mm



Fig.2
MS285
10 mm



Fig.3
MS286
7 mm

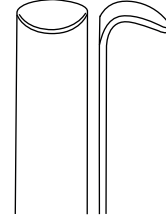

Fig.4
MS287
10 mm



Fig.5
MS288
8 mm

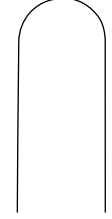

Fig.6
MS289
12 mm



TESSIER
125 mm



TESSIER
125 mm

TCGOLD

TCGOLD

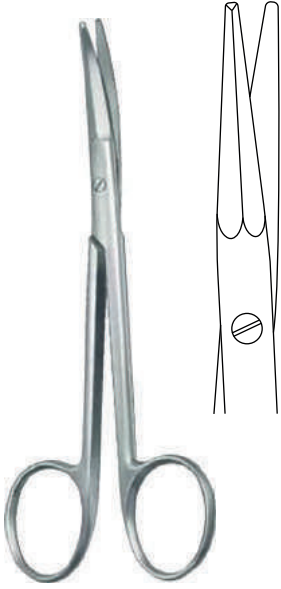

TESSIER
MS290
130 mm

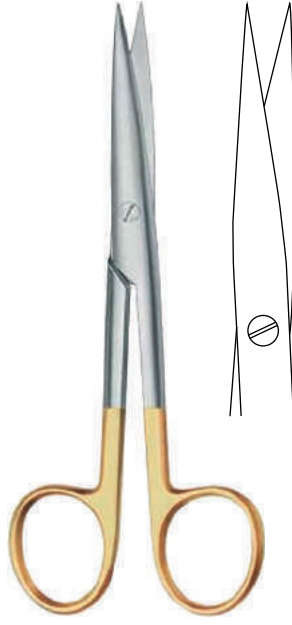

TESSIER
MS291
150 mm

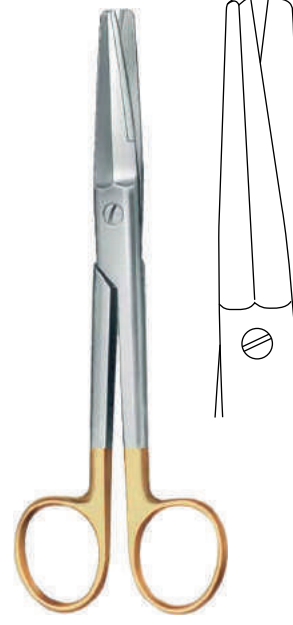

TESSIER
MS292
165 mm



TESSIER
230 mm

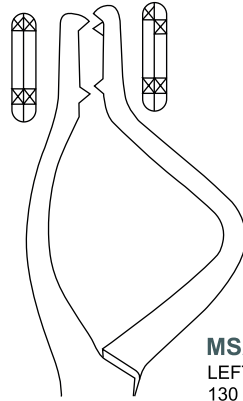

MS293
LEFT / ÇOCUK
130 mm

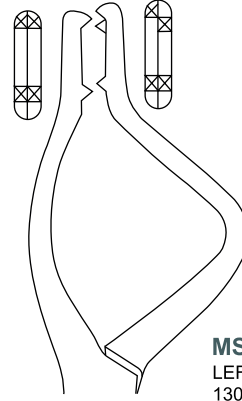

MS294
LEFT / YETİŞKİN
130 mm

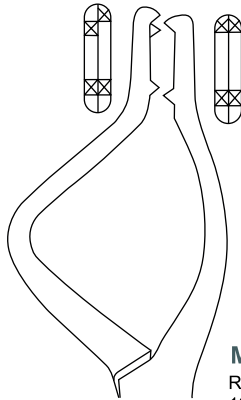

MS295
RIGHT / ÇOCUK
130 mm

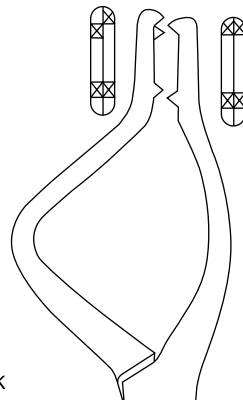

MS296
RIGHT / YETİŞKİN
130 mm



MARCHAC
MS297
170 mm



MARCHAC
MS298
160 mm



TESSIER
MS299
170 mm



TESSIER
MS300
200 mm



MARCHAC
MS301
170 mm



STEINBERG
MS302
180 mm



STEINBERG
MS303
195 mm



MARCHAC
MS304



MARCHAC
MS305

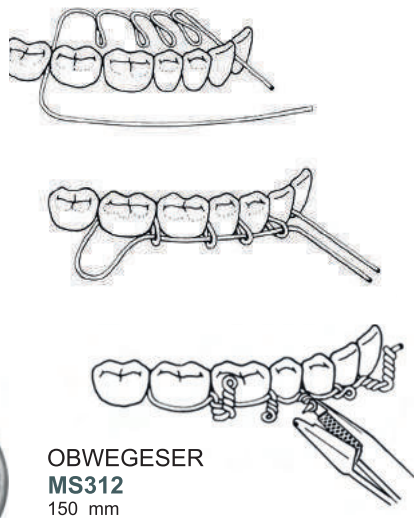
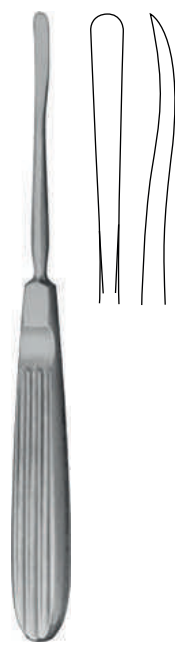
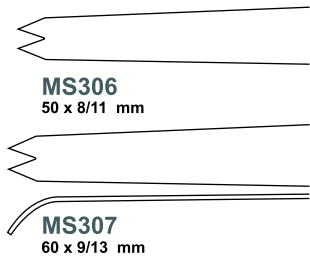

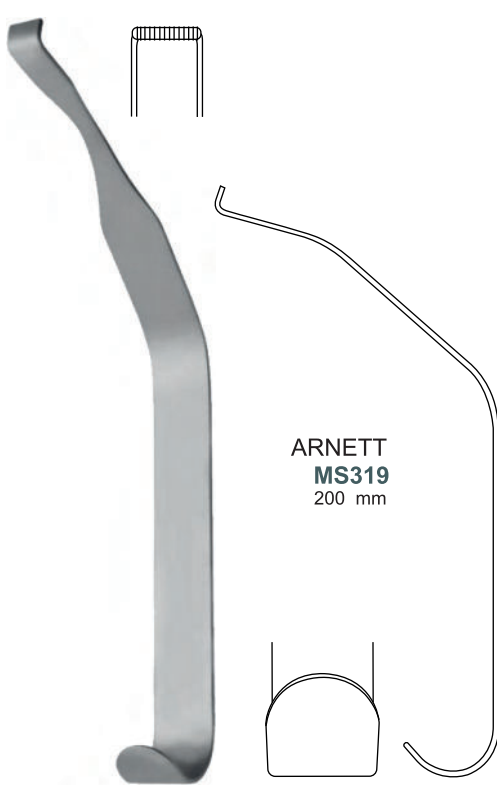
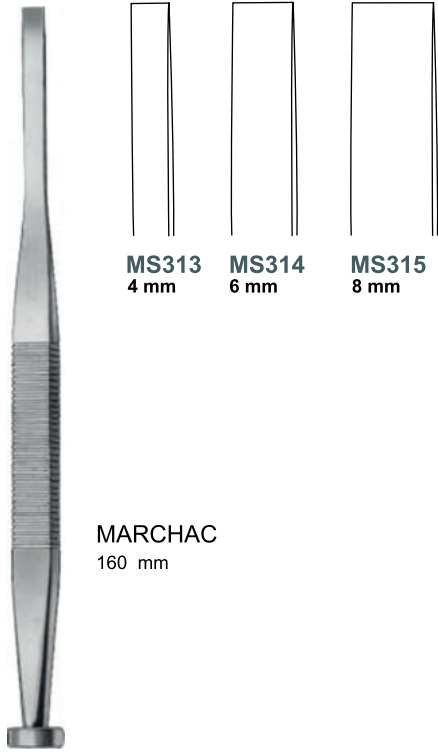



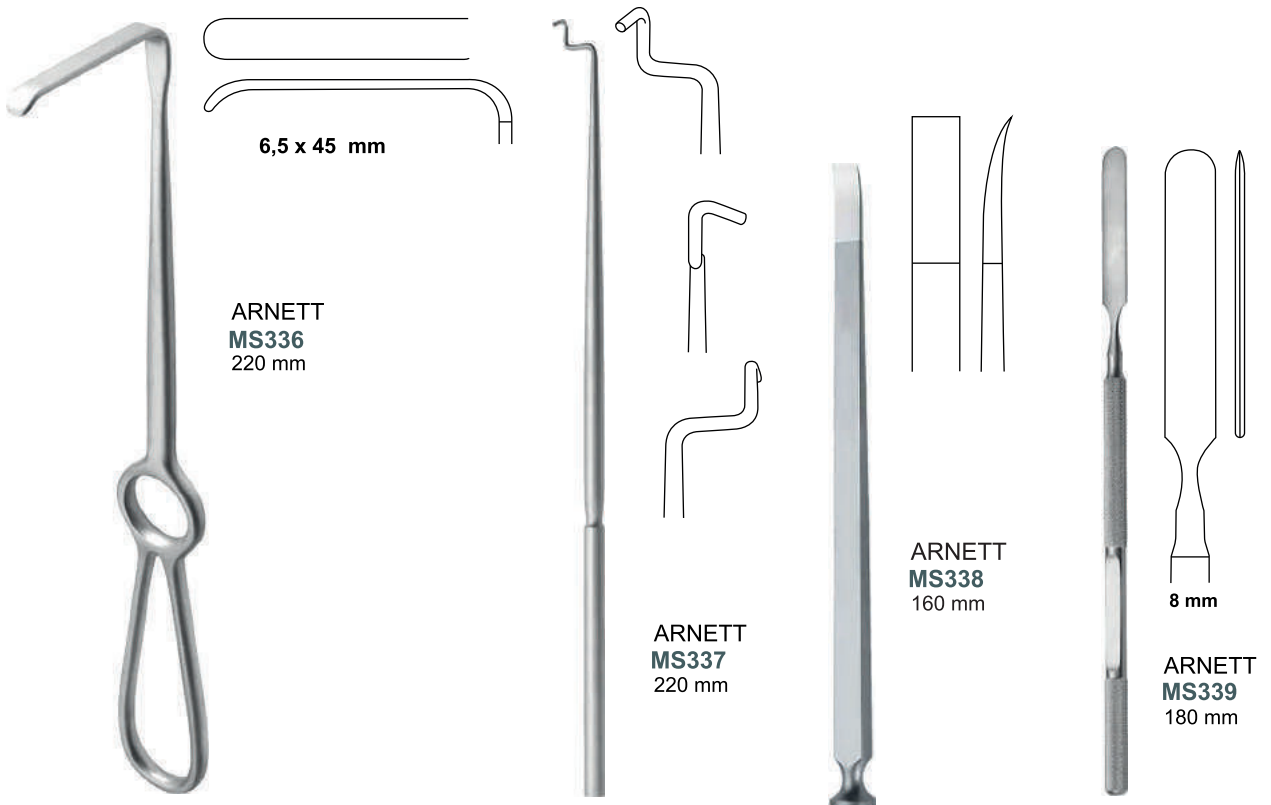
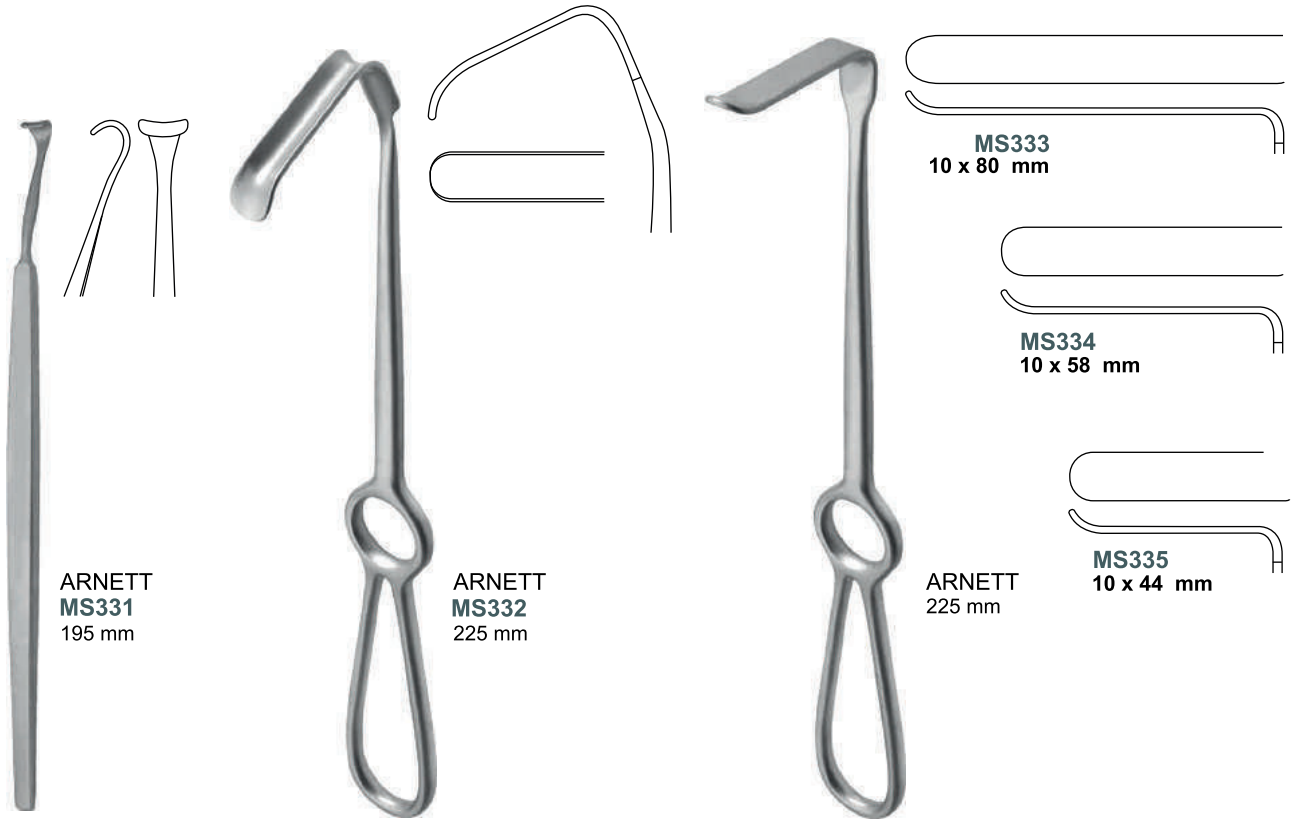

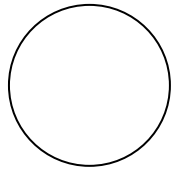

Ø = 25 mm - 360 gr

ARNETT MS340
200 mm

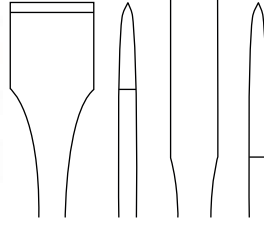

MS341
7 mm

MS342
14 mm

ARNETT
200 mm

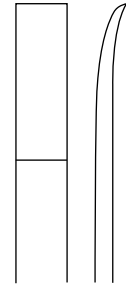
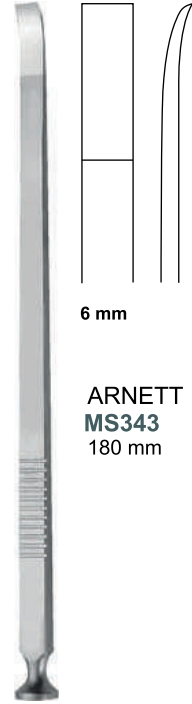

6 mm

ARNETT MS343
180 mm

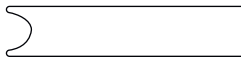
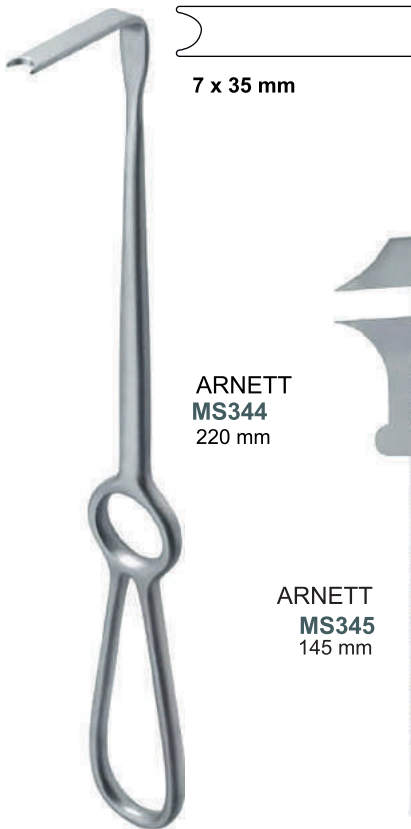

7 x 35 mm

ARNETT MS344
220 mm

ARNETT MS345
145 mm



ARNETT MS346
125 mm

ARNETT MS347
130 mm



ARNETT
MS348
210 mm



ARNETT
MS349
240 mm



8,5 mm

ARNETT
MS350
190 mm

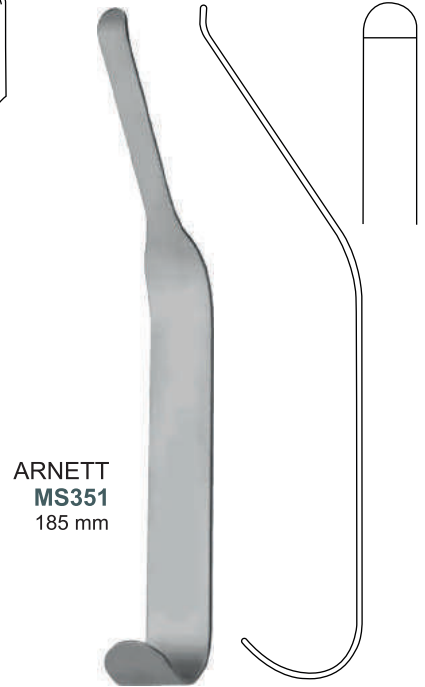

ARNETT
MS351
185 mm



LINDORF
MS352
180 mm

Bıçaklar için Vida Bladers for screws	
Cross Drive	
1,5 mm	● ⊕
2,0/2,3 mm	● ⊕
2,7 mm	● ⊕
Cross Drive	
1,5 mm	● ⊕
2,0/2,3 mm	● ⊕
2,7 mm	● ⊕



LINDORF
MS353
180 mm



ARNETT
MS354
185 mm

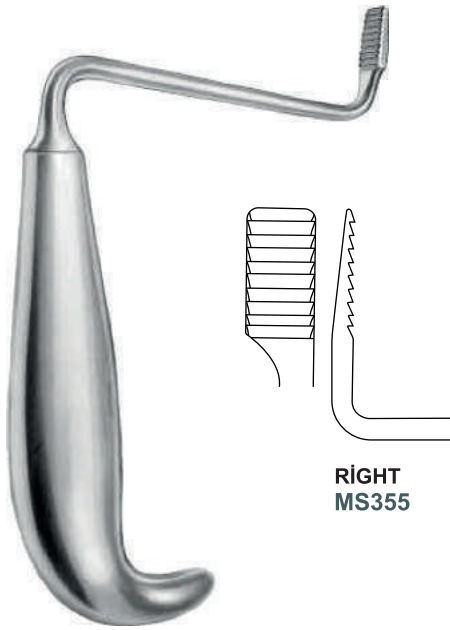

RIGHT
MS355

TESSIER
150 mm

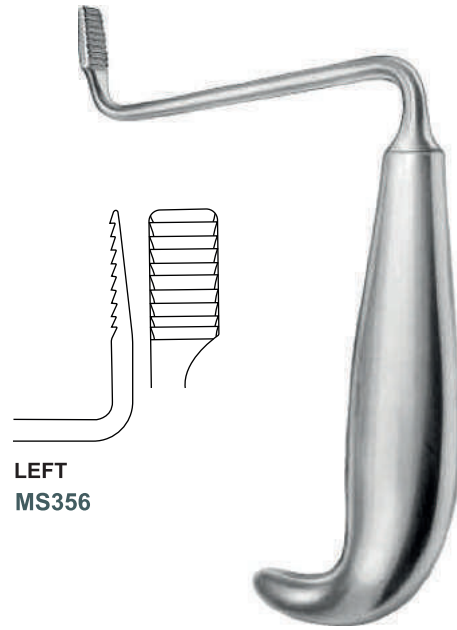

LEFT
MS356

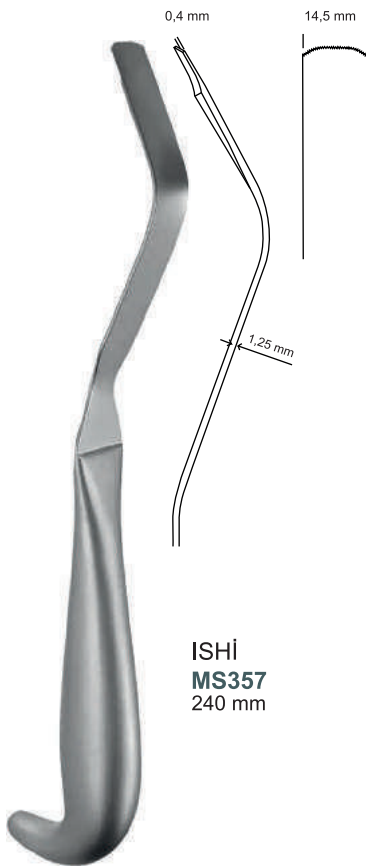

ISHİ
MS357
240 mm



ISHİ
MS358
195 mm



ISHİ
MS359
230 mm



ISHİ
MS360
245 mm



OBWEGESER
MS361
130 mm



OBWEGESER
MS362
120 mm



OBWEGESER

MS363
125 mm



MS364
130 mm



MS365
150 mm



STAMMBERGER
MS366
10 cm



WEILL-BLAKES
MS367
120 mm

ORTODONTİ ORTHODONTICS

Küçük nesnelere tutmak veya ortodontik prosedürlerde kullanılan metal şeritleri veya telleri bükmek için kullanılır. Tipik olarak yüksek kaliteli çelikten yapılır ve proksimalde bir sap oluşturan ve amaçlanan kullanıma bağlı olarak çeşitli şekillerde mevcut olan çenelerle sonlanmak üzere bir pivot noktası boyunca distal olarak uzanan iki koldan/çubuktan oluşur.

It is used to hold small objects or bend metal strips or wires used in orthodontic procedures. It is typically made of high-grade steel and consists of two arms/rods that form a handle proximally and extend distally through a pivot point to terminate with jaws available in various shapes depending on intended use.



ERSOY
DENTAL

ODC
CERRAHI ALETLER







0,5 mm Tel için Uygundur.
OD013
Flush Distal Kesici
1/1



0,5 mm Tel için Uygundur.
OD014
Flush Distal Kesici Uzun Sap
1/1



0,7 - 0,9 mm Arası için Uygundur.
OD015
Laboratuvar Sert Tel Kesici
1/1



1,0 - 1,5 mm Arası için Uygundur.
OD016
Laboratuvar Sert Tel Kesici Plastik Sap
1/1



0,5 mm'e Kadar Uygundur.

OD017
Weingart Pensi Slim

0,5 mm'e Kadar Uygundur.

OD018
Weingart Pensi

0,5 mm'e Kadar Uygundur.

OD019
Weingart Pensi Açılı
Uzun Ağızlı

0,5 mm'e Kadar Uygundur.

OD020
Weingart Pensi Açılı
Kısa Ağızlı

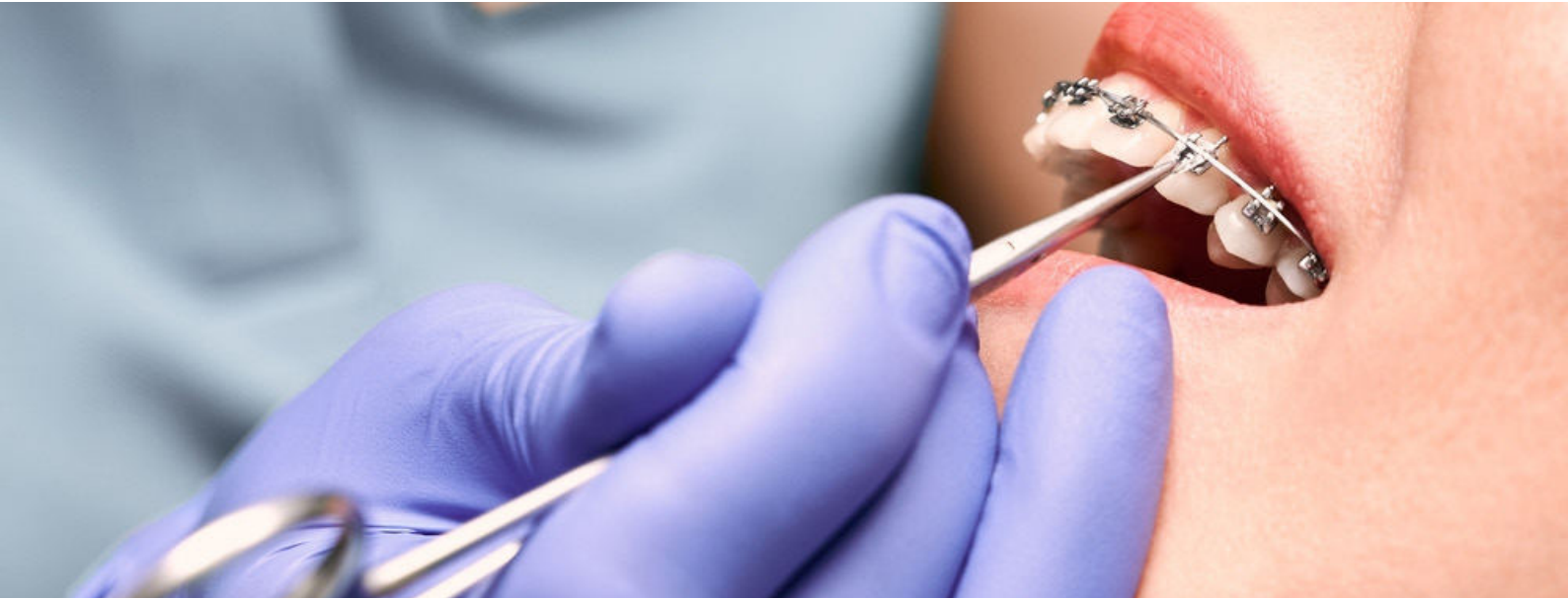



OD025
Posterior Bant Sökücü Pens Kısa
1/1



OD026
Posterior Bant Sökücü Pens Orta
1/1



OD027
Posterior Bant Sökücü Pens Uzun
1/1



OD028
Mikro Posterior Bant Sökücü
Pens Keskin
1/1



OD029
Braket ve Adhesive Sökücü Pens
1/1



OD030
Adhesive Sökücü Pens
1/1



OD031
Düz Braket Sökücü Pens
1/1



OD032
Açılı Braket Sökücü Pens
1/1



OD033
Debonding Pens Düz
1/1



OD034
Debonding Pens Eğri
1/1



OD035
Debonding Pens Kanallı
1/1



0,7 mm'e Kadar Uygundur.
OD036
Bird Beak Pens
1/1









1mm



1,0 mm'e Kadar Uygundur.

OD059
Tweed Pens

1/1

2mm



2,0 mm'e Kadar Uygundur.

OD060
Tweed Pens

1/1



OD061
Kron ve Band Pens

1/1



OD062
Reynolds Pens

1/1



OD063
Kontur Pens

1/1



1,0 mm'e Kadar Uygundur.

OD064
V-Büküm Pens

1/1





OD069
Seperetör Pensi
1/1

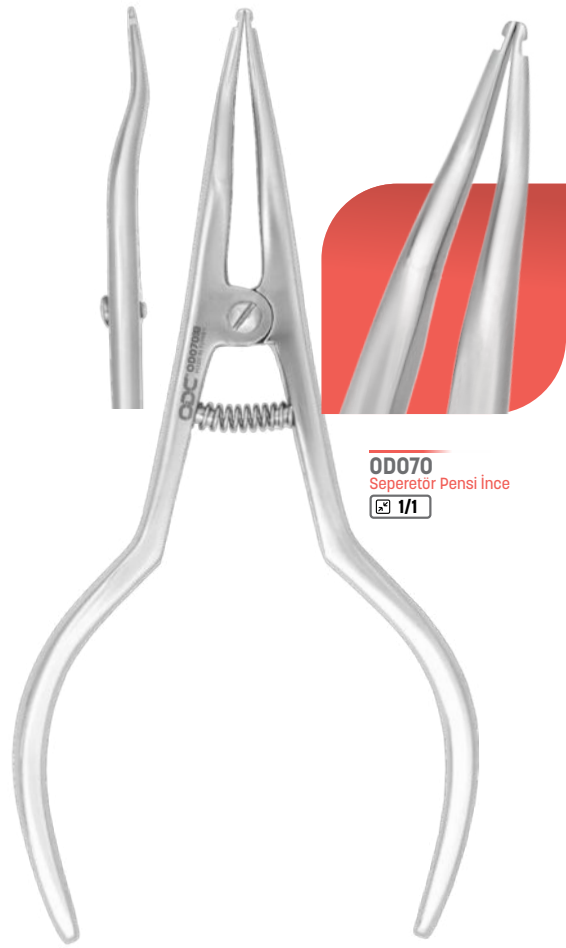

OD070
Seperetör Pensi İnce
1/1



OD071
Ligatür Bağlama Pensi
1/1



OD072
Seperetör Pensi Oval Sap
1/1



OD073
Check Ekartörü
1/1



OD074
Boone Braket Konumlandırıcı
1/1



OD075
Ivanson Kumpas
1/1



OD077-OD078

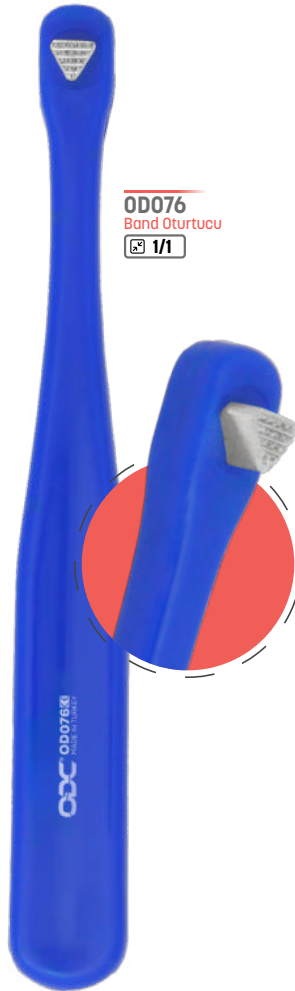

OD076
Band Oturtucu
1/1

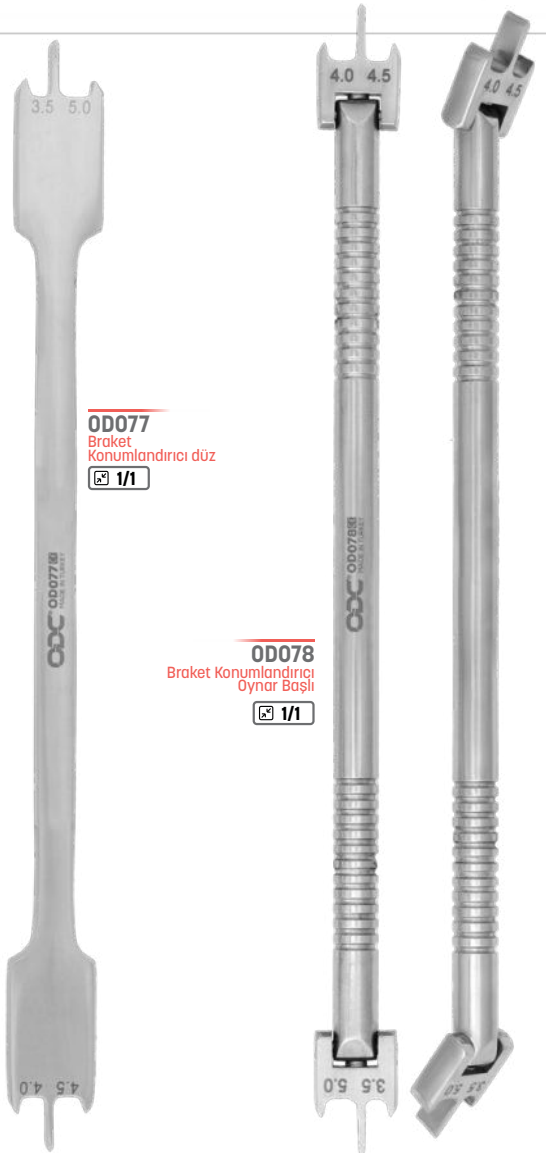

OD077
Braket Konumlandırıcı düz
1/1

OD078
Braket Konumlandırıcı Oyнар Başlı
1/1

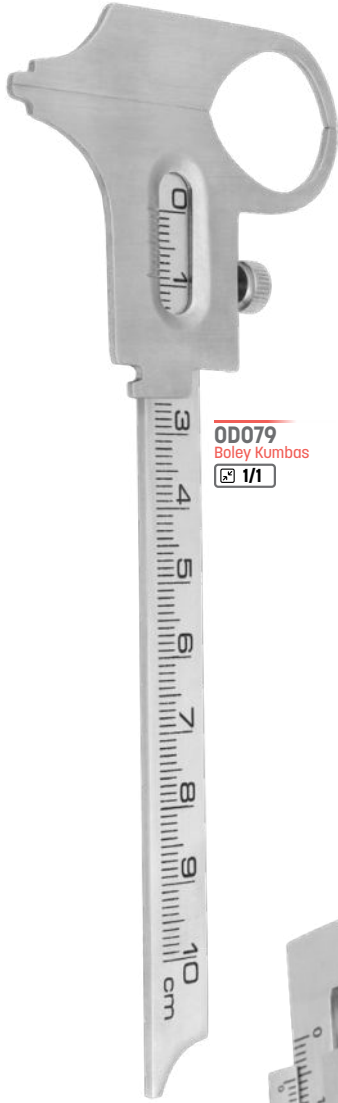

OD079
Boley Kumbas
1/1



1/1

OD081
Ligatür Takıcı
Düz ve Eğri



1/1

OD082
Ligatür Takıcı



1/1

OD083
Ligatür Takıcı
Medium



1/1

OD086
Bant Oturtucu

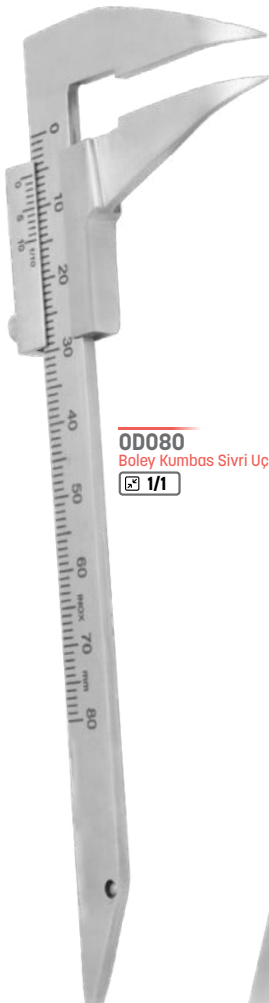

OD080
Boley Kumbas Sivri Uç
1/1



OD084
Mershon Bant İtici
1/1

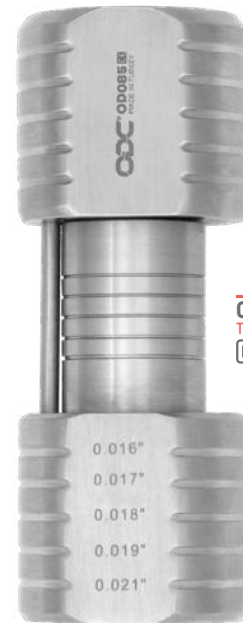

OD085
Turet
1/1





OD101
ORTODONTİ ALET STANDI



OD096
PEESO PENSI
1/1



OD097
ENDODONTİK PENSI
1/1



OD098
ENDODONTİK PENSI
1/1



OD099
LİGATÜR FORMING PENSI
1/1

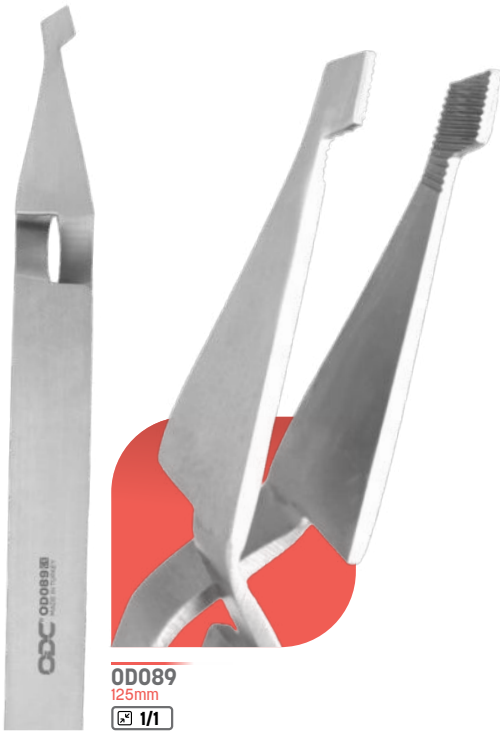



OD091
125mm
1/1



OD092
125mm
1/1



OD093
125mm
1/1



OD094
125mm
1/1

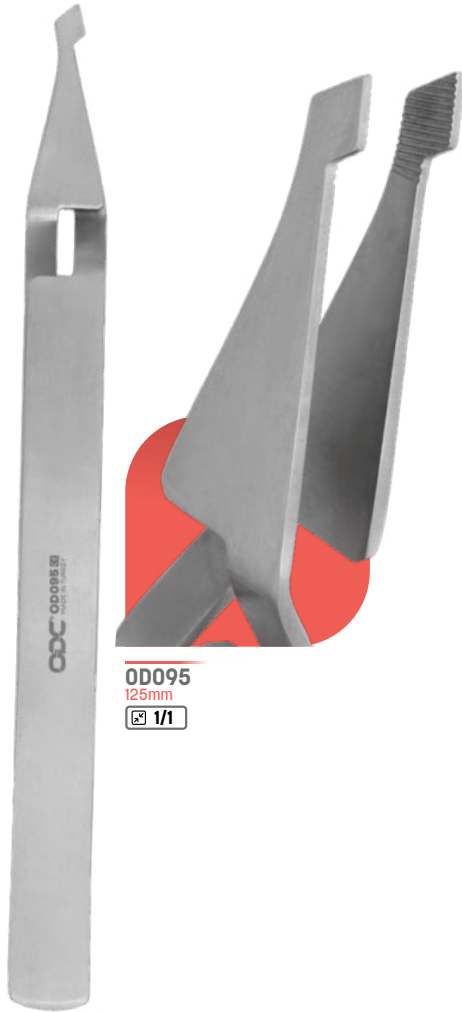

OD095
125mm
1/1



KP020
WALZWAK PENSI
1/1



KP021
KROSE PENSI
1/1

KONTEYNER SİSTEMLERİ

CONTAINER SYSTEMS

PRF Kutusu, Prf Fibrinlerin süzgeç üzerinde parçalanarak (standartlaştırılarak) zar haline gelmesine yardımcı olan paslanmaz bir kutudur.

PRF Box is a stainless box that helps Prf Fibrins to become a membrane by crushing (standardizing) on the strainer.



ERSOY
DENTAL

ODC
CERRAHI ALETLER

**B1-001**

1/1 Bio-Barrier Model

W:285mm x L:600mm

Kapak (Bariyer ile)
Kutu (Deliksiz)

**D1-074**

Dental Model

W:325mm x L:192mm x h:55mm

Kapak (Delikli)
Kutu (Deliksiz)**D1-080**

Dental Model

W:325mm x L:192mm x h:135mm

Kapak (Delikli)
Kutu (Deliksiz)**D1-086**

Dental Model

W:325mm x L:192mm x h:135mm

Kapak (Delikli)
Kutu (Deliksiz)**Tel Sepet Kapaksız**

W:270mm x L:170mm x h:45mm

Slikon Çim

W:260mm x L:180mm

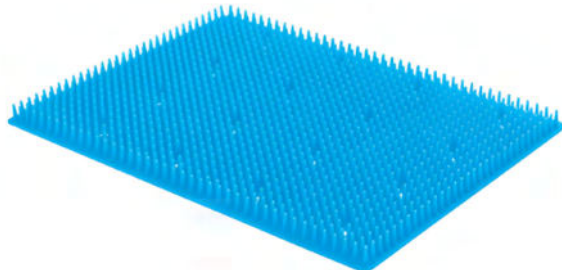



K1-001
PRF BOX FOR PROFESIONAL USE
W:90mm x L:180mm x h:40

PRF System

Dental Implant PRF Sistemi Platelet Zengin Fibrin kutusu, daha hızlı cerrahi operasyonlara imkan veren birden fazla P.R.F'yi yapmak için çok kullanışlı bir sistemdir.



K1-003
09 - HOLES
K1-004
12 - HOLES



K1-005
12 HOLES



K1-006
12 HOLES



K1-007
W:68mm x L:60mm x h:20



K1-008
W:110mm x L:75mm x h:5

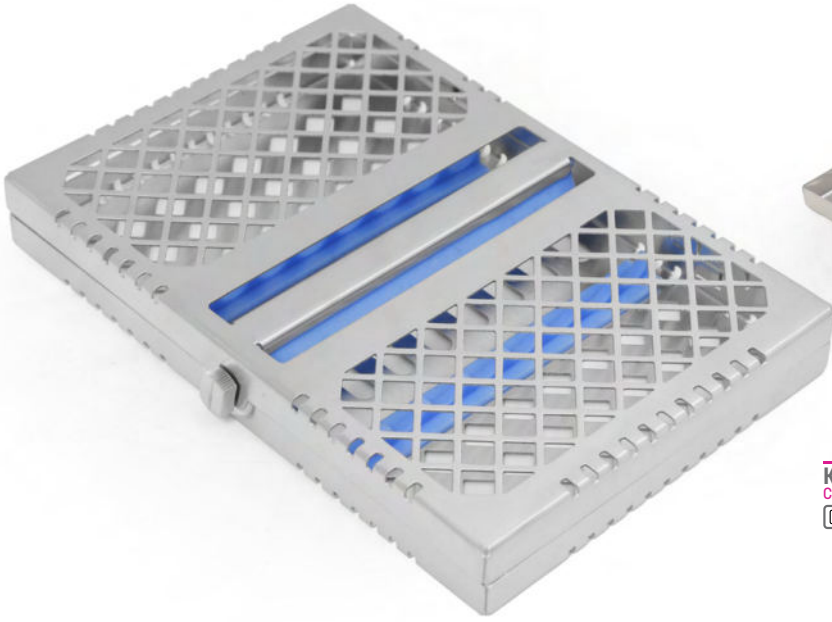

K1-009
C:65mm x h:30

**K1-017**
CASSETTE FOR 7

W:220mm x L:125mm x h:25mm

**K1-018**
CASSETTE FOR PRF

W:220mm x L:200mm x h:34mm





K1-019
MESH CASSETTE - 05 CASSETTE
W:195mm x L:80mm x h:32mm



K1-020
MESH CASSETTE - 07 CASSETTE
W:195mm x L:105mm x h:32mm



K1-021
MESH CASSETTE - 10 CASSETTE
W:195mm x L:140mm x h:32mm

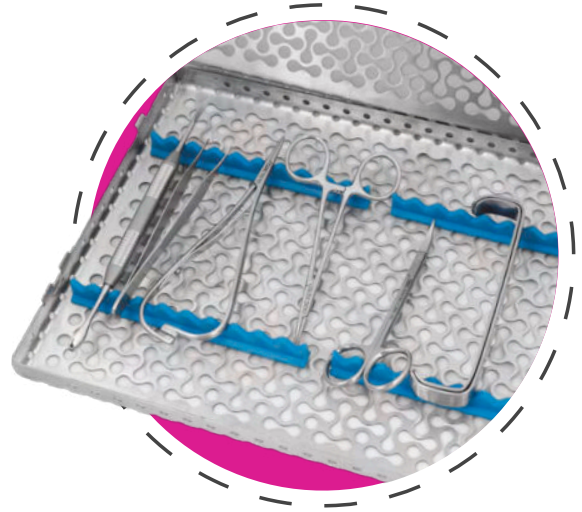
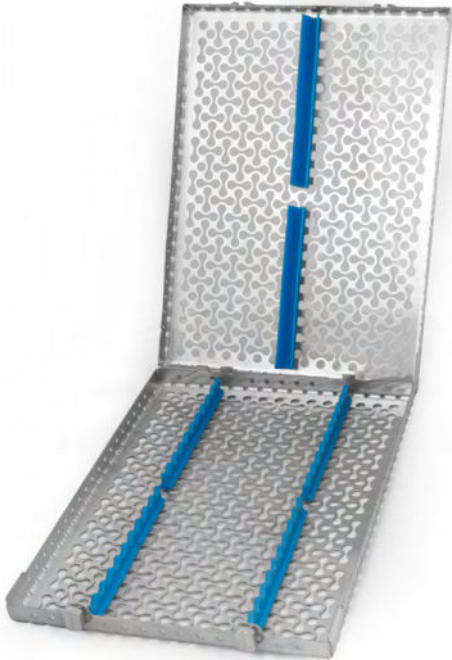

K1-022
MESH CASSETTE - 20 CASSETTE
W:280mm x L:195mm x h:32mm

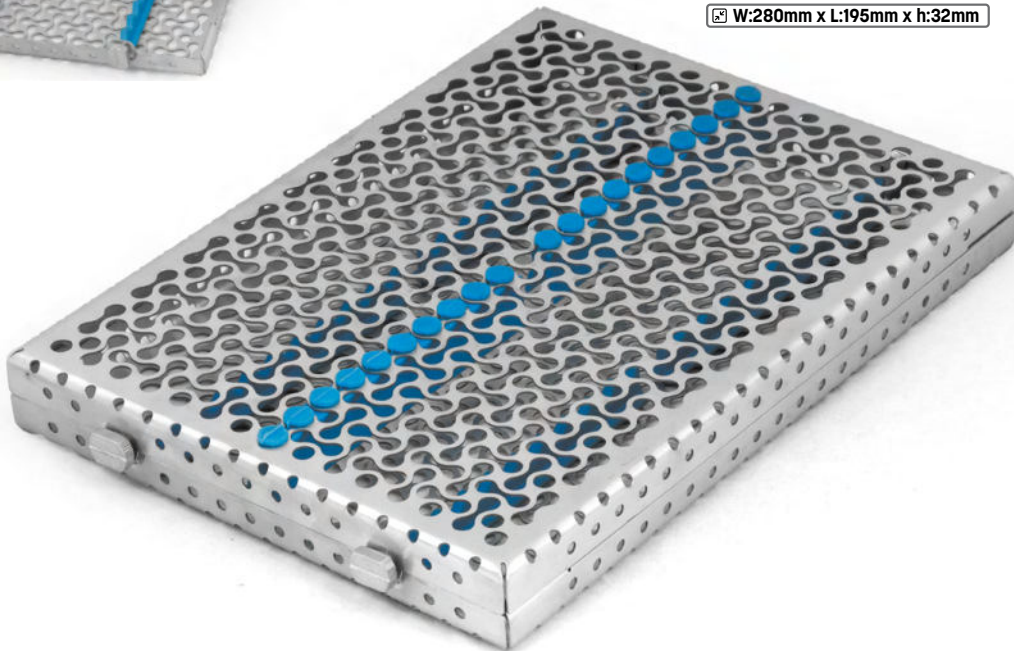



K1-023
ELONGATED CASSETTE - 05 CASSETTE
W:190mm x L:76mm x h:30mm

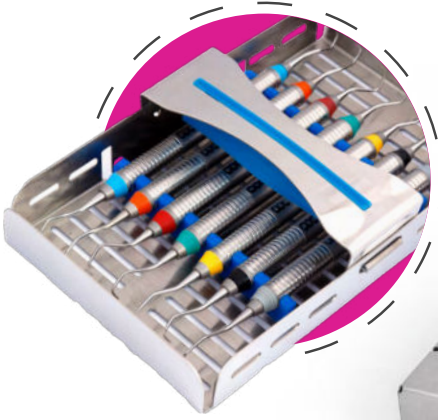

K1-024
ELONGATED CASSETTE - 05 CASSETTE
W:190mm x L:102mm x h:30mm



K1-025
ELONGATED CASSETTE - 10 CASSETTE
W:190mm x L:142mm x h:30mm

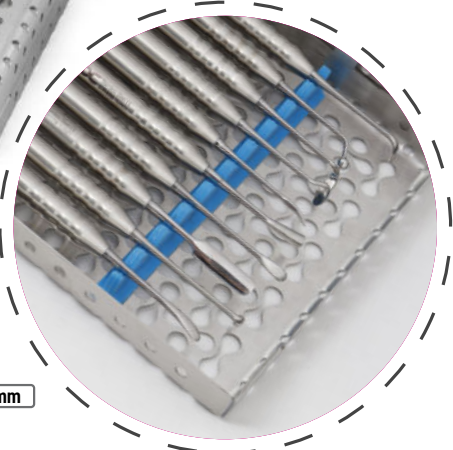

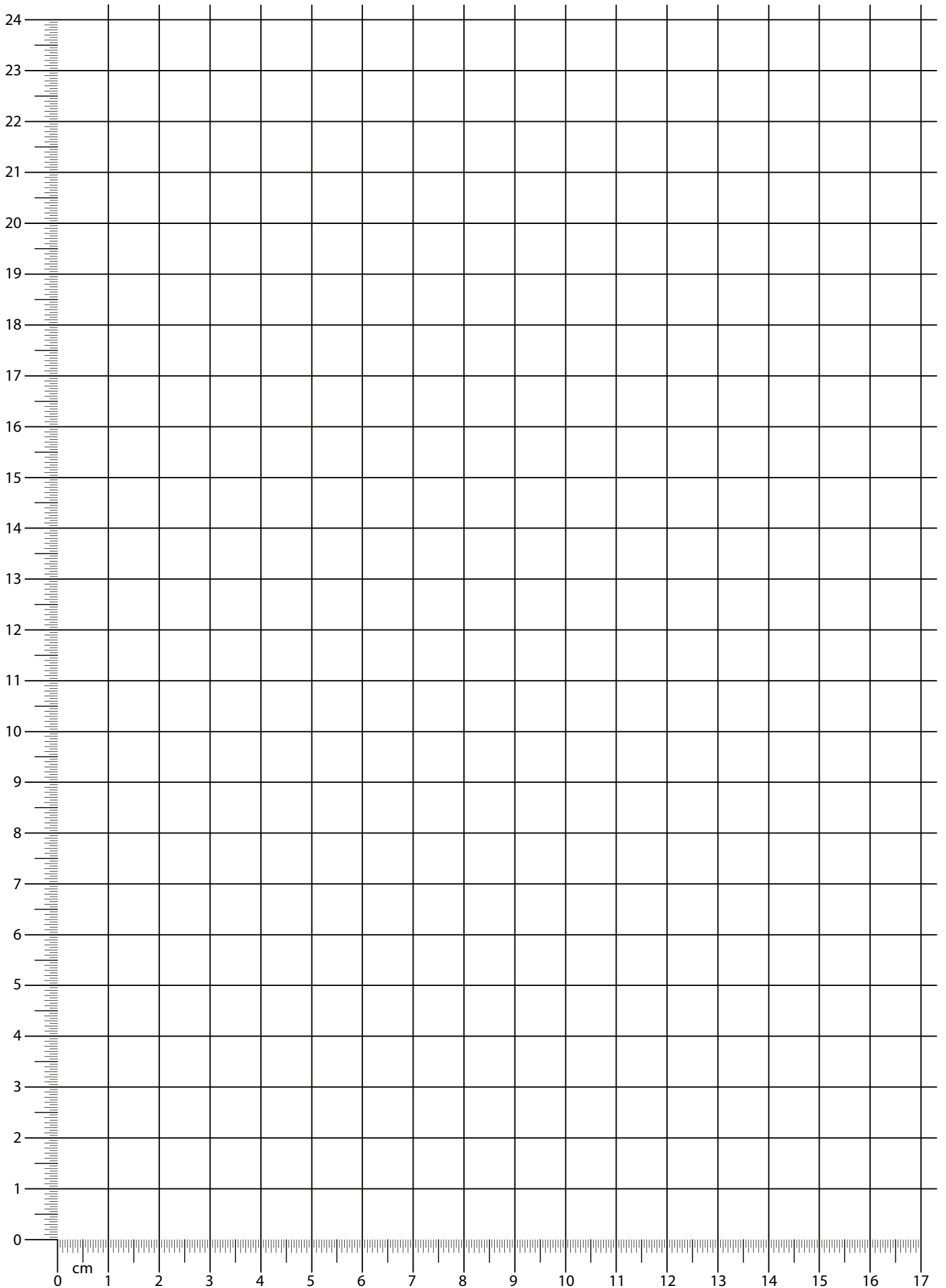

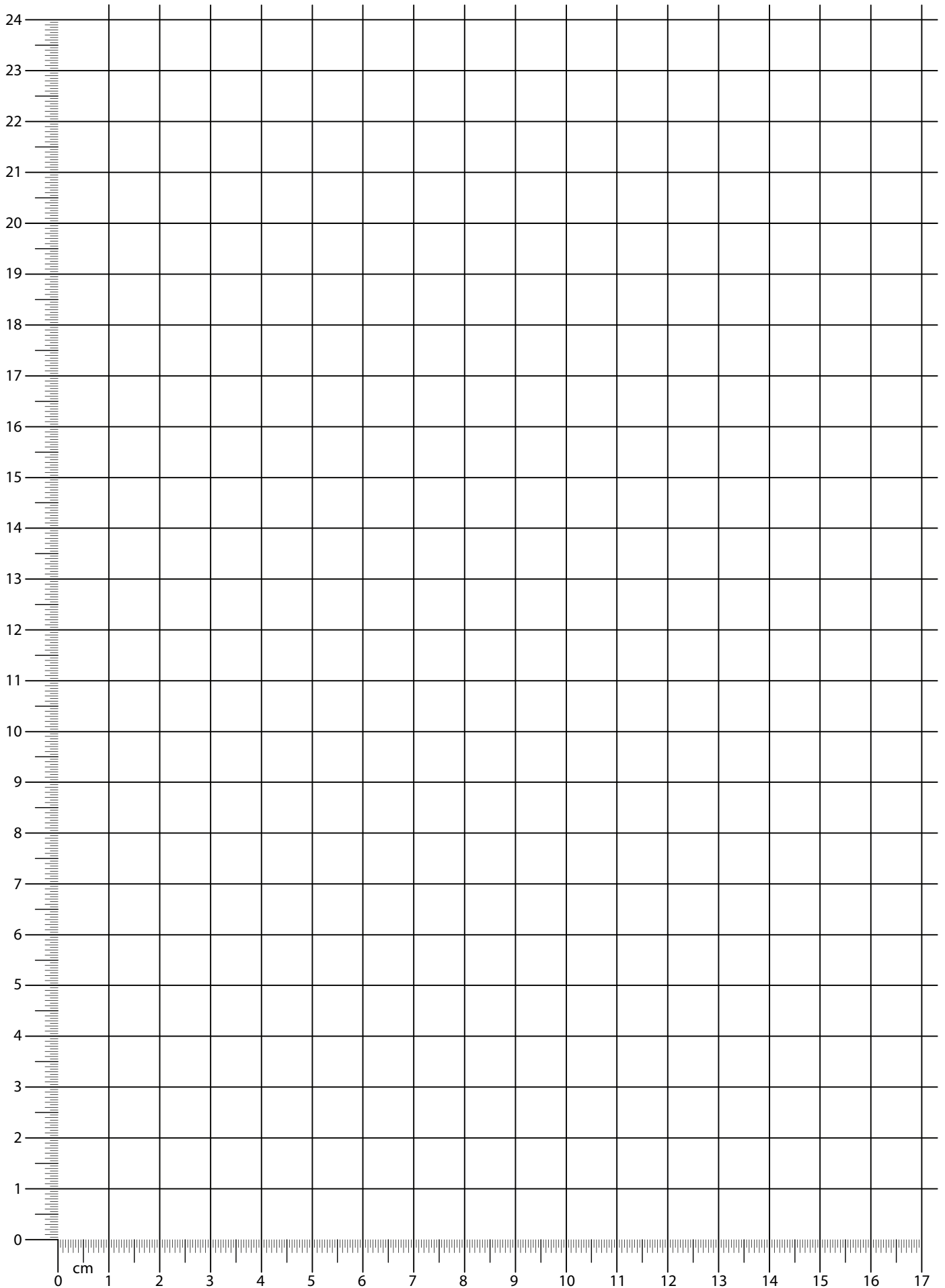

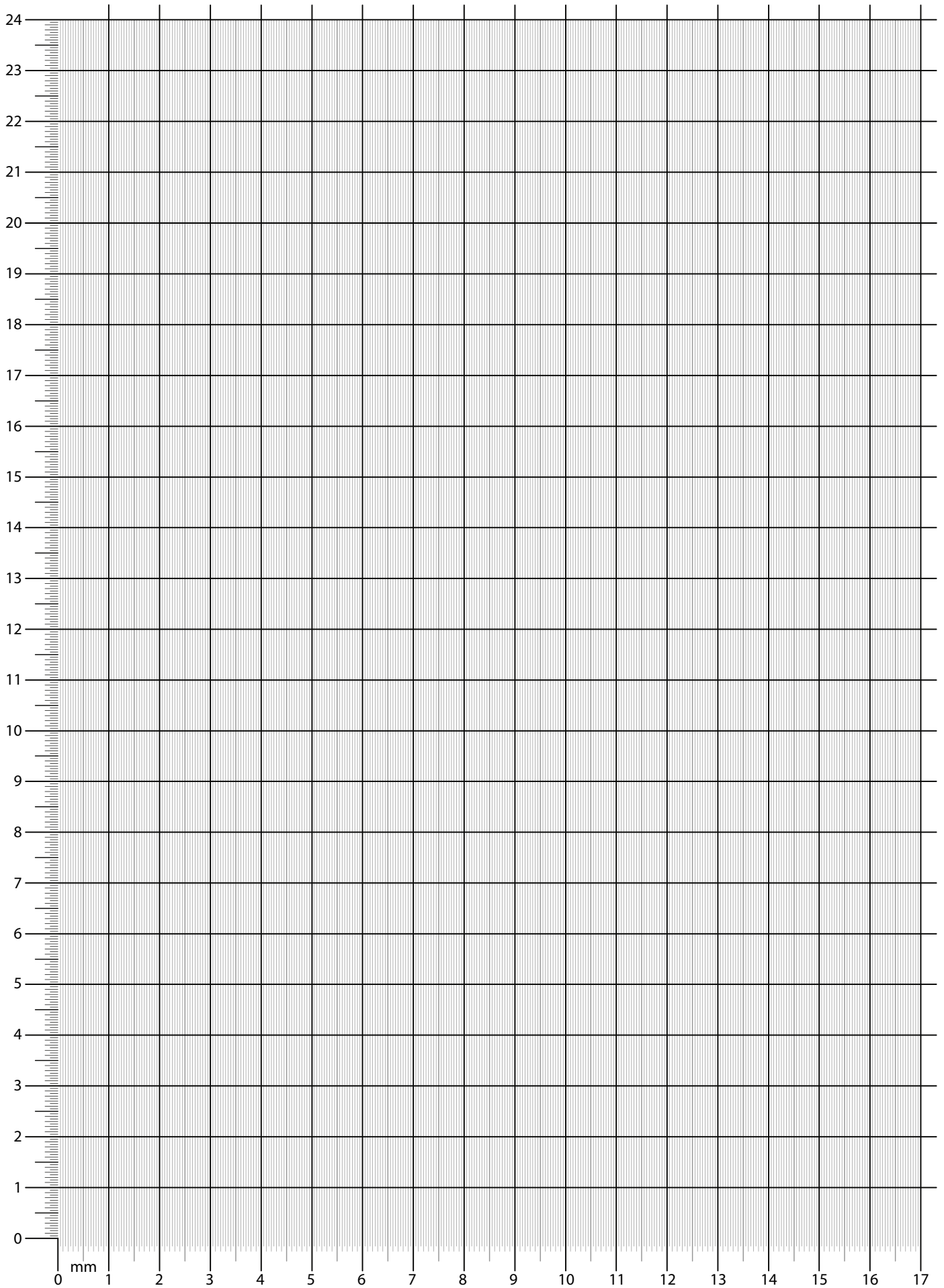

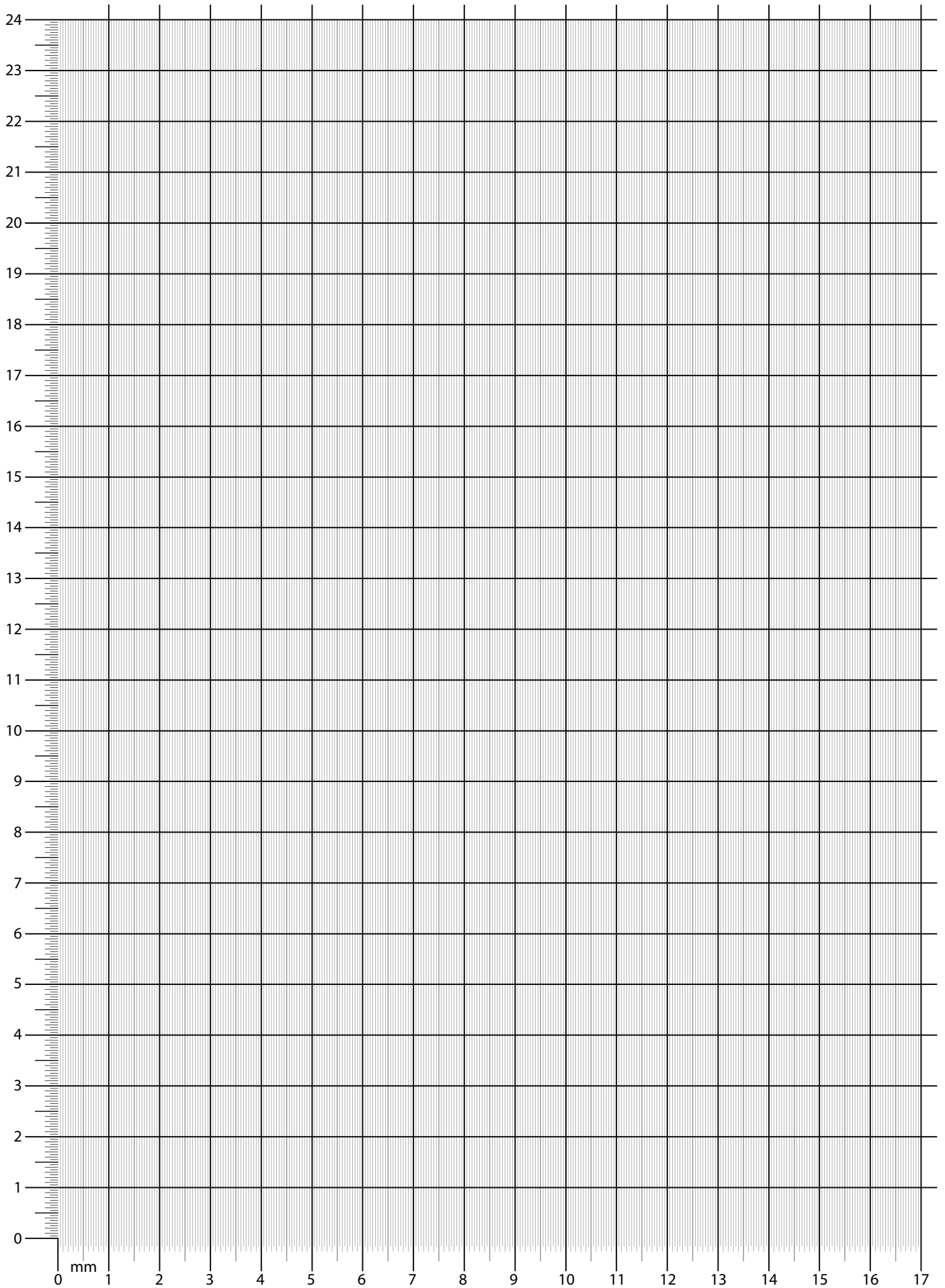

Ürün Kodu
FC002

ERSOY / ODC



ERSOY / ODC

**Gülümsemeleri Güçlendiriyoruz: Cerrahi Diş
Aletleriyle Sağlık Dolu Bir Gelecek!**

Enhancing Smiles: A Healthy Future with Surgical Dental Instruments!



 **ONUR DENTAL**

ERSOY
DENTAL

ERSOY
LOGISTIC

ERSOY
GAYRİMENKUL A.Ş.

► ersoydental.com

   @ersoydental

ERSOY / ODC



İletişim Bilgileri | Contact information

+90 362 231 34 34

info@ersoydental.com

İstiklal, İlkadım Sanayi
Bölgesi, 53. Sk. No:39
Tekkeköy/Samsun

**Türkiye'nin
Tek Dental Cerrahi
El Aleti Üreticisi**

Turkey's Only Dental Surgical
Instruments Manufacturer.

 **ONUR DENTAL**

ERSOY
DENTAL

ERSOY
LOGISTIC

ERSOY
GAYRİMENKUL A.Ş.

▶ ersoydental.com

[f](#) [@](#) [in](#) @ersoydental

Ürün Kataloglarımızı
İncelemek İçin Qr Kodu
Okutunuz

